





Agency Approvals

AGENCY	AGENCY FILE NUMBER
	E230531

Maximum Ratings and Thermal Characteristics (T_A=25°C unless otherwise noted)

Parameter	Symbol	Value	Unit
Peak Pulse Power Dissipation 1. 100µs x 150ms test waveform	P _{PPM}	2200	W
2. 8 x 20µs test waveform		50000	W
Steady State Power Dissipation on infinite heat sink at T _L =75°C (Fig. 5)	P _{M(AV)}	8.0	W
Maximum Instantaneous Forward Voltage at 100A for Unidirectional only	V _F	3.5	V
Operating Junction and Storage Temperature Range	T _J , T _{STG}	-65 to 175	°C
Typical Thermal Resistance Junction to Lead	R _{UJL}	8.0	°C/W
Typical Thermal Resistance Junction to Ambient	R _{UJA}	40	°C/W

Electrical Characteristics (T_A=25°C unless otherwise noted)

Part Number (Uni)	Part Number (Bi)	Breakdown Voltage V _{BR} @ I _T		Test Current I _T (mA)	Reverse Stand off Voltage V _R (Volts)	Maximum Reverse Leakage @ V _R I _R (µA)	Maximum Peak Pulse Current I _{PP} (A)	Maximum Clamping Voltage @ I _{PP} V _C (V)	Agency Approval 
		MIN	MAX						
SLD10U-017	SLD10-018	11.8	13	5.0	10	10	115	19.0	x
SLD16U-017	SLD16-018	18.0	22.0	1.0	16	10	76	28.6	x
SLD24U-017	SLD24-018	25.0	30.0	1.0	24	10	61	36.0	x

Notes:

- V_{BR} measured after I_T applied for 300µs, I_T = square wave pulse or equivalent.
- Surge current waveform per 100µs x 150ms exponential wave and derated per Fig. 3.
- All terms and symbols are consistent with ANSI/IEEE C62.35.

Description

The SLD Series is packaged in a highly reliable industry standard P600 axial leaded package and is designed to provide precision overvoltage protection for sensitive electronics.

Features

- Halogen-Free
- RoHS compliant
- Typical maximum temperature coefficient
 $\Delta V_{BR} = 0.1\% \times V_{BR} @ 25^\circ\text{C} \times \Delta T$
- Glass passivated chip junction in P600 package
- ISO 7637-2 Level 4 Impulse 5a; 2200W peak pulse capability at 100µs x 150ms waveform, repetition rate (duty cycles): 0.01%
- Fast response time: typically less than 1.0ps from 0 Volts to BV min
- Excellent clamping capability
- Low incremental surge resistance
- High temperature soldering guaranteed: 260°C/40 seconds / 0.375"(9.5mm) lead length, 5 lbs., (2.3kg) tension
- Plastic package has Underwriters Laboratory Flammability classification 94V-O
- Matte Tin Lead-free plated

Applications

Designed to protect sensitive electronics from:

- Inductive Load Switching
- Alternator Load Dump

Ratings and Characteristic Curves ($T_A=25^\circ\text{C}$ unless otherwise noted)

Figure 1 - Peak Pulse Power Rating Curve

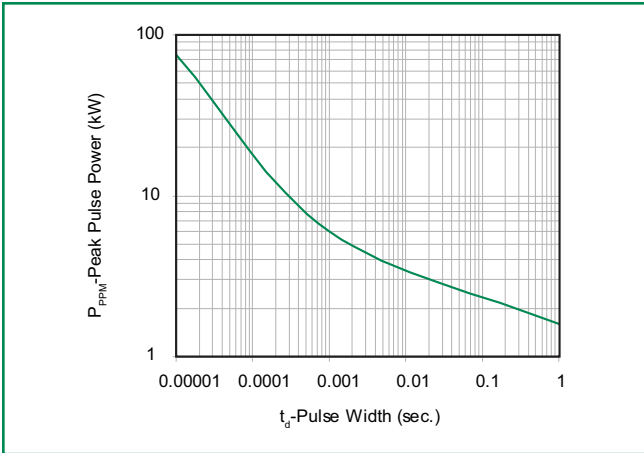

Figure 2 - Pulse Derating Curve

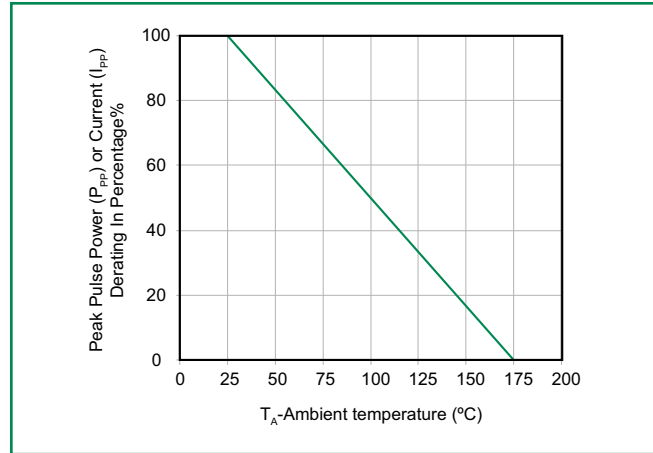

Figure 3 - Pulse Waveform

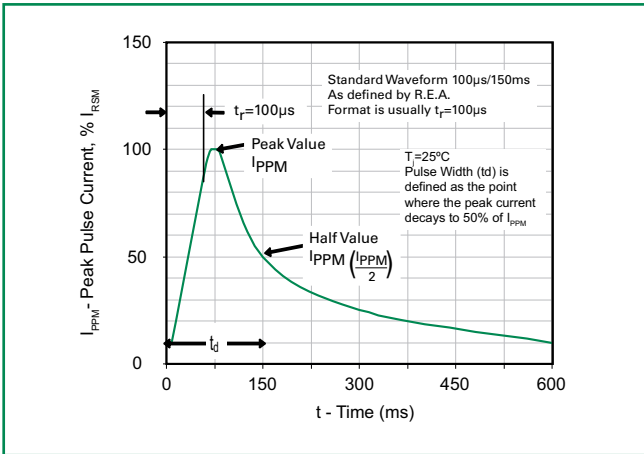

Figure 4 - Typical Junction Capacitance

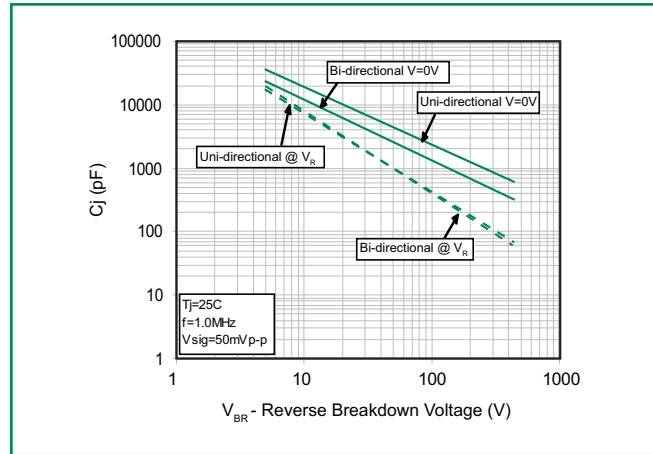

Figure 5 - Steady State Power Derating Curve

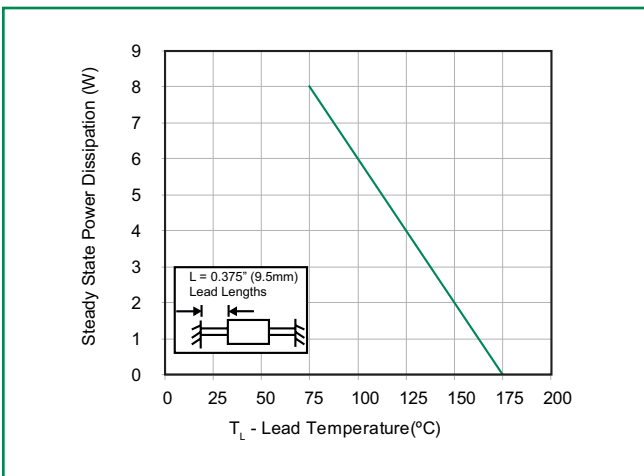
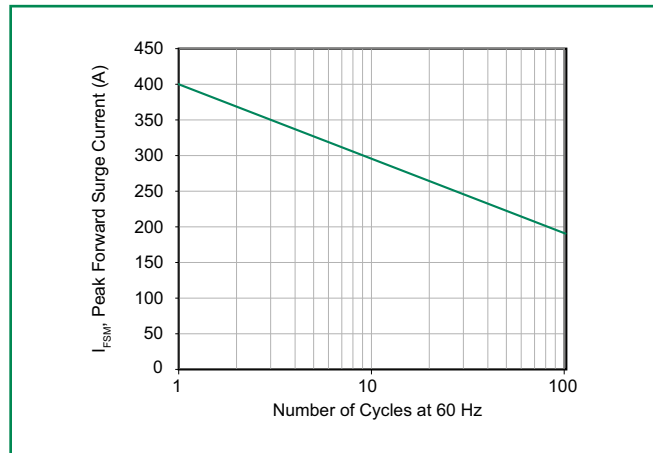
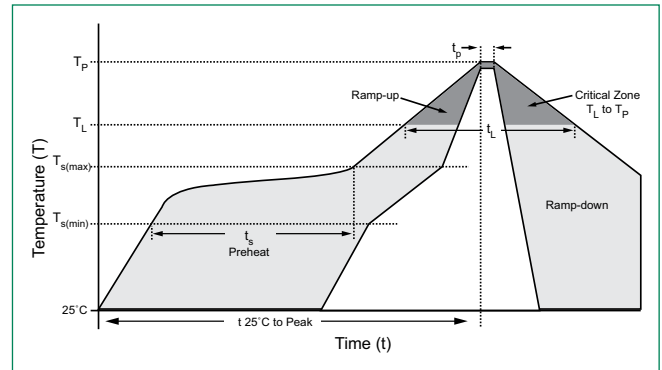

Figure 6 - Maximum Non-Repetitive Peak Forward Surge Current



Soldering Parameters

Reflow Condition		Lead-free assembly
Pre Heat	- Temperature Min ($T_{s(min)}$)	150°C
	- Temperature Max ($T_{s(max)}$)	200°C
	- Time (min to max) (t_s)	60 – 180 secs
Average ramp up rate (Liquidus Temp (T_L) to peak)		3°C/second max
$T_{s(max)}$ to T_L - Ramp-up Rate		3°C/second max
Reflow	- Temperature (T_L) (Liquidus)	217°C
	- Time (min to max) (t_s)	60 – 150 seconds
Peak Temperature (T_p)		260 ^{+0/-5} °C
Time within 5°C of actual peak Temperature (t_p)		20 – 40 seconds
Ramp-down Rate		6°C/second max
Time 25°C to peak Temperature (T_p)		8 minutes Max.
Do not exceed		280°C



Flow/Wave Soldering (Solder Dipping)

Peak Temperature :	265°C
Dipping Time :	10 seconds
Soldering :	1 time

Physical Specifications

Weight	0.07oz., 2.1g
Case	P600 molded plastic body over passivated junction.
Polarity	Color band denotes the cathode except Bipolar.
Terminal	Matte Tin axial leads, solderable per JESD22-B102D.

Environmental Specifications

Temperature Cycle	JESD22-A104
Pressure Cooker	JESD 22-A102
High Temp. Storage	JESD22-A103
HTRB	JESD22-A108
Thermal Shock	JESD22-A106

Dimensions

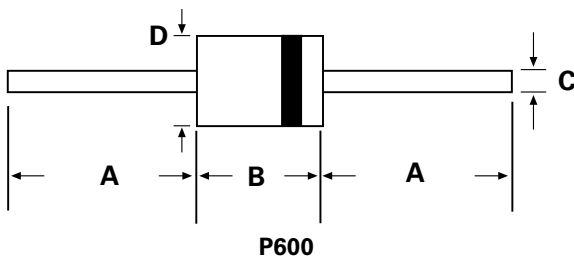

Dimensions	Inches		Millimeters	
	Min	Max	Min	Max
A	1.000	-	25.40	-
B	0.340	0.360	8.60	9.10
C	0.048	0.052	1.22	1.32
D	0.340	0.360	8.60	9.10

SLD Series

Part Numbering System

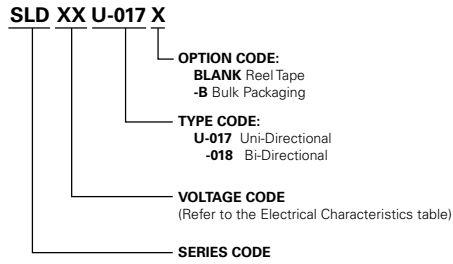

Part Marking System

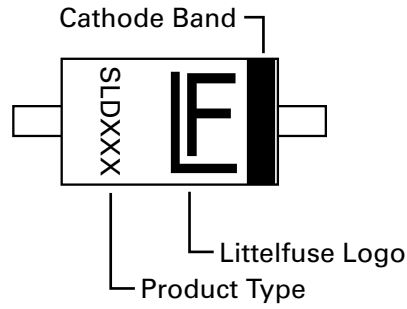

Packaging

Part Number	Component Package	Quantity	Packaging Option	Packaging Specification
SLDxxXXX	P600	800	Tape & Reel	EIA STD RS-296E
SLDxxXX-B	P600	500	BOX	Littelfuse Concord Packing Spec. DM-0016