



TO-220



ITO-220



TO-251 (IPAK)



TO-252 (DPAK)



Pin Definition:

1. Gate
2. Drain
3. Source

### PRODUCT SUMMARY

$V_{DS}$ (V)	$R_{DS(on)}$ ( $\Omega$ )	$I_D$ (A)
600	2.5 @ $V_{GS}=10V$	2

### General Description

The TSM4N60 is produced using advanced planar stripe, DMOS technology. This latest technology has been especially designed to minimize on-state resistance, have a high rugged avalanche characteristics. These devices are well suited for high efficiency switch mode power supplies, active power factor correction, electronic lamp ballasts base on half bridge topology.

### Features

- Robust high voltage termination
- Avalanche energy specified
- Diode is characterized for use in bridge circuits
- Source to Drain diode recovery time comparable to a discrete fast recovery diode.

### Ordering Information

Part No.	Package	Packing
TSM4N60CZ C0	TO-220	50pcs / Tube
TSM4N60CI C0	ITO-220	50pcs / Tube
TSM4N60CH C5	TO-251	80pcs / Tube
TSM4N60CP RO	TO-252	2.5Kpcs / 13" Reel

### Block Diagram

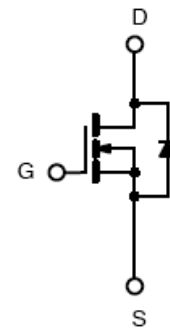

N-Channel MOSFET

### Absolute Maximum Rating ( $T_a = 25^\circ C$ unless otherwise noted)

Parameter	Symbol	Limit	Unit
Drain-Source Voltage	$V_{DS}$	600	V
Gate-Source Voltage	$V_{GS}$	$\pm 30$	V
Continuous Drain Current	$I_D$	4	A
Pulsed Drain Current	$I_{DM}$	16	A
Single Pulse Drain to Source Avalanche Energy ( $V_{DD} = 50V$ , $I_{AS}=4A$ , $L=27.5mH$ , $R_G=25\Omega$ ), Starting $T_J = 25^\circ C$	EAS	240	mJ
Repetitive Avalanche Energy (Pulse width limited by junction temperature)	EAR	10	mJ
Peak Diode Recovery dv/dt ( $I_{SD} \leq 4A$ , $di/dt \leq 200A/us$ , $V_{DD} \leq B_{VDSS}$ ) Starting $T_J=25^\circ C$	dv/dt	4.5	V/ns
Maximum Power Dissipation @ $T_a = 25^\circ C$	TO-220 / TO-251 / TO-252	70	W
	ITO-220	25	
Operating Junction Temperature	$T_J$	+150	$^\circ C$
Operating Junction and Storage Temperature Range	$T_J, T_{STG}$	-55 to +150	$^\circ C$

### Thermal Performance

Parameter	Symbol	Limit	Unit	
Thermal Resistance Junction to Case	$R_{\theta JC}$	TO-220 / TO-251 / TO-252	1.78	$^{\circ}C/W$
		ITO-220	5	
Thermal Resistance Junction to Ambient	$R_{\theta JA}$	TO-220 / ITO-220	62.5	$^{\circ}C/W$
		TO-251 / TO-252	100	

Notes: Surface mounted on FR4 board  $t \leq 10\text{sec}$

### Electrical Specifications ( $T_a=25^{\circ}C$ , unless otherwise noted)

Parameter	Conditions	Symbol	Min	Typ	Max	Unit
<b>Off Characteristics</b>						
Drain-Source Breakdown Voltage	$V_{GS} = 0V, I_D = 250\mu A$	$BV_{DSS}$	600	--	--	V
Breakdown Voltage Temperature Coefficient	$I_D = 250\mu A$ Referenced to $25^{\circ}C$	$\Delta BV_{DSS} / T_J$	--	0.6	--	$V/^{\circ}C$
Zero Gate Voltage Drain Current	$V_{DS} = 600V, V_{GS} = 0V$	$I_{DSS}$	--	--	10	$\mu A$
Gate Body Leakage	$V_{GS} = \pm 30V, V_{DS} = 0V$	$I_{GSS}$	--	--	$\pm 100$	nA
<b>On Characteristics</b>						
Gate Threshold Voltage	$V_{DS} = V_{GS}, I_D = 250\mu A$	$V_{GS(TH)}$	2.0	--	4.0	V
Drain-Source On-State Resistance	$V_{GS} = 10V, I_D = 2A$	$R_{DS(ON)}$	--	2	2.5	$\Omega$
<b>Dynamic Characteristics</b>						
Total Gate Charge	$V_{DS} = 480V, I_D = 4A,$ $V_{GS} = 10V$	$Q_g$	--	15	20	nC
Gate-Source Charge		$Q_{gs}$	--	2.8	--	
Gate-Drain Charge		$Q_{gd}$	--	6.2	--	
Input Capacitance	$V_{DS} = 25V, V_{GS} = 0V,$ $f = 1.0\text{MHz}$	$C_{iss}$	--	545	710	pF
Output Capacitance		$C_{oss}$	--	60	80	
Reverse Transfer Capacitance		$C_{rss}$	--	8	11	
Turn-On Delay Time	$V_{GS} = 10V, I_D = 4A,$ $V_{DD} = 300V, R_G = 25\Omega$	$t_{d(on)}$	--	10	30	nS
Turn-On Rise Time		$t_r$	--	35	80	
Turn-Off Delay Time		$t_{d(off)}$	--	45	100	
Turn-Off Fall Time		$t_f$	--	40	90	

### Source-Drain Diode Ratings and Characteristics

Continuous Source Current	Integral Reverse p-n Junction Diode in the MOSFET	$I_S$	--	--	4	A
Pulse Source Current		$I_{SM}$	--	--	16	
Diode Forward Voltage	$I_S = 4A, V_{GS} = 0V$	$V_{SD}$	--	--	1.4	V
Reverse Recovery Time	$I_S = 4A, V_{GS} = 0V$	$t_{rr}$	--	300	--	nS
Reverse Recovery Charge	$di/dt=100A/\mu s$	$Q_{rr}$	--	2.2	--	$\mu C$

Notes:

- Pulse test: pulse width  $\leq 300\mu s$ , duty cycle  $\leq 2\%$
- Essentially Independent of Operating Temperature.

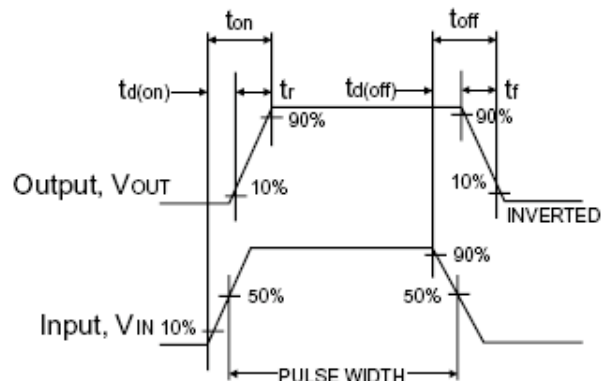
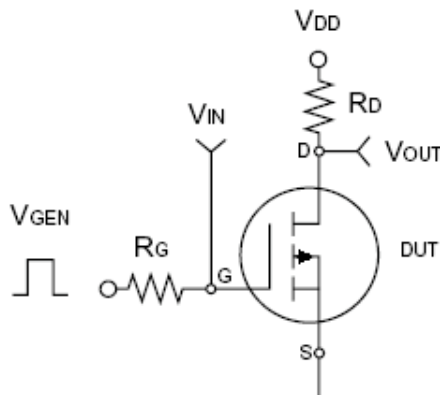

**Electrical Characteristics Curve** ( $T_a = 25^\circ\text{C}$ , unless otherwise noted)

**Output Characteristics**

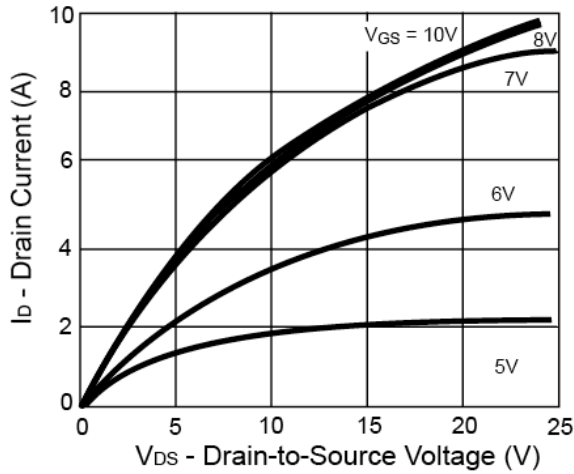

**Transfer Characteristics**

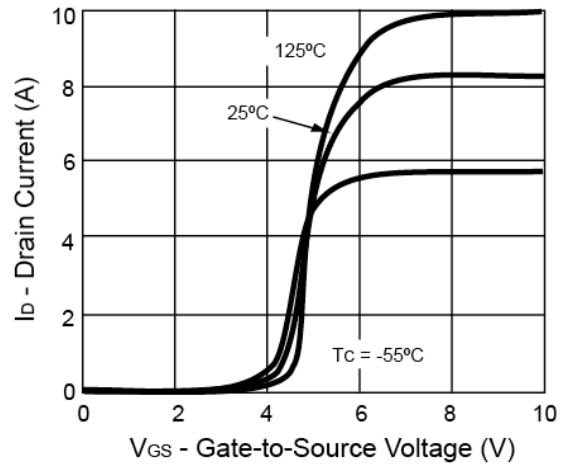

**On-Resistance vs. Drain Current**

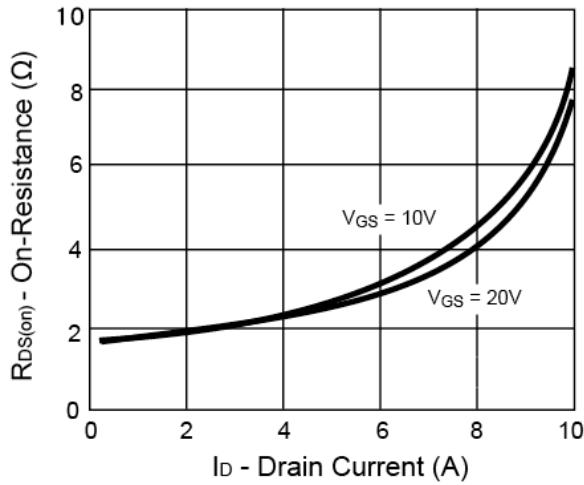

**Gate Charge**

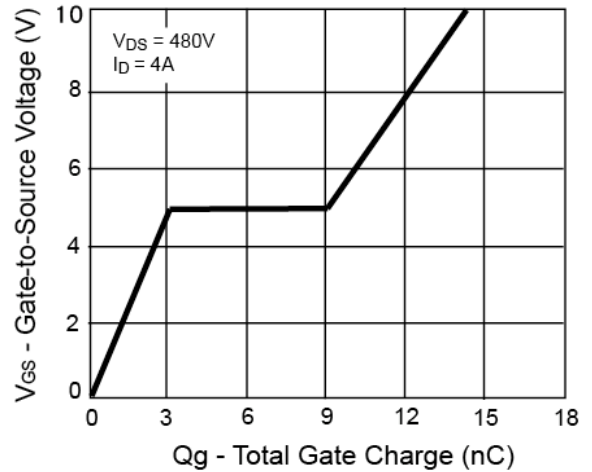

**On-Resistance vs. Junction Temperature**

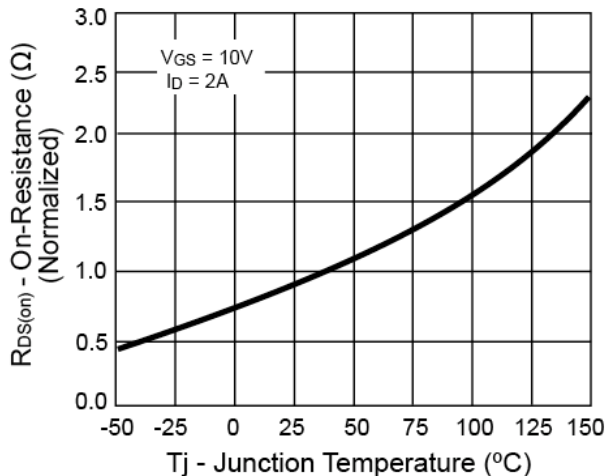

**Source-Drain Diode Forward Voltage**

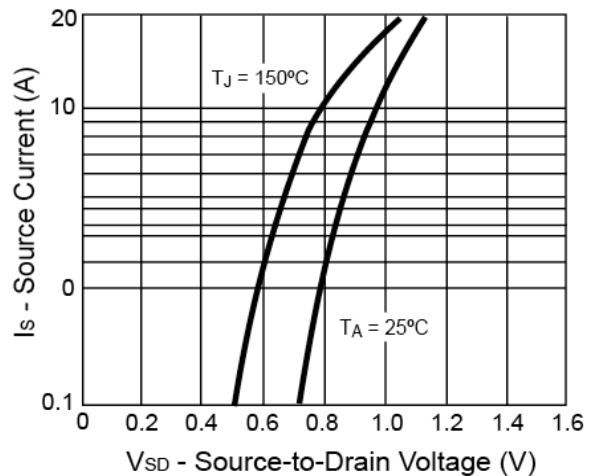

**Electrical Characteristics Curve** (Ta = 25°C, unless otherwise noted)

**Breakdown Voltage vs. Temperature**

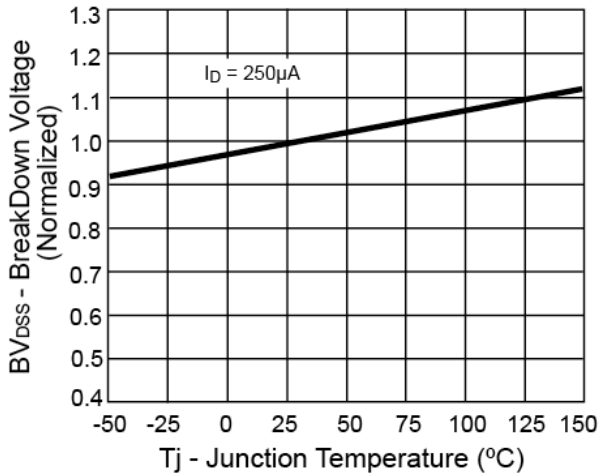

**Threshold Voltage vs. Temperature**

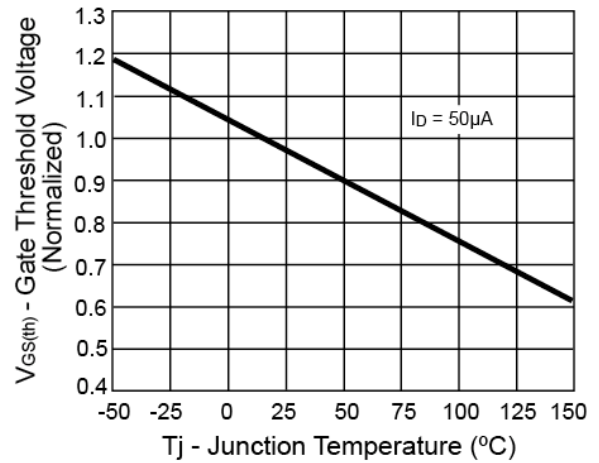

**Maximum Safe Operating Area**

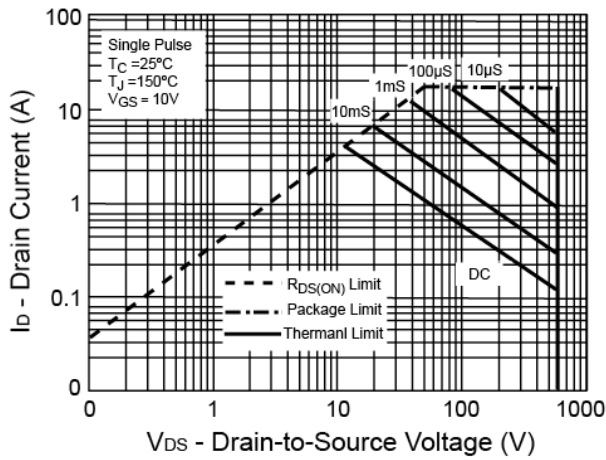

**Normalized Thermal Transient Impedance, Junction-to-Ambient**

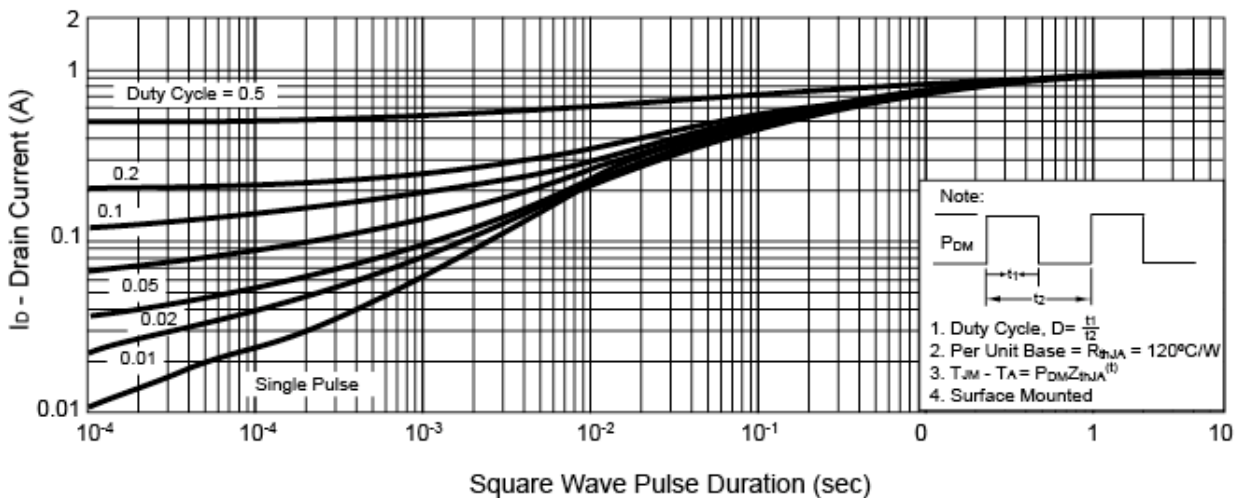

### TO-220 Mechanical Drawing

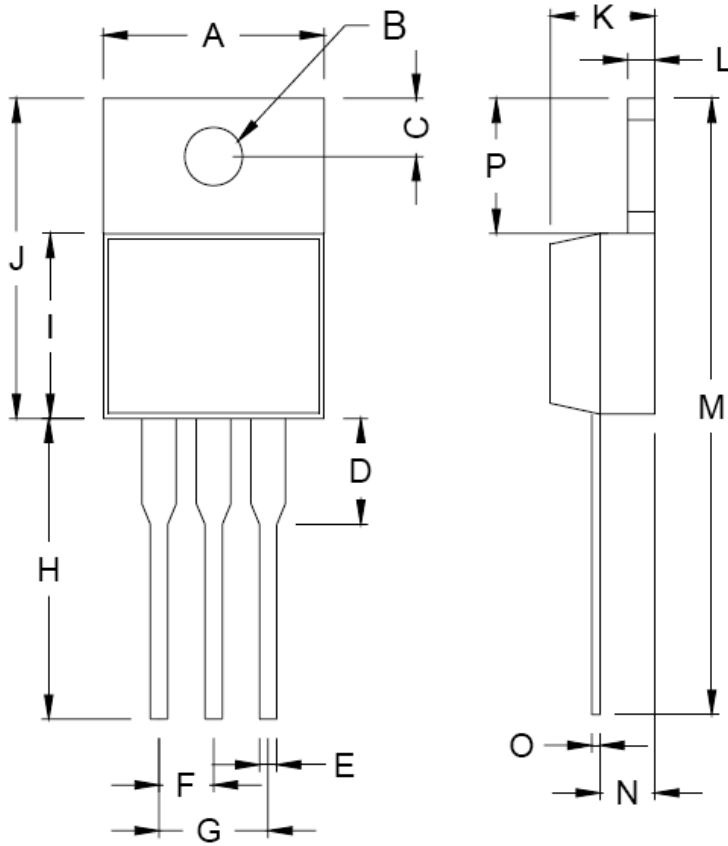

TO-220 DIMENSION				
DIM	MILLIMETERS		INCHES	
	MIN	MAX	MIN	MAX
A	10.000	10.500	0.394	0.413
B	3.740	3.910	0.147	0.154
C	2.440	2.940	0.096	0.116
D	-	6.350	-	0.250
E	0.381	1.106	0.015	0.040
F	2.345	2.715	0.092	0.058
G	4.690	5.430	0.092	0.107
H	12.700	14.732	0.500	0.581
I	8.382	9.017	0.330	0.355
J	14.224	16.510	0.560	0.650
K	3.556	4.826	0.140	0.190
L	0.508	1.397	0.020	0.055
M	27.700	29.620	1.060	1.230
N	2.032	2.921	0.080	0.115
O	0.255	0.610	0.010	0.024
P	5.842	6.858	0.230	0.270

### ITO-220 Mechanical Drawing

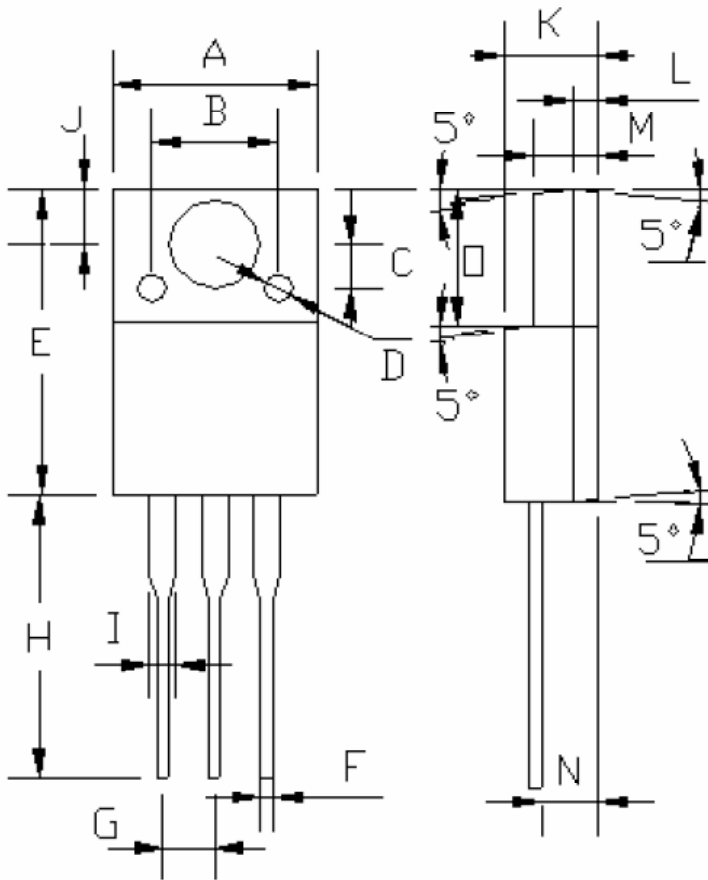

DIM	ITO-220 DIMENSION			
	MILLIMETERS		INCHES	
	MIN	MAX	MIN	MAX
A	10.04	10.07	0.395	0.396
B	6.20 (typ.)		0.244 (typ.)	
C	2.20 (typ.)		0.087 (typ.)	
D	∅ 1.40 (typ.)		∅ 0.055 (typ.)	
E	15.0	15.20	0.591	0.598
F	0.52	0.54	0.020	0.021
G	2.35	2.73	0.093	0.107
H	13.50	13.55	0.531	0.533
I	1.11	1.49	0.044	0.058
J	2.60	2.80	0.102	0.110
K	4.49	4.50	0.176	0.177
L	1.15 (typ.)		0.045 (typ.)	
M	3.03	3.05	0.119	0.120
N	2.60	2.80	0.102	0.110
O	6.55	6.65	0.258	0.262

**SOT-251 Mechanical Drawing**

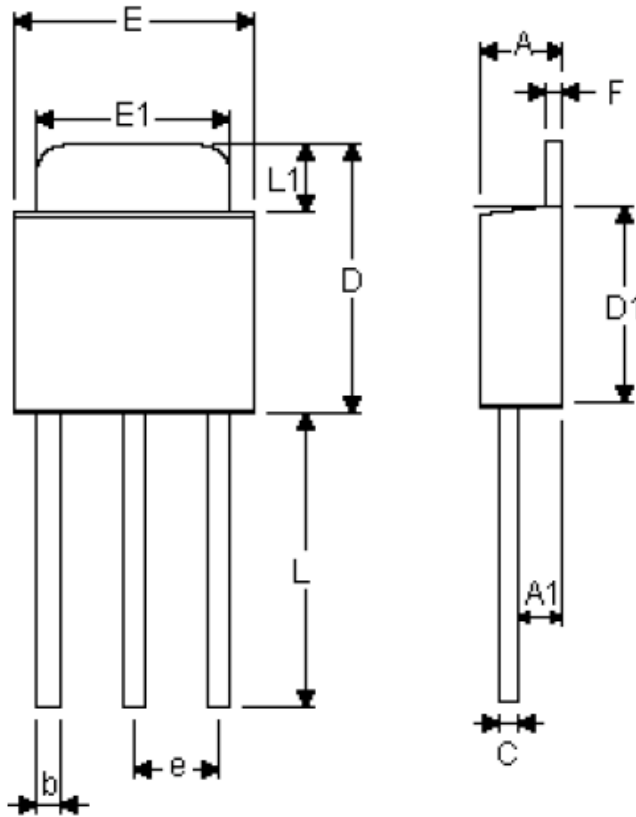

TO-251 DIMENSION				
DIM	MILLIMETERS		INCHES	
	MIN	MAX	MIN	MAX
A	2.20	2.4	0.087	0.095
A1	1.10	1.30	0.043	0.051
b	0.40	0.80	0.016	0.032
C	0.40	0.60	0.016	0.024
D	6.70	7.30	0.264	0.287
D1	5.40	5.65	0.213	0.222
E	6.40	6.65	0.252	0.262
e	2.10	2.50	0.083	0.098
F	0.40	0.60	0.016	0.024
L	7.00	8.00	0.276	0.315
L1	1.60	1.86	0.063	0.073

### SOT-252 Mechanical Drawing

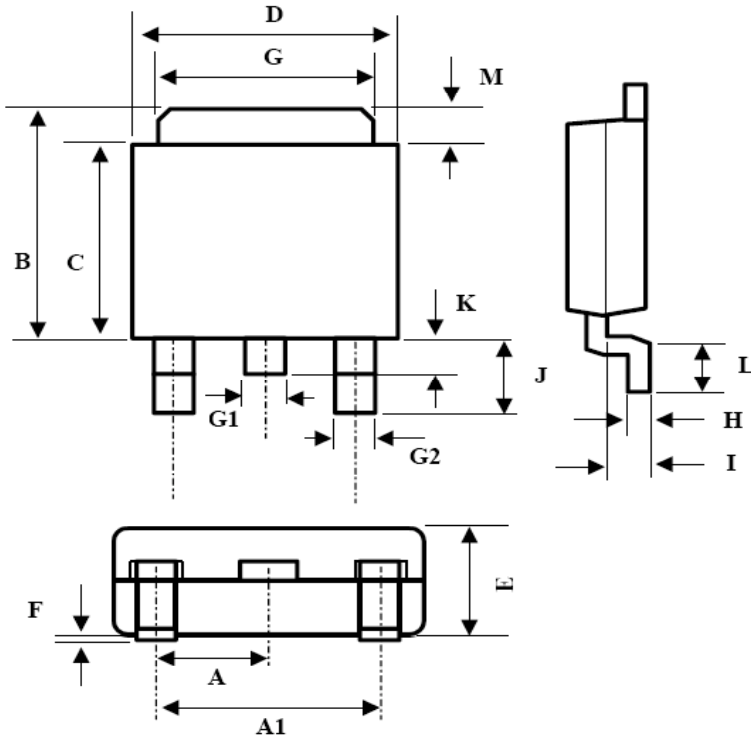

TO-252 DIMENSION				
DIM	MILLIMETERS		INCHES	
	MIN	MAX	MIN	MAX
A	2.3BSC		0.09BSC	
A1	4.6BSC		0.18BSC	
B	6.80	7.20	0.268	0.283
C	5.65	5.90	0.222	0.232
D	6.40	6.65	0.252	0.262
E	2.20	2.40	0.087	0.094
F	0.00	0.20	0.000	0.008
G	5.20	5.40	0.205	0.213
G1	0.75	0.85	0.030	0.033
G2	0.55	0.65	0.022	0.026
H	0.35	0.65	0.014	0.026
I	0.90	1.50	0.035	0.059
J	2.20	2.80	0.087	0.110
K	0.50	1.10	0.020	0.043
L	0.90	1.50	0.035	0.059
M	1.30	1.70	0.051	0.67



### Notice

Specifications of the products displayed herein are subject to change without notice. TSC or anyone on its behalf, assumes no responsibility or liability for any errors or inaccuracies.

Information contained herein is intended to provide a product description only. No license, express or implied, to any intellectual property rights is granted by this document. Except as provided in TSC's terms and conditions of sale for such products, TSC assumes no liability whatsoever, and disclaims any express or implied warranty, relating to sale and/or use of TSC products including liability or warranties relating to fitness for a particular purpose, merchantability, or infringement of any patent, copyright, or other intellectual property right.

The products shown herein are not designed for use in medical, life-saving, or life-sustaining applications. Customers using or selling these products for use in such applications do so at their own risk and agree to fully indemnify TSC for any damages resulting from such improper use or sale.