

MCS Series



- Microprocessor based soft-start / soft-stop controller
- Ratings from 25A to 90A @ 48-530 VAC
- Low-voltage, current, or potentiometer control
- Output status indicator
- Adjustable ramp rates

PRODUCT SELECTION

Line Voltage	25 A	50 A	90 A
120 Vrms	MCST1225	MCST1250	MCST1290
240 Vrms	MCST2425	MCST2450	MCST2490
480 Vrms	MCST4825	MCST4850	MCST4890

AVAILABLE OPTIONS

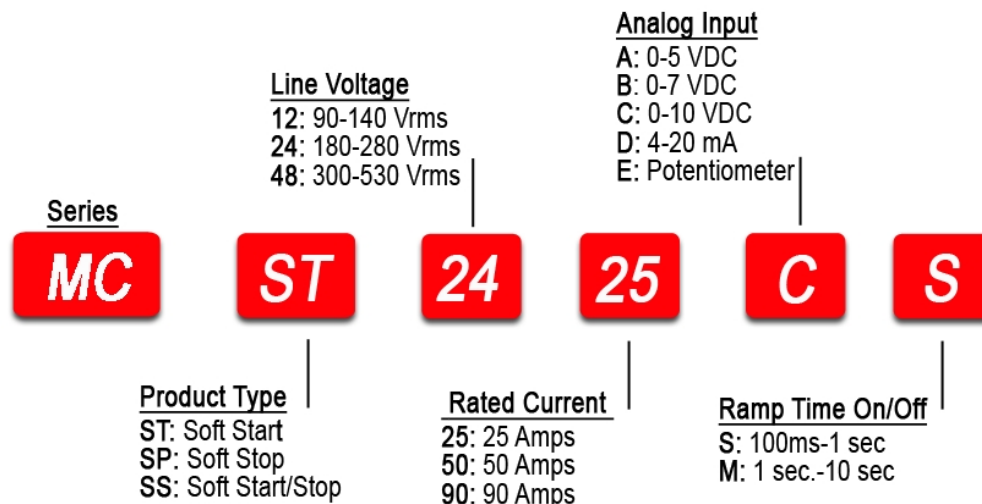

OUTPUT SPECIFICATIONS (voltage)

Description	120 VAC	240 VAC	480 VAC
Operating Voltage (47-63Hz) [Vrms]	48-140	180-280	300-530
Transient Overvoltage [Vpk]	400	600	1200
Maximum Off-State Leakage Current @ Rated Voltage [mArms]	5	7	12
Minimum Off-State dv/dt @ Maximum Rated Voltage [V/μsec]	200	200	200

OUTPUT SPECIFICATIONS (current)

Description	25 A	50 A	90 A
Maximum Load Current [Arms]	25	50	90
Minimum Load Current [mArms]	150	150	150
Maximum Surge Current (16.6ms) [Apk]	250	625	1200
Maximum On-State Voltage Drop @ Rated Current [Vpk]	1.6	1.6	1.6
Thermal Resistance Junction to Case (Rjc) [°C/W]	1.02	0.63	0.28
Maximum I ² t for Fusing (8.3 msec) [A ² sec]	260	1620	6000

INPUT SPECIFICATIONS (1)

Description	DC Control
Control Voltage Range (VDC)	8-32
Input Current Range [mA]	28-30
Nominal Input Impedance [Ohms]	30K
Control Must Operate Voltage "On" [VDC][P3]	5-32
Control Must Release Voltage "Off" [VDC][P3]	0-4
Input Current [mA][P3]	0-2.6
Analog Range Option A [VDC][P4]	0.5-5
Analog Range Option B [VDC][P4]	1.25-7
Analog Range Option C [VDC][P4]	2-10
Analog Range Option D [VDC][P4]	4-20
Nominal Input Impedance Option A,B,C[ohms][P4]	20K
Nominal Input Impedance Option D [ohms][P4]	220

GENERAL SPECIFICATIONS

Description	Parameters
Minimum Power Factor (with Maximum Load)	0.5
Dielectric Strength, Input/Output/Base (50/60Hz)	4000 Vrms
Minimum Insulation Resistance (@ 500 V DC)	10 ⁹ Ohm
Maximum Capacitance, Input/Output	10 pF
Ambient Operating Temperature Range	-20 to 80°C
Ambient Storage Temperature Range	-40 to 125 °C
Weight (typical)	3.0 oz (86.5g)
Encapsulation	Thermally conductive Epoxy
Terminals-Power	Screws and Saddle Clamps Furnished, Unmounted
Terminals-Control	Barrier Strip Screw Terminals
Recommended Terminal Screw Torque Range:	8-32 Screws -20 in. lbs.(Screws dry without grease) Input Connections via Screw Type Barrier Strip

GENERAL NOTES

1) Voltages are reference to GND (Ground = 0 VDC) P2

OUTPUT STATUS FUNCTIONS

Conditions	LED Status
Initial Logic Supply On	Flash Once
Load Voltage Missing / Load Open (w/control P3 disabled)	Flash Once Intermittently
Load Voltage Missing / Load Open (w/control P3 enabled)	Off
Ramp Time (Soft Start upon P3 Enabled)	Off to Bright
Ramp Time (Soft Start upon P3 Disabled)	Bright to Off
Output ON (Normally Steady Operation)	On

THERMAL DERATE INFORMATION

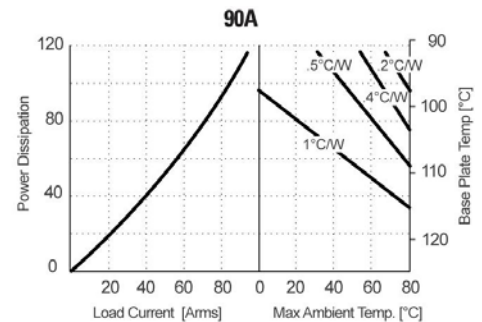
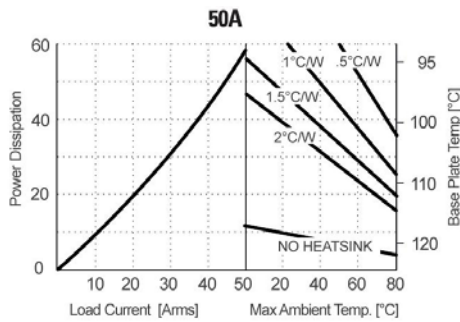
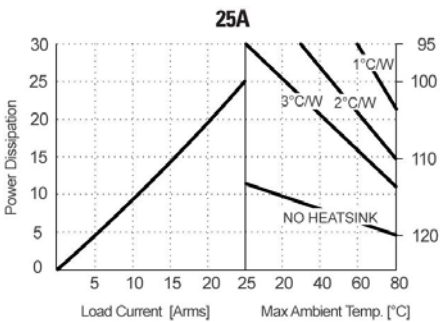

MECHANICAL SPECIFICATIONS

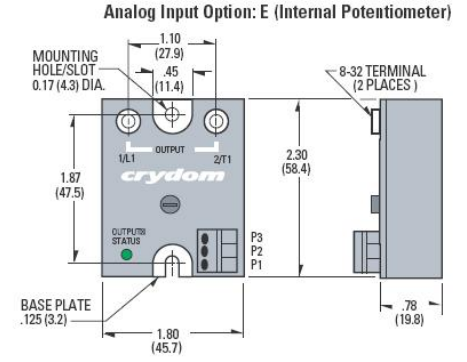
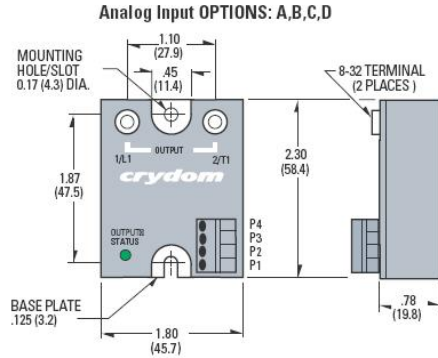
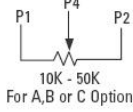
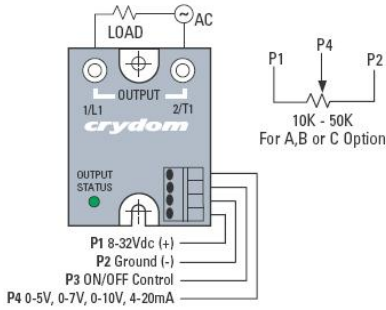

Dimensions are in inches (millimeters)

RAMP TIME IN SECONDS

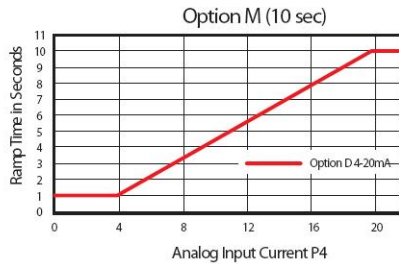
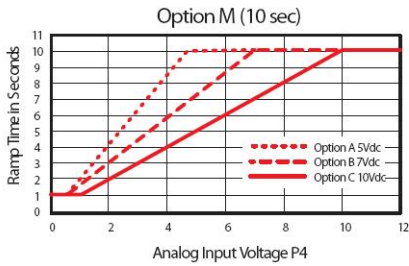
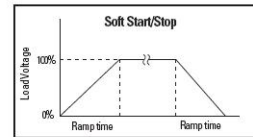
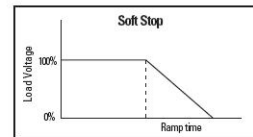
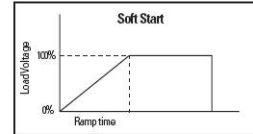
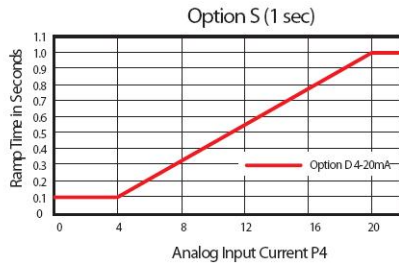
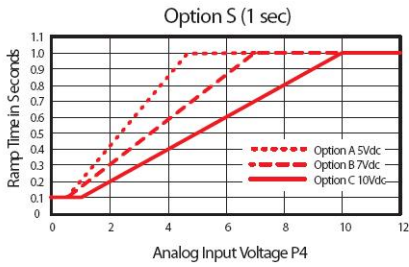

AGENCY APPROVALS

UL E11 6949



Rev. 082609

⚠ WARNING / AVERTISSEMENT / WARNUNG / ADVERTENCIA / AVVERTENZA / AVISO

<p>RISK OF MATERIAL DAMAGE AND HOT ENCLOSURE</p> <ul style="list-style-type: none"> • The product's side panels may be hot, allow time for product to cool before touching. • Follow proper mounting instructions including torque values. • Do not allow liquids or foreign objects to enter this product. <p>Failure to follow this instruction can result in serious injury, or equipment damage.</p>	<p>RISQUE DE DOMMAGE MATERIEL ET DE SURCHAUFFE DU BOITIER</p> <ul style="list-style-type: none"> • Les panneaux latéraux du produit peuvent être chauds. Laissez le produit refroidir avant de le toucher. • Respecter les consignes de montage, et notamment les couples de serrage. • Ne pas laisser pénétrer de liquide ni de corps étrangers à l'intérieur du produit. <p>Le non-respect de cette directive peut entraîner, des lésions corporelles graves ou des dommages matériels.</p>	<p>GEFAHR VON MATERIALSCHÄDEN UND GEHÄUSEERHITZUNG</p> <ul style="list-style-type: none"> • Die Seitenwände können heiß sein. Lassen Sie das Produkt abkühlen, bevor Sie es berühren. • Beachten Sie die Montageanweisungen, Führen Sie keine Flüssigkeiten oder Fremdkörper in das Produkt ein. <p>Die Nichtbeachtung dieser Anweisung kann Körperverletzung oder Materialschäden zur Folge haben.</p>
<p>RIESGO DE DAÑOS MATERIALES Y DE SOBRECALENTAMIENTO DE LA UNIDAD</p> <ul style="list-style-type: none"> • Los paneles laterales del producto pueden estar calientes. Esperar que el producto se enfríe antes de tocarlo. • Respetar las instrucciones de montaje, y en particular los pares de apretado. • No dejar que penetren líquidos o cuerpos extraños en el producto. <p>Si no se respetan estas precauciones pueden producirse graves lesiones, daños materiales.</p>	<p>RISCHIO DI DANNI MATERIALI E D'INVOLUCRO CALDO</p> <ul style="list-style-type: none"> • I pannelli laterali dell'apparecchio possono scottare; lasciar quindi raffreddare il prodotto prima di toccarlo. • Seguire le istruzioni di montaggio corrette. • Non far entrare liquidi o oggetti estranei in questo apparecchio. <p>La mancata osservanza di questa precauzione può causare gravi rischi per l'incolumità personale o danni alle apparecchiature.</p>	<p>RISCO DE DANO MATERIAL E DE AQUECIMENTO</p> <ul style="list-style-type: none"> • Os painéis laterais do produto podem estar quentes; dê tempo ao produto para arrefecer antes de lhe tocar. • Siga devidamente as instruções de montagem. • Não permita a entrada de líquidos e de objectos estranhos no produto. <p>A não observância destas precauções pode provocar a morte, ferimentos graves ou danos materiais.</p>

⚠ DANGER / PELIGRO / DANGER /GEFAHR / PERICOLO / PERIGO

<p>HAZARD OF ELECTRIC SHOCK, EXPLOSION, OR ARC FLASH.</p> <ul style="list-style-type: none"> • Disconnect all power before installing or working with this equipment. • Verify all connections and replace all covers before turning on power. <p>Failure to follow these instructions will result in death or serious injury.</p>	<p>RIESGO DE DESCARGA ELECTRICA O EXPLOSION.</p> <ul style="list-style-type: none"> • Desconectar todos los suministros de energia a este equipo antes de trabajar con este equipo. • Verificar todas las conexiones y colocar todas las tapas antes de energizar el equipo. <p>El incumplimiento de estas instrucciones puede provocar la muerte o lesiones serias.</p>	<p>RISQUE DE DESCARGE ELECTRIQUE OU EXPLOSION.</p> <ul style="list-style-type: none"> • Eteindre toutes les sources d'énergie de cet appareil avant de travailler dessus de cet appareil • Vérifier tous connections, et remettre tous couverts en olace avant de mettre sous <p>De non-suivi de ces instructions provoquera la mort ou des lésions sérieuses.</p>	<p>GEFAHR EINES ELEKTRISCHE N SCHLAGES ODER EINER EXPLOSION.</p> <ul style="list-style-type: none"> • Stellen Sie jeglichen Strom ab, der dieses Gerät versorgt, bevor Sie an dem Gerät Arbeiten durchführen • Vor der Inbetriebnahme alle Anschlüsse überprüfen und alle Gehäuseteile montieren. <p>Unterlassung dieser Anweisungen können zum Tode oder zu schweren Verletzungen führen.</p>	<p>RISCHIO DI SCOSSA ELETTRICA O DELL'ESPLOSIONE.</p> <ul style="list-style-type: none"> • Spenga tutta l'alimentazion e che fornisce questa apparecchiatura prima del lavorare a questa apparecchiatura • Verificare tutti i collegamenti e sostituire tutte le coperture prima della rotazione sull'alimentazione <p>L'omissione di seguire queste istruzioni provocherà la morte o di lesioni serie</p>	<p>RISCO DE DESCARGA ELÉTRICA OU EXPLOSÃO</p> <ul style="list-style-type: none"> • Desconectar o equipamento de toda a energia antes de instalar ou trabalhar com este equipamento • Verificar todas as conexões e recolocar todas as tampas antes de religar o equipamento <p>O não cumprimento destas instruções pode levar á morte ou lesões sérias.</p>
---	---	---	---	---	--

ANNEX - ENVIROMENTAL INFORMATION

The environmental information disclosed in this annex including the EIP Pollution logo are in compliance with People's Republic of China Electronic Industry Standard SJ/T11364 – 2006, Marking for Control of Pollution Caused by Electronic Information Products.

Part Name	Toxic or hazardous Substance and Elements					
	Lead (Pb)	Mercury (Hg)	Cadmium (Cd)	Hexavalent Chromium (Cr (VI))	Polybrominated biphenyls (PBB)	Polybrominated diphenyl ethers (PBDE)
Semiconductor die	X	0	0	0	0	0
Solder	X	0	0	0	0	0

此附件所标示的包括电子信息产品污染图标的环境信息符合中华人民共和国电子行业标准 **SJ/T11364 - 2006**, 电子信息产品污染控制标识要求



部件名称	有毒有害物质或元素					
	铅 (Pb)	汞 (Hg)	镉 (Cd)	六价铬 (Cr (VI))	多溴联苯 (PBB)	多溴二苯醚 (PBDE)
半导体芯片	X	0	0	0	0	0
焊接点	X	0	0	0	0	0