



# MICROCHIP MCP1631/HV/MCP1631V/VHV

## High-Speed, Pulse Width Modulator

### Features

- Programmable Switching Battery Charger Designs
- High-Speed Analog PWM Controller (2 MHz Operation)
- Combine with Microcontroller for “Intelligent” Power System Development
- Peak Current Mode Control (MCP1631)
- Voltage Mode Control (MCP1631V)
- High Voltage Options Operate to +16V Input:
  - MCP1631HV Current Mode
  - MCP1631VHV Voltage Mode
- Regulated Output Voltage Options:
  - +5.0V or +3.3V
  - 250 mA maximum current
- External Oscillator Input sets Switching Frequency and Maximum Duty Cycle Limit
- External Reference Input Sets Regulation Voltage or Current
- Error Amplifier, Battery Current  $I_{SNS}$  Amplifier, Battery Voltage  $V_{SNS}$  Amplifier Integrated
- Integrated Overvoltage Comparator
- Integrated High Current Low Side MOSFET Driver (1A Peak)
- Shutdown mode reduces IQ to 2.4  $\mu$ A (typical)
- Internal Overtemperature Protection
- Undervoltage Lockout (UVLO)
- Package Options:
  - 4 mm x 4 mm 20-Lead QFN (MCP1631/MCP1631V only)
  - 20-Lead TSSOP (All Devices)
  - 20-Lead SSOP (All Devices)

### Applications

- High Input Voltage Programmable Switching Battery Chargers
- Supports Multiple Chemistries Li-Ion, NiMH, NiCd Intelligent and Pb-Acid
- LED Lighting Applications
- Constant Current SEPIC Power Train Design
- USB Input Programmable Switching Battery Chargers

### General Description

The MCP1631/MCP1631V is a high-speed analog pulse width modulator (PWM) used to develop intelligent power systems. When combined with a microcontroller, the MCP1631/MCP1631V will control the power system duty cycle providing output voltage or current regulation. The microcontroller can be used to adjust output voltage or current, switching frequency and maximum duty cycle while providing additional features making the power system more intelligent, robust and adaptable.

Typical applications for the MCP1631/MCP1631V include programmable switch mode battery chargers capable of charging multiple chemistries, like Li-Ion, NiMH, NiCd and Pb-Acid configured as single or multiple cells. By combining with a small microcontroller, intelligent LED lighting designs and programmable SEPIC topology voltage and current sources can also be developed.

The MCP1631/MCP1631V inputs were developed to be attached to the I/O pins of a microcontroller for design flexibility. Additional features integrated into the MCP1631HV/MCP1631VHV provide signal conditioning and protection features for battery charger or constant current source applications.

For applications that operate from a high voltage input, the MCP1631HV and MCP1631VHV device options can be used to operate directly from a +3.5V to +16V input. For these applications, an additional low drop out +5V or +3.3V regulated output is available and can provide current up to 250 mA to power a microcontroller and auxiliary circuits.

# MCP1631/HV/MCP1631V/VHV

## Package Types

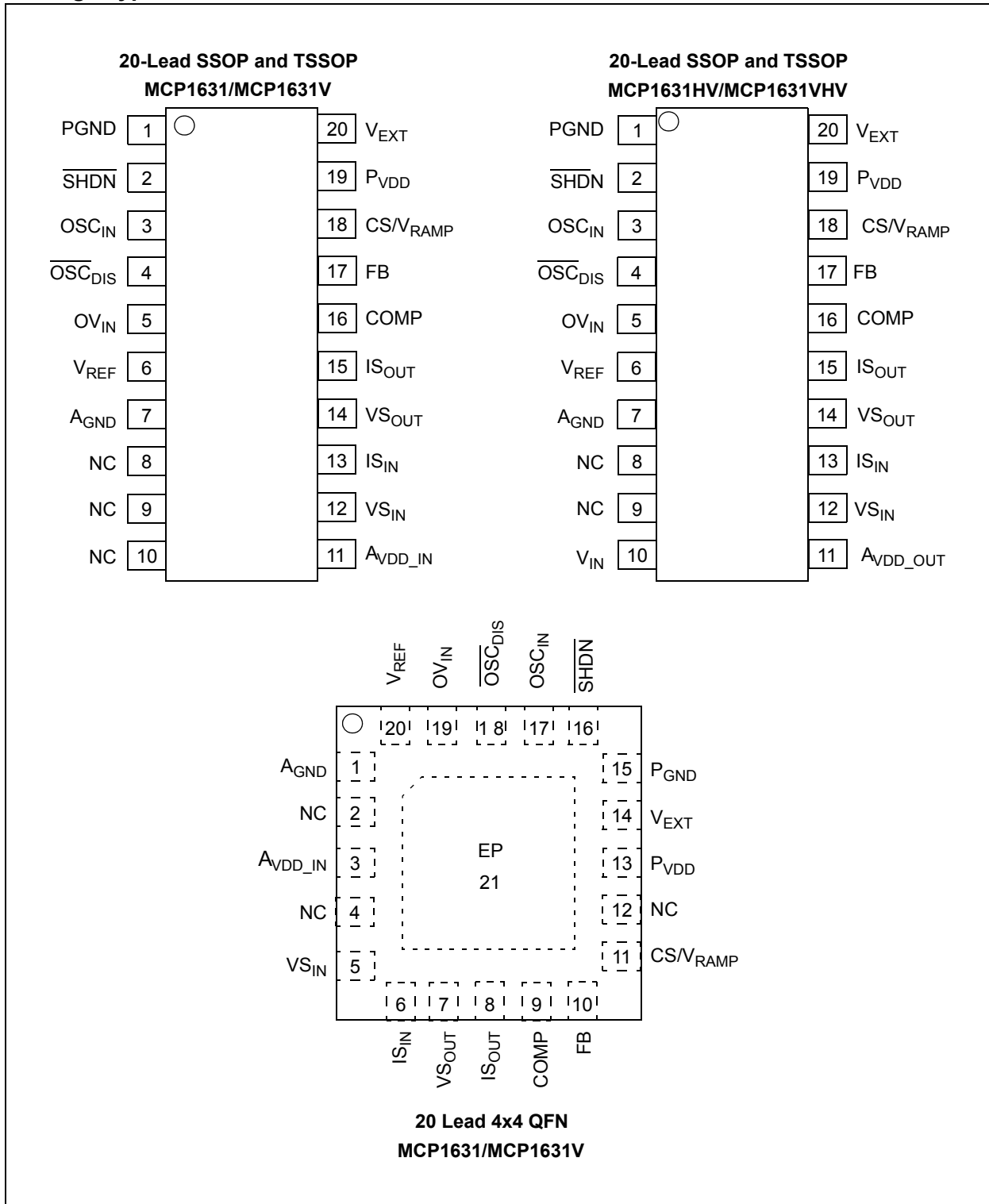

# MCP1631/HV/MCP1631V/VHV

## Typical Application Diagram

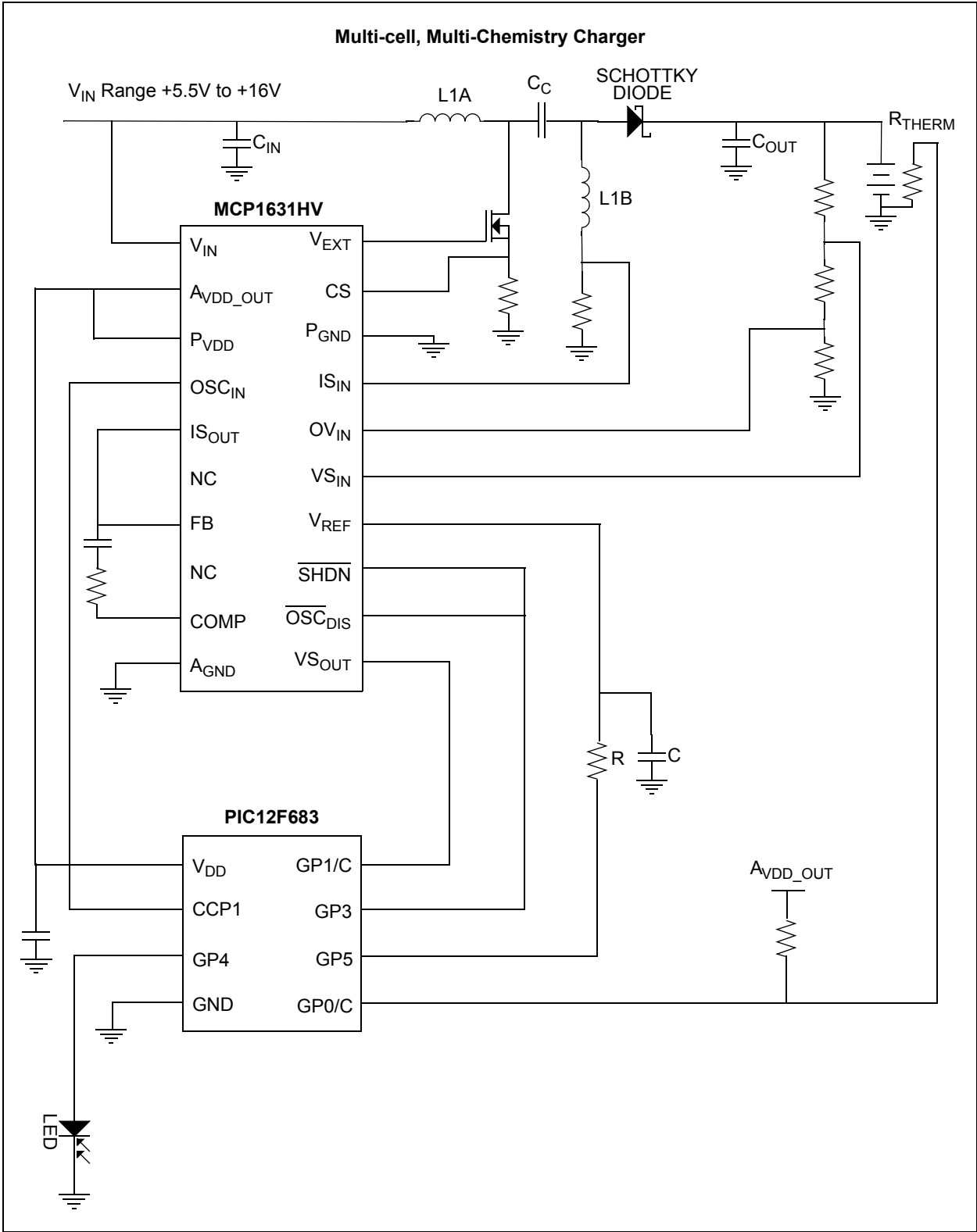

# MCP1631/HV/MCP1631V/VHV

## Functional Block Diagram<sup>(1)</sup>

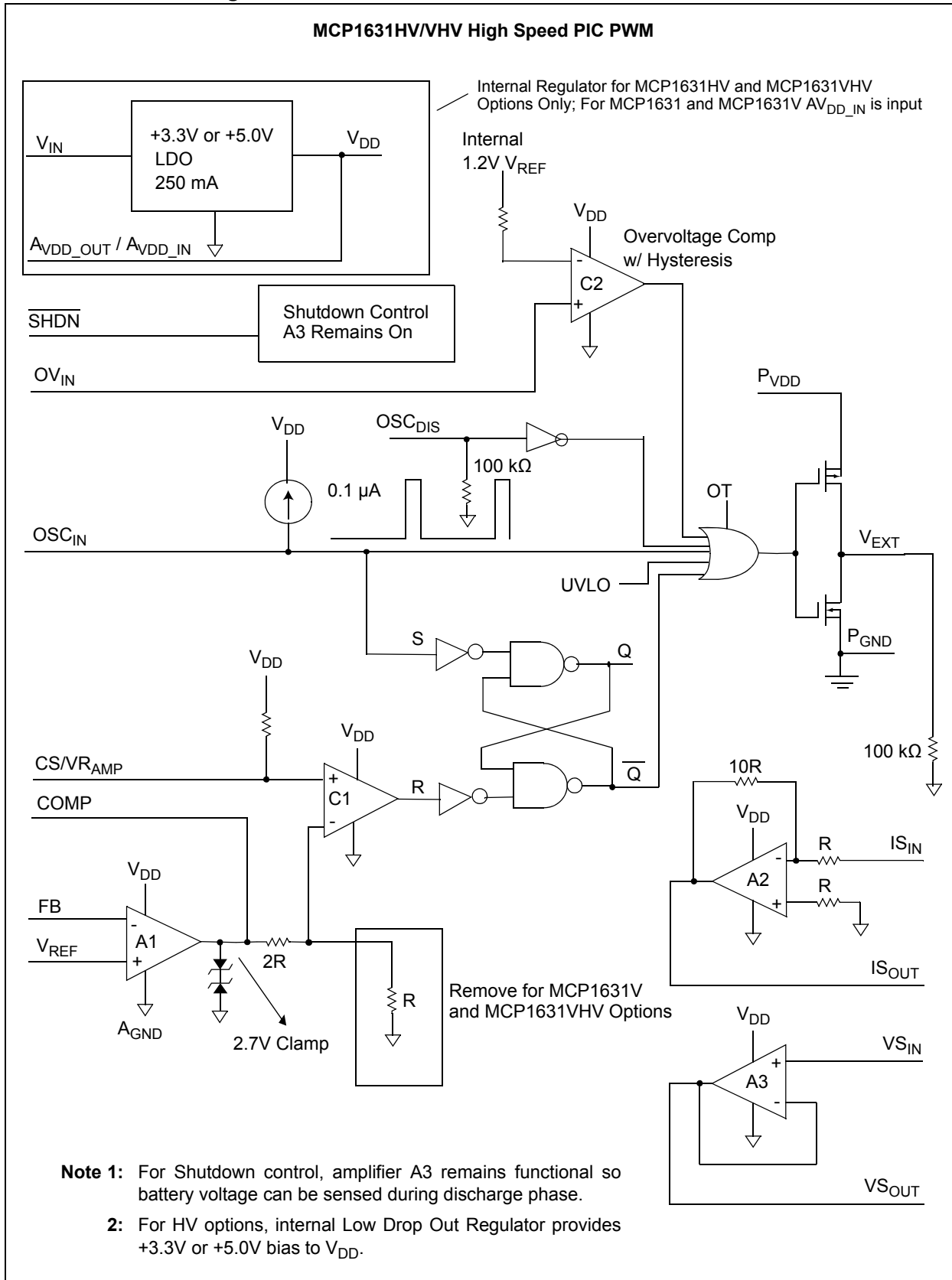

# MCP1631/HV/MCP1631V/VHV

## 1.0 ELECTRICAL CHARACTERISTICS

### Absolute Maximum Ratings †

V <sub>IN</sub> - GND (MCP1631/V).....	+6.5V
V <sub>IN</sub> - GND (MCP1631HV/VHV).....	+18.0V
All Other I/O .....	(GND - 0.3V) to (V <sub>DD</sub> + 0.3V)
LX to GND.....	-0.3V to (V <sub>DD</sub> + 0.3V)
V <sub>EXT</sub> Output Short Circuit Current .....	Continuous
Storage temperature .....	-65°C to +150°C
Maximum Junction Temperature.....	-40°C to +150°C
Operating Junction Temperature.....	-40°C to +125°C
ESD Protection On All Pins:	
HBM .....	4 kV
MM .....	400V

† **Notice:** Stresses above those listed under "Maximum Ratings" may cause permanent damage to the device. This is a stress rating only and functional operation of the device at those or any other conditions above those indicated in the operational sections of this specification is not intended. Exposure to maximum rating conditions for extended periods may affect device reliability.

### DC CHARACTERISTICS

**Electrical Specifications:** Unless otherwise noted, V<sub>IN</sub> = 3.0V to 5.5V, F<sub>OSC</sub> = 1 MHz with 10% Duty Cycle, C<sub>IN</sub> = 0.1 μF, V<sub>DD</sub> for typical values = 5.0V, T<sub>A</sub> for typical values = +25°C, T<sub>A</sub> = -40°C to +125°C for all minimum and maximums.

Parameters	Sym	Min	Typ	Max	Units	Conditions
<b>Input Characteristics</b>						
Input Voltage (MCP1631/V)	V <sub>DD</sub>	3.0	—	5.5	V	Non-HV Options
Input Voltage (MCP1631HV/VHV)	V <sub>DD</sub>	3.5	—	16.0	V	HV Options ( <b>Note 2</b> )
Undervoltage Lockout (MCP1631/V)	UVLO	2.7	2.8	3.0	V	V <sub>IN</sub> Falling, V <sub>EXT</sub> low when input below UVLO threshold
Undervoltage Lockout Hysteresis (MCP1631/MCP1631V)	UVLO_HYS	40	64	100	mV	UVLO Hysteresis
Input Quiescent Current (MCP1631/V, MCP1631HV,VHV)	I(V <sub>IN</sub> )	—	3.7	5	mA	SHDN = V <sub>DD</sub> = OSC <sub>DIS</sub>
Shutdown Current I <sub>AVDD</sub> for MCP1631/V I <sub>VIN</sub> for MCP1631HV/VHV	I <sub>IN_SHDN</sub>	—	2.4 4.4	12 17	μA μA	SHDN = GND = OSC <sub>DIS</sub> , <b>Note:</b> Amplifier A3 remains powered during Shutdown.
<b>OSC<sub>IN</sub>, OSC<sub>DIS</sub> and SHDN Input Levels</b>						
Low Level Input Voltage	V <sub>IL</sub>	—	—	0.8	V	
High Level Input Voltage	V <sub>IH</sub>	2.0	—	—	V	
Input Leakage Current	I <sub>LEAK</sub>	—	0.005	1	μA	
External Oscillator Range	F <sub>OSC</sub>	—	—	2	MHz	Maximum operating frequency is dependent upon circuit topology and duty cycle.
Minimum Oscillator High Time Minimum Oscillator Low Time	T <sub>OH_MIN</sub> . T <sub>OL_MIN</sub> .	—	10	—	ns	
Oscillator Rise and Fall Time	T <sub>R</sub> and T <sub>F</sub>	0.01	—	10	μs	<b>Note 1</b>
Oscillator Input Capacitance	C <sub>OSC</sub>	—	5	—	pf	

- Note 1:** External Oscillator Input (OSC<sub>IN</sub>) rise and fall times between 10 ns and 10 μs were determined during device characterization testing. Signal levels between 0.8V and 2.0V with rise and fall times measured between 10% and 90% of maximum and minimum values. Not production tested. Additional timing specifications were fully characterized and specified that are not production tested.
- 2:** The minimum V<sub>IN</sub> must meet two conditions: V<sub>IN</sub> ≥ 3.5V and V<sub>IN</sub> ≥ (V<sub>OUT(MAX)</sub> + V<sub>DROPOUT(MAX)</sub>).
- 3:** TCV<sub>OUT</sub> = (V<sub>OUT-HIGH</sub> - V<sub>OUT-LOW</sub>) \* 10<sup>6</sup> / (V<sub>R</sub> \* ΔTemperature), V<sub>OUT-HIGH</sub> = highest voltage measured over the temperature range. V<sub>OUT-LOW</sub> = lowest voltage measured over the temperature range.
- 4:** Load regulation is measured at a constant junction temperature using low duty cycle pulse testing. Changes in output voltage due to heating effects are determined using thermal regulation specification TCV<sub>OUT</sub>.
- 5:** Dropout voltage is defined as the input to output differential at which the output voltage drops 2% below its measured value with an applied input voltage of V<sub>OUT(MAX)</sub> + V<sub>DROPOUT(MAX)</sub> or 3.5V, whichever is greater.

# MCP1631/HV/MCP1631V/VHV

## DC CHARACTERISTICS (CONTINUED)

<b>Electrical Specifications:</b> Unless otherwise noted, $V_{IN} = 3.0V$ to $5.5V$ , $F_{OSC} = 1$ MHz with 10% Duty Cycle, $C_{IN} = 0.1$ $\mu F$ , $V_{DD}$ for typical values = $5.0V$ , $T_A$ for typical values = $+25^{\circ}C$ , $T_A = -40^{\circ}C$ to $+125^{\circ}C$ for all minimum and maximums.						
Parameters	Sym	Min	Typ	Max	Units	Conditions
<b>External Reference Input</b>						
Reference Voltage Input	$V_{REF}$	0	—	$AV_{DD}$	V	The reference input is capable of rail-to-rail operation.
<b>Internal Driver)</b>						
$R_{DSON}$ P-channel	$R_{DSON\_P}$	—	7.2	15	$\Omega$	
$R_{DSON}$ N-channel	$R_{DSON\_N}$	—	3.8	15	$\Omega$	
$V_{EXT}$ Rise Time	$T_{RISE}$	—	2.5	18	ns	$C_L = 100$ pF Typical for $V_{IN} = 5V$ ( <b>Note 1</b> )
$V_{EXT}$ Fall Time	$T_{FALL}$	—	2.7	18	ns	$C_L = 100$ pF Typical for $V_{IN} = 5V$ ( <b>Note 1</b> )
<b>Error Amplifier (A1)</b>						
Input Offset Voltage	$V_{OS}$	-5	-0.6	+5	mV	
A1 Input Bias Current	$I_{BIAS}$	—	0.05	1	$\mu A$	
Error Amplifier PSRR	PSRR	—	85.4	—	dB	$V_{IN} = 3.0V$ to $5.0V$ , $V_{CM} = 1.2V$
Common Mode Input Range	$V_{CM}$	GND - 0.3	—	$V_{IN}$	V	
Common Mode Rejection Ratio		—	90	—	dB	$V_{IN} = 5V$ , $V_{CM} = 0V$ to $2.5V$
Open-loop Voltage Gain	$A_{VOL}$	80	95	—	dB	$R_L = 5$ k $\Omega$ to $V_{IN}/2$ , $100$ mV $< V_{EAOUT} < V_{IN} - 100$ mV, $V_{CM} = 1.2V$
Low-level Output	$V_{OL}$	—	25	GND + 65	mV	$R_L = 5$ k $\Omega$ to $V_{IN}/2$
Gain Bandwidth Product	GBWP	—	3.5	—	MHz	$V_{IN} = 5V$
Error Amplifier Sink Current	$I_{SINK}$	4	12	—	mA	$V_{IN} = 5V$ , $V_{REF} = 1.2V$ , $V_{FB} = 1.4V$ , $V_{COMP} = 2.0V$
Error Amplifier Source Current	$I_{SOURCE}$	-2	-9.8	—	mA	$V_{IN} = 5V$ , $V_{REF} = 1.2V$ , $V_{FB} = 1.0V$ , $V_{COMP} = 2.0V$ , Absolute Value
<b>Current Sense (CS) Amplifier (A2)</b>						
Input Offset Voltage	$V_{OS}$	-3.0	1.2	+3.0	mV	
CS Input Bias Current	$I_{BIAS}$	—	0.13	1	$\mu A$	
CS Amplifier PSRR	PSRR	—	65	—	dB	$V_{IN} = 3.0V$ to $5.0V$ , $V_{CM} = 0.12V$ , GAIN = 10
Closed-loop Voltage Gain	$A_{2VCL}$	—	10	—	V/V	$R_L = 5$ k $\Omega$ to $V_{IN}/2$ , $100$ mV $< V_{OUT} < V_{IN} - 100$ mV, $V_{CM} = +0.12V$
Low-level Output	$V_{OL}$	5	11	GND + 50	mV	$R_L = 5$ k $\Omega$ to $V_{IN}/2$
CS Sink Current	$I_{SINK}$	5	17.7	—	mA	
CS Amplifier Source Current	$I_{SOURCE}$	-5	-19.5	—	mA	
<b>Voltage Sense (VS) Amplifier (A3)</b>						
Input Offset Voltage	$V_{OS}$	-5	0.9	+5	mV	
VS Input Bias Current	$I_{BIAS}$	—	0.001	1	$\mu A$	

- Note 1:** External Oscillator Input ( $OSC_{IN}$ ) rise and fall times between 10 ns and 10  $\mu s$  were determined during device characterization testing. Signal levels between 0.8V and 2.0V with rise and fall times measured between 10% and 90% of maximum and minimum values. Not production tested. Additional timing specifications were fully characterized and specified that are not production tested.
- 2:** The minimum  $V_{IN}$  must meet two conditions:  $V_{IN} \geq 3.5V$  and  $V_{IN} \geq (V_{OUT(MAX)} + V_{DROPOUT(MAX)})$ .
- 3:**  $TCV_{OUT} = (V_{OUT-HIGH} - V_{OUT-LOW}) * 10^6 / (V_R * \Delta Temperature)$ ,  $V_{OUT-HIGH}$  = highest voltage measured over the temperature range.  $V_{OUT-LOW}$  = lowest voltage measured over the temperature range.
- 4:** Load regulation is measured at a constant junction temperature using low duty cycle pulse testing. Changes in output voltage due to heating effects are determined using thermal regulation specification  $TCV_{OUT}$ .
- 5:** Dropout voltage is defined as the input to output differential at which the output voltage drops 2% below its measured value with an applied input voltage of  $V_{OUT(MAX)} + V_{DROPOUT(MAX)}$  or 3.5V, whichever is greater.

# MCP1631/HV/MCP1631V/VHV

## DC CHARACTERISTICS (CONTINUED)

<b>Electrical Specifications:</b> Unless otherwise noted, $V_{IN} = 3.0V$ to $5.5V$ , $F_{OSC} = 1$ MHz with 10% Duty Cycle, $C_{IN} = 0.1$ $\mu F$ , $V_{DD}$ for typical values = $5.0V$ , $T_A$ for typical values = $+25^{\circ}C$ , $T_A = -40^{\circ}C$ to $+125^{\circ}C$ for all minimum and maximums.						
Parameters	Sym	Min	Typ	Max	Units	Conditions
VS Amplifier PSRR	PSRR	—	65	—	dB	$V_{IN} = 3.0V$ to $5.0V$ , $V_{CM} = 1.2V$
Common Mode Input Range	$V_{CM}$	GND	—	$AV_{DD}$	V	Rail to Rail Input
Closed-loop Voltage Gain	$A_{3V_{CL}}$	—	1	—	V/V	$R_L = 5$ k $\Omega$ to $V_{IN}/2$ , $100$ mV < $V_{EAOUT} < V_{IN} - 100$ mV, $V_{CM} = 1.2V$
Low-level Output	$V_{OL}$	—	38	GND + 85	mV	$RL = 5$ k $\Omega$ to $V_{IN}/2$
VS Amplifier Sink Current	$I_{SINK}$	1	5	—	mA	
VS Amplifier Source Current	$I_{SOURCE}$	-2	-5	—	mA	
<b>Peak Current Sense Input (C1)</b>						
Maximum Current Sense Signal MCP1631/MCP1631HV	$V_{CS\_MAX}$	0.85	0.9	0.98	V	
Maximum Ramp Signal MCP1631V/MCP1631VHV	$V_{RAMP}$	2.7	2.78	2.9	V	$V_{IN} > 4V$ Maximum CS input range limited by comparator input common mode range. $V_{CS\_MAX} = V_{IN} - 1.4V$
Current Sense Input Bias Current	$I_{CS\_B}$	—	-0.1	—	$\mu A$	$V_{IN} = 5V$
Delay From CS to $V_{EXT}$ MCP1631	$T_{CS\_VEXT}$	—	8.5	25	ns	<b>Note 1</b>
Minimum Duty Cycle	$DC_{MIN}$	—	—	0	%	$V_{FB} = V_{REF} + 0.1V$ , $V_{CS} = GND$
<b>Overvoltage Sense Comparator (C2)</b>						
OV Reference Voltage High	$OV_{VREF\_H}$	—	1.23	—	V	
OV Reference Voltage Low	$OV_{VREF\_L}$	1.15	1.18	1.23	V	
OV Hysteresis	$OV_{HYS}$	—	50	—	mV	Overvoltage Comparator Hysteresis
OV_IN Bias Current	$OV_{IBIAS}$	—	0.001	1	$\mu A$	
Delay From OV to $V_{EXT}$	$T_{OV\_VEXT}$	—	63	150	ns	Delay from OV detection to PWM termination ( <b>Note 1</b> )
OV Input Capacitance	$C_{OV}$	—	5	—	pF	
<b>Internal Regulator HV Options Input / Output Characteristics</b>						
Input Operating Voltage	$V_{IN}$	3.5	—	16.0	V	<b>Note 2</b>
Maximum Output Current	$I_{OUT\_mA}$	250	—	—	mA	
Output Short Circuit Current	$I_{OUT\_SC}$	—	400	—	mA	$V_{IN} = V_{IN(MIN)}$ ( <b>Note 2</b> ), $V_{OUT} = GND$ , Current (average current) measured 10 ms after short is applied.
Output Voltage Regulation	$V_{OUT}$	$V_R - 3.0\%$	$V_R \pm 0.4\%$	$V_R + 3.0\%$	V	$V_R = 3.3V$ or $5.0V$
$V_{OUT}$ Temperature Coefficient	$TCV_{OUT}$	—	50	150	ppm/ $^{\circ}C$	<b>Note 3</b>

**Note 1:** External Oscillator Input ( $OSC_{IN}$ ) rise and fall times between 10 ns and 10  $\mu s$  were determined during device characterization testing. Signal levels between 0.8V and 2.0V with rise and fall times measured between 10% and 90% of maximum and minimum values. Not production tested. Additional timing specifications were fully characterized and specified that are not production tested.

**2:** The minimum  $V_{IN}$  must meet two conditions:  $V_{IN} \geq 3.5V$  and  $V_{IN} \geq (V_{OUT(MAX)} + V_{DROPOUT(MAX)})$ .

**3:**  $TCV_{OUT} = (V_{OUT-HIGH} - V_{OUT-LOW}) * 10^6 / (V_R * \Delta Temperature)$ ,  $V_{OUT-HIGH}$  = highest voltage measured over the temperature range.  $V_{OUT-LOW}$  = lowest voltage measured over the temperature range.

**4:** Load regulation is measured at a constant junction temperature using low duty cycle pulse testing. Changes in output voltage due to heating effects are determined using thermal regulation specification  $TCV_{OUT}$ .

**5:** Dropout voltage is defined as the input to output differential at which the output voltage drops 2% below its measured value with an applied input voltage of  $V_{OUT(MAX)} + V_{DROPOUT(MAX)}$  or 3.5V, whichever is greater.

# MCP1631/HV/MCP1631V/VHV

## DC CHARACTERISTICS (CONTINUED)

<b>Electrical Specifications:</b> Unless otherwise noted, $V_{IN} = 3.0V$ to $5.5V$ , $F_{OSC} = 1$ MHz with 10% Duty Cycle, $C_{IN} = 0.1 \mu F$ , $V_{DD}$ for typical values = $5.0V$ , $T_A$ for typical values = $+25^\circ C$ , $T_A = -40^\circ C$ to $+125^\circ C$ for all minimum and maximums.						
Parameters	Sym	Min	Typ	Max	Units	Conditions
Line Regulation	$\frac{\Delta V_{OUT}}{V_{OUT} \times \frac{\Delta V_{IN}}{V_{IN}}}$	-0.3	$\pm 0.1$	+0.3	%/V	$(V_{OUT(MAX)} + V_{DROPOUT(MAX)}) \leq V_{IN} \leq 16V$ <b>Note 2</b>
Load Regulation	$\frac{\Delta V_{OUT}}{V_{OUT}}$	-2.5	$\pm 1.0$	+2.5	%	$I_L = 1.0$ mA to 250 mA, <b>Note 4</b>
Dropout Voltage <b>Note 2, Note 5</b>	$V_{DROPOUT}$	—	330	650	mV	$I_L = 250$ mA, $V_R = 5.0V$
		—	525	725	mV	$I_L = 250$ mA, $V_R = 3.3V$
Output Delay Time	$T_{DELAY}$	—	1000	—	$\mu s$	$V_{IN} = 0V$ to $6V$ , $V_{OUT} = 90\% V_R$ , $R_L = 50\Omega$ resistive
Output Noise	$e_N$	—	8	—	$\mu V / (Hz)^{1/2}$	$I_L = 50$ mA, $f = 1$ kHz, $C_{OUT} = 1 \mu F$
Power Supply Ripple Rejection Ratio	PSRR	—	44	—	dB	$f = 100$ Hz, $C_{OUT} = 1 \mu F$ , $I_L = 100 \mu A$ , $V_{INAC} = 100$ mV pk-pk, $C_{IN} = 0 \mu F$ , $V_R = 1.2V$
<b>Protection Features</b>						
Thermal Shutdown	$T_{SHD}$	—	150	—	$^\circ C$	
Thermal Shutdown Hysteresis	$T_{SHD\_HYS}$	—	18	—	$^\circ C$	

- Note 1:** External Oscillator Input ( $OSC_{IN}$ ) rise and fall times between 10 ns and 10  $\mu s$  were determined during device characterization testing. Signal levels between 0.8V and 2.0V with rise and fall times measured between 10% and 90% of maximum and minimum values. Not production tested. Additional timing specifications were fully characterized and specified that are not production tested.
- Note 2:** The minimum  $V_{IN}$  must meet two conditions:  $V_{IN} \geq 3.5V$  and  $V_{IN} \geq (V_{OUT(MAX)} + V_{DROPOUT(MAX)})$ .
- Note 3:**  $TCV_{OUT} = (V_{OUT-HIGH} - V_{OUT-LOW}) * 10^6 / (V_R * \Delta Temperature)$ ,  $V_{OUT-HIGH}$  = highest voltage measured over the temperature range.  $V_{OUT-LOW}$  = lowest voltage measured over the temperature range.
- Note 4:** Load regulation is measured at a constant junction temperature using low duty cycle pulse testing. Changes in output voltage due to heating effects are determined using thermal regulation specification  $TCV_{OUT}$ .
- Note 5:** Dropout voltage is defined as the input to output differential at which the output voltage drops 2% below its measured value with an applied input voltage of  $V_{OUT(MAX)} + V_{DROPOUT(MAX)}$  or 3.5V, whichever is greater.

## TEMPERATURE SPECIFICATIONS

<b>Electrical Specifications:</b> Unless otherwise indicated, all limits are specified for: $V_{IN} + 3.0V$ to $5.5V$						
Parameters	Sym	Min	Typ	Max	Units	Conditions
<b>Temperature Ranges</b>						
Operating Junction Temperature Range	$T_J$	-40	—	+125	$^\circ C$	Steady State
Storage Temperature Range	$T_A$	-65	—	+150	$^\circ C$	
Maximum Junction Temperature	$T_J$	—	—	+150	$^\circ C$	Transient
<b>Package Thermal Resistances</b>						
Thermal Resistance, 20L-TSSOP	$\theta_{JA}$	—	90	—	$^\circ C/W$	Typical 4 Layer board with interconnecting vias
Thermal Resistance, 20L-SSOP	$\theta_{JA}$	—	89.3	—	$^\circ C/W$	Typical 4 Layer board with interconnecting vias
Thermal Resistance, 20L-QFN	$\theta_{JA}$	—	43	—	$^\circ C/W$	Typical 4 Layer board with interconnecting vias



## 2.0 TYPICAL PERFORMANCE CURVES

**Note:** The graphs and tables provided following this note are a statistical summary based on a limited number of samples and are provided for informational purposes only. The performance characteristics listed herein are not tested or guaranteed. In some graphs or tables, the data presented may be outside the specified operating range (e.g., outside specified power supply range) and therefore outside the warranted range.

**Note:** Unless otherwise noted,  $V_{IN} = 3.0V$  to  $5.5V$ ,  $F_{OSC} = 1$  MHz with 10% Duty Cycle,  $C_{IN} = 0.1$   $\mu F$ ,  $V_{IN}$  for typical values =  $5.0V$ ,  $T_A$  for typical values =  $+25^\circ C$ .

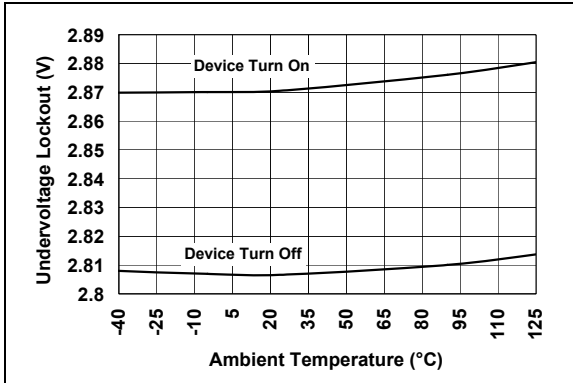

**FIGURE 2-1:** Undervoltage Lockout vs. Temperature.

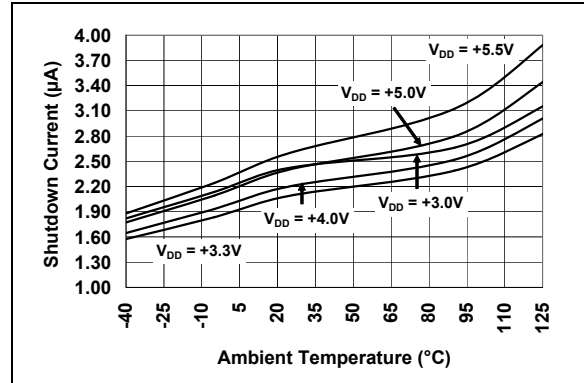

**FIGURE 2-4:** Shutdown Current vs. Temperature (MCP1631/MCP1631V).

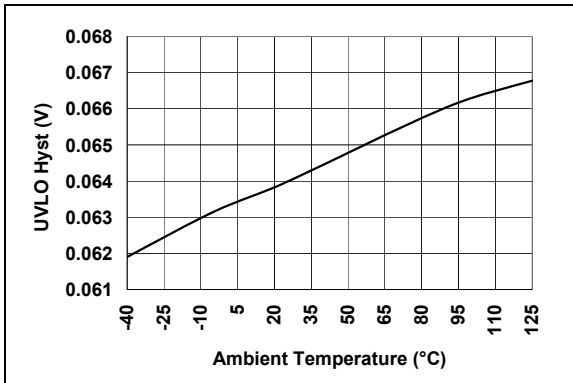

**FIGURE 2-2:** Undervoltage Lockout Hysteresis vs. Temperature.

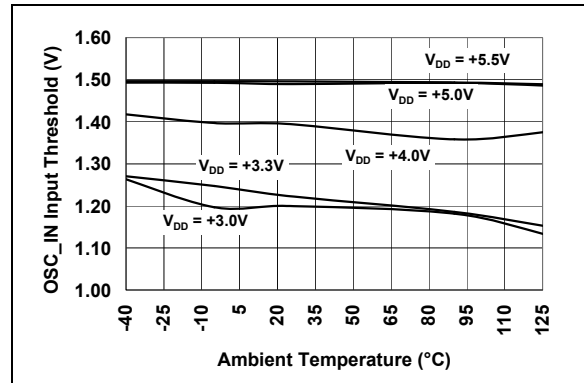

**FIGURE 2-5:** Oscillator Input Threshold vs. Temperature.

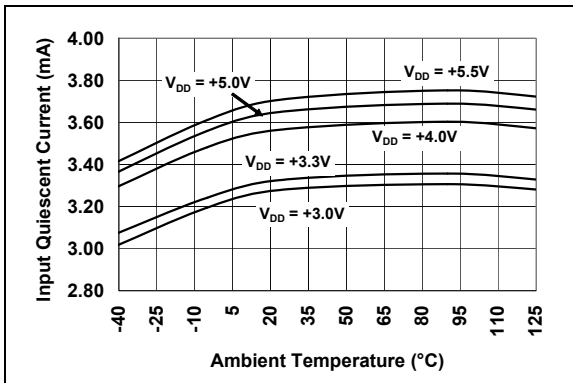

**FIGURE 2-3:** Input Quiescent Current vs. Temperature.

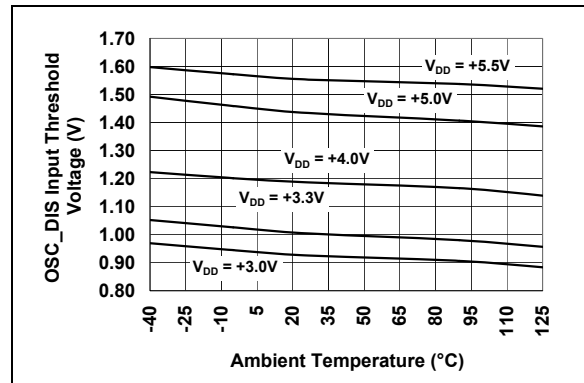
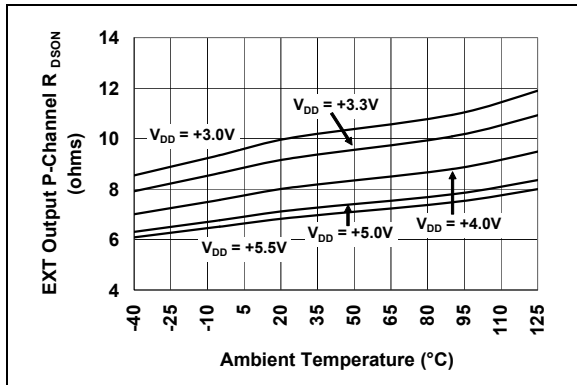

**FIGURE 2-6:** Oscillator Disable Input Threshold vs. Temperature.

# MCP1631/HV/MCP1631V/VHV

## Typical Performance Curves (Continued)

**Note:** Unless otherwise noted,  $V_{IN} = 3.0V$  to  $5.5V$ ,  $F_{OSC} = 1$  MHz with 10% Duty Cycle,  $C_{IN} = 0.1 \mu F$ ,  $V_{IN}$  for typical values =  $5.0V$ ,  $T_A$  for typical values =  $+25^\circ C$ .



**FIGURE 2-7:**  $V_{EXT}$  P-Channel Driver  $R_{DSON}$  vs. Temperature.

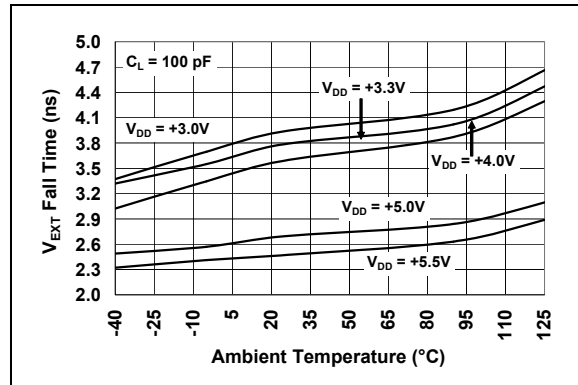

**FIGURE 2-10:**  $V_{EXT}$  Fall Time vs. Temperature.

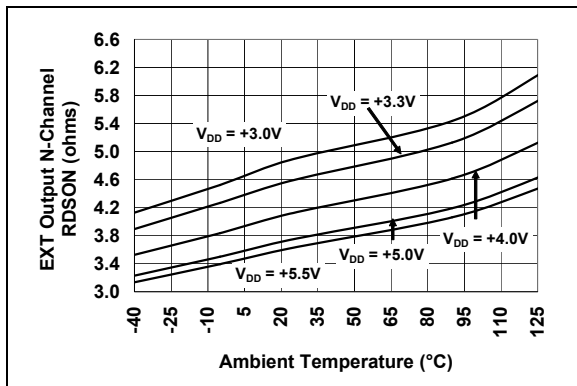

**FIGURE 2-8:**  $V_{EXT}$  N-Channel Driver  $R_{DSON}$  vs. Temperature.

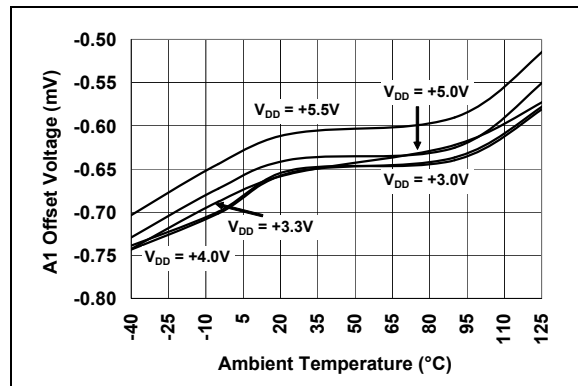

**FIGURE 2-11:** Amplifier A1 Offset Voltage vs. Temperature.

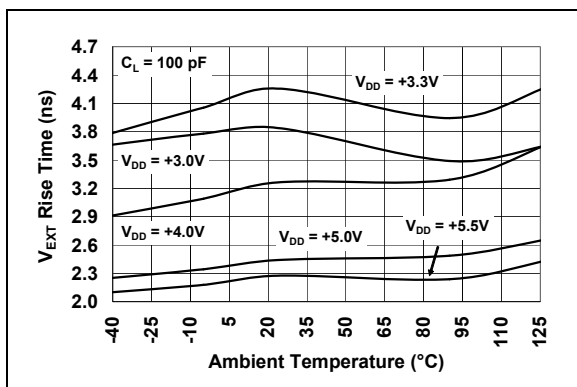

**FIGURE 2-9:**  $V_{EXT}$  Rise Time vs. Temperature.

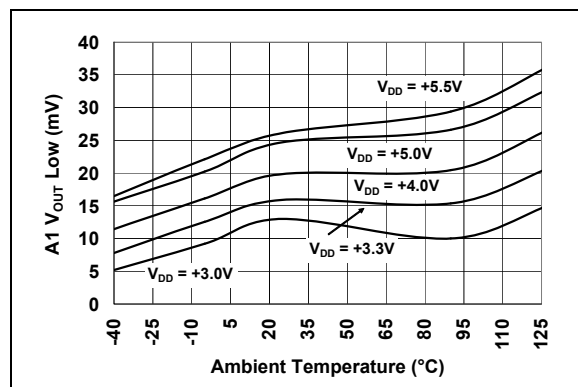

**FIGURE 2-12:** Amplifier A1 Output Voltage Low vs. Temperature.

## Typical Performance Curves (Continued)

**Note:** Unless otherwise noted,  $V_{IN} = 3.0V$  to  $5.5V$ ,  $F_{OSC} = 1$  MHz with 10% Duty Cycle,  $C_{IN} = 0.1$   $\mu F$ ,  $V_{IN}$  for typical values =  $5.0V$ ,  $T_A$  for typical values =  $+25^\circ C$ .

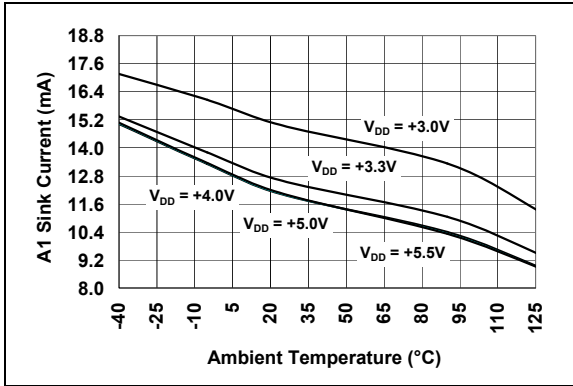

**FIGURE 2-13:** Amplifier A1 Sink Current vs. Temperature.

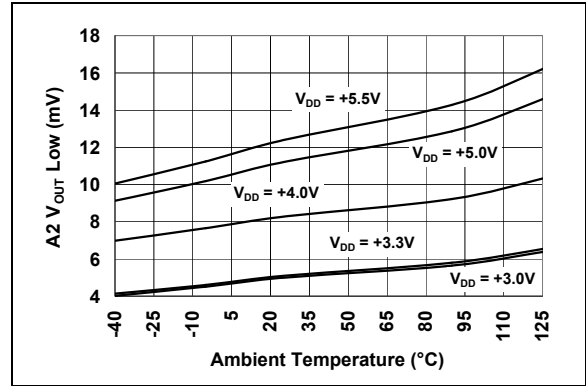

**FIGURE 2-16:** Amplifier A2 Output Voltage Low vs. Temperature.

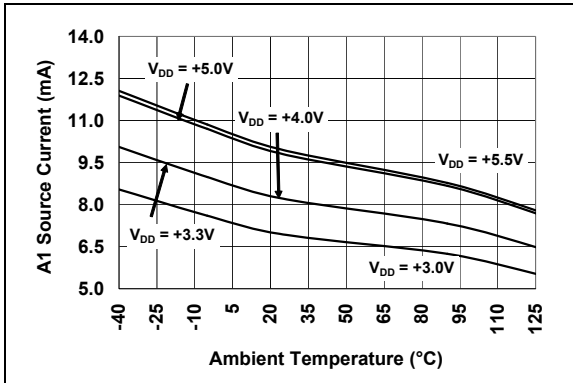

**FIGURE 2-14:** Amplifier A1 Source Current vs. Temperature.

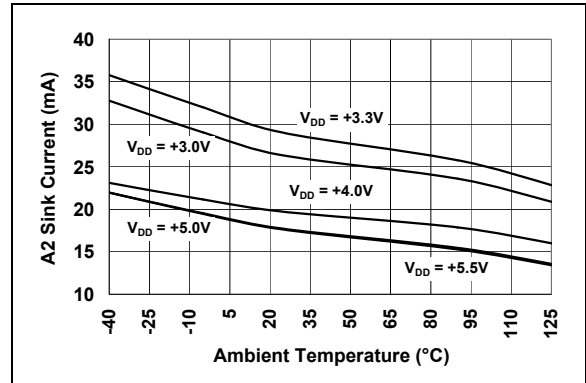

**FIGURE 2-17:** Amplifier A2 Sink Current vs. Temperature.

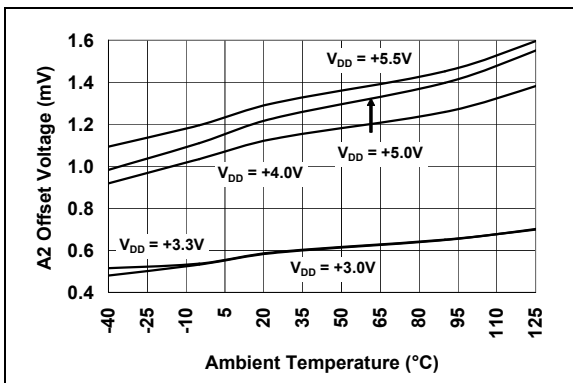

**FIGURE 2-15:** Amplifier A2 Offset Voltage vs. Temperature.

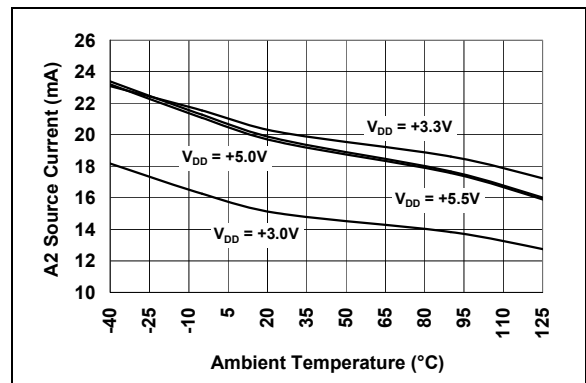
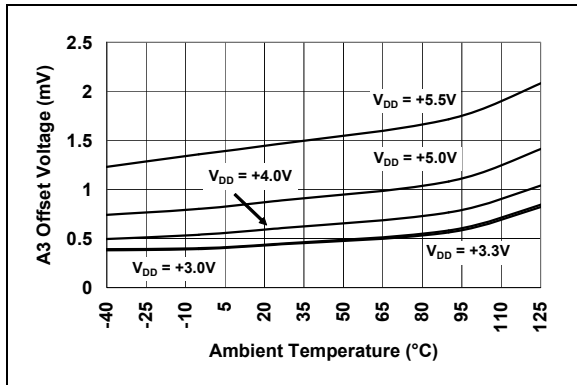

**FIGURE 2-18:** Amplifier A2 Source Current vs. Temperature.

# MCP1631/HV/MCP1631V/VHV

## Typical Performance Curves (Continued)

**Note:** Unless otherwise noted,  $V_{IN} = 3.0V$  to  $5.5V$ ,  $F_{OSC} = 1\text{ MHz}$  with 10% Duty Cycle,  $C_{IN} = 0.1\ \mu\text{F}$ ,  $V_{IN}$  for typical values =  $5.0V$ ,  $T_A$  for typical values =  $+25^\circ\text{C}$ .



**FIGURE 2-19:** Amplifier A3 Offset Voltage vs. Temperature.

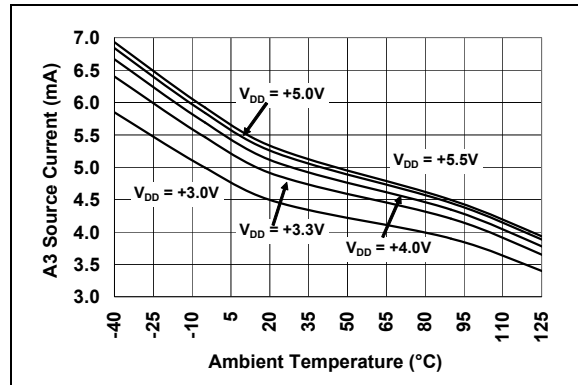

**FIGURE 2-22:** Amplifier A3 Source Current vs. Temperature.

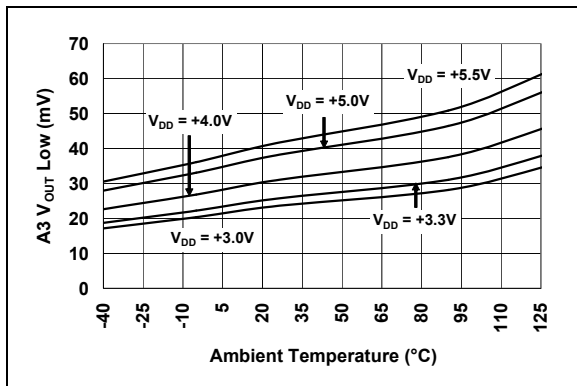

**FIGURE 2-20:** Amplifier A3 Output Voltage Low vs. Temperature.

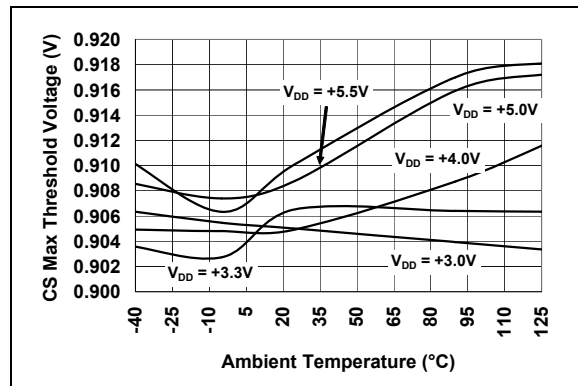

**FIGURE 2-23:** MCP1631 and MCP1631HV CS Maximum Voltage (V) vs. Temperature.

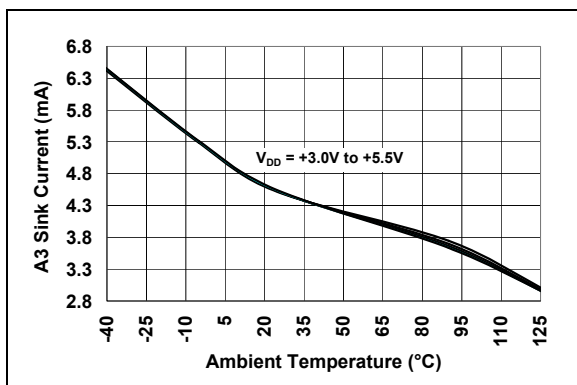

**FIGURE 2-21:** Amplifier A3 Sink Current vs. Temperature.

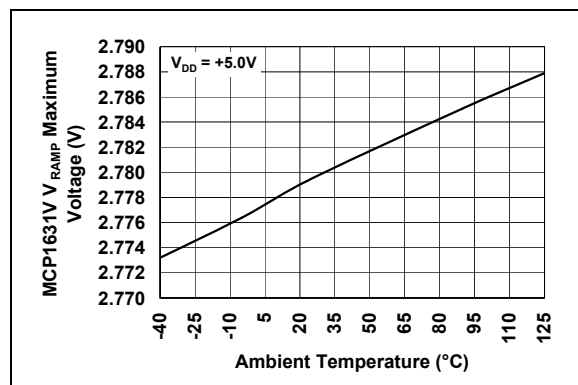

**FIGURE 2-24:** MCP1631V and MCP1631VHV  $V_{RAMP}$  Max Voltage (V).

## Typical Performance Curves (Continued)

**Note:** Unless otherwise noted,  $V_{IN} = 3.0V$  to  $5.5V$ ,  $F_{OSC} = 1$  MHz with 10% Duty Cycle,  $C_{IN} = 0.1$   $\mu F$ ,  $V_{IN}$  for typical values =  $5.0V$ ,  $T_A$  for typical values =  $+25^\circ C$ .

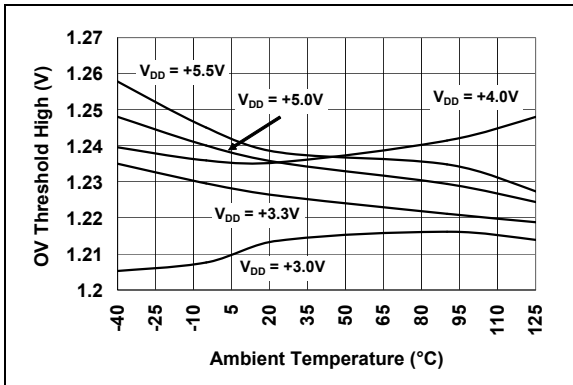

**FIGURE 2-25:** Overtolerance Threshold High (V) vs. Temperature.

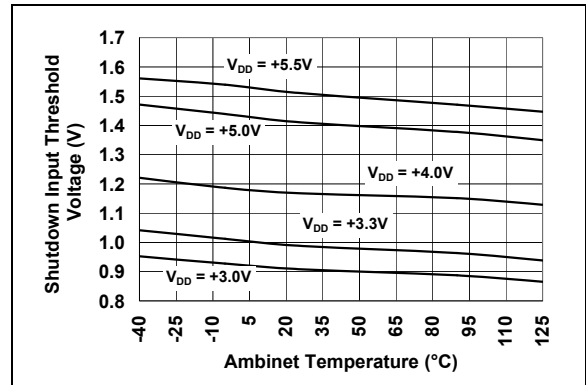

**FIGURE 2-28:** Shutdown Input Voltage Threshold (V) vs. Temperature.

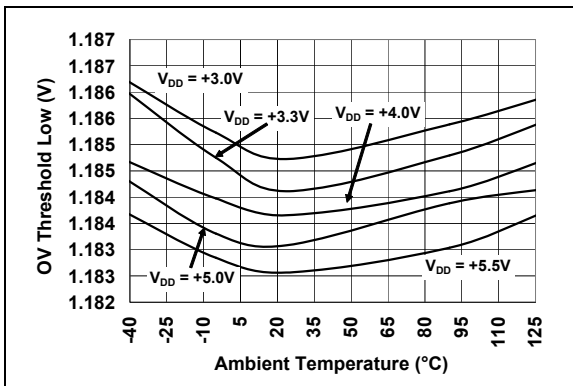

**FIGURE 2-26:** Overtolerance Threshold Low (V) vs. Temperature.

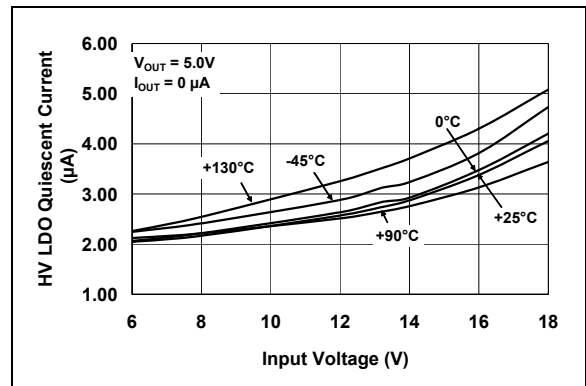

**FIGURE 2-29:** LDO Quiescent Current vs. Input Voltage.

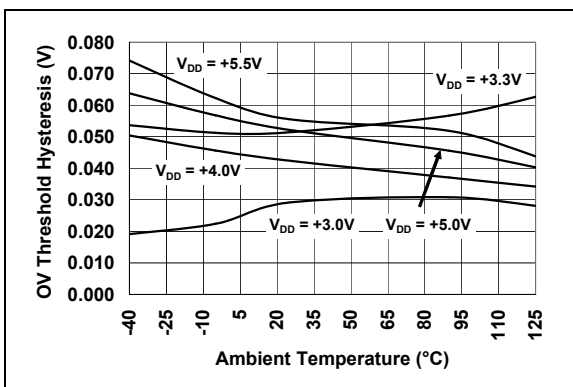

**FIGURE 2-27:** Overtolerance Threshold Hysteresis (V) vs. Temperature.

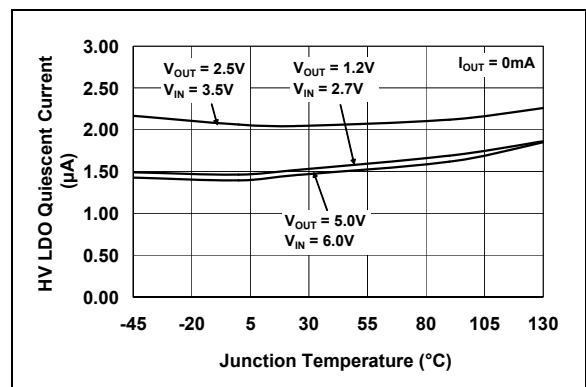
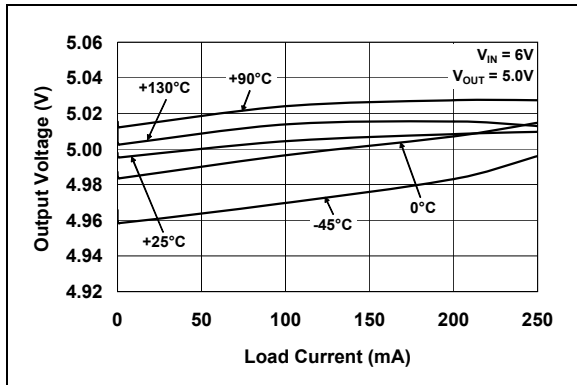

**FIGURE 2-30:** LDO Quiescent Current vs. Junction Temperature.

# MCP1631/HV/MCP1631V/VHV

## Typical Performance Curves (Continued)

**Note:** Unless otherwise noted,  $V_{IN} = 3.0V$  to  $5.5V$ ,  $F_{OSC} = 1$  MHz with 10% Duty Cycle,  $C_{IN} = 0.1 \mu F$ ,  $V_{IN}$  for typical values =  $5.0V$ ,  $T_A$  for typical values =  $+25^\circ C$ .



**FIGURE 2-31:** LDO Output Voltage vs. Load Current.

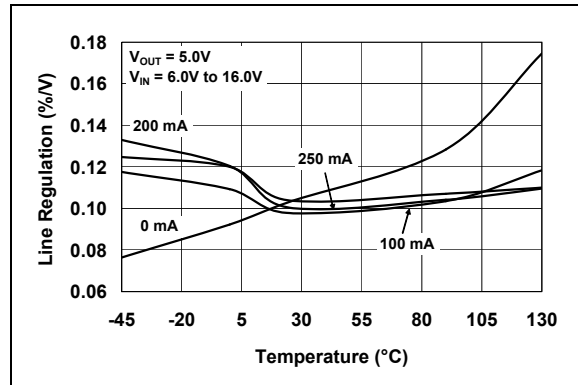

**FIGURE 2-34:** LDO Line Regulation vs. Temperature.

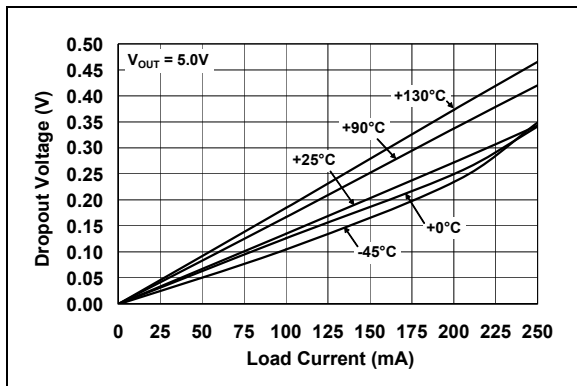

**FIGURE 2-32:** LDO Dropout Voltage vs. Load Current.

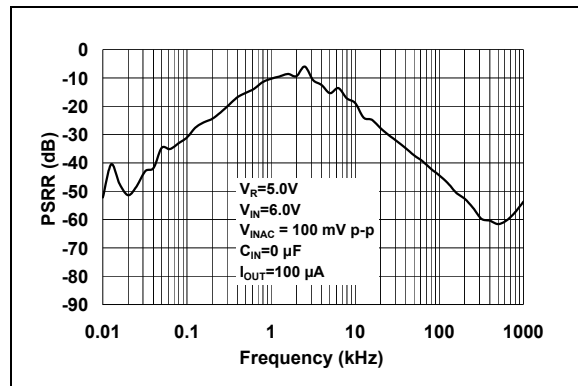

**FIGURE 2-35:** LDO PSRR vs. Frequency.

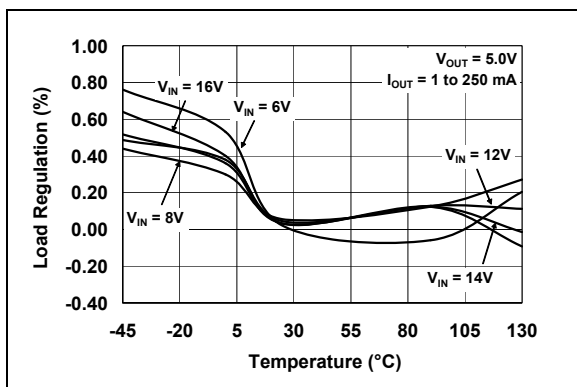

**FIGURE 2-33:** LDO Load Regulation vs. Temperature.

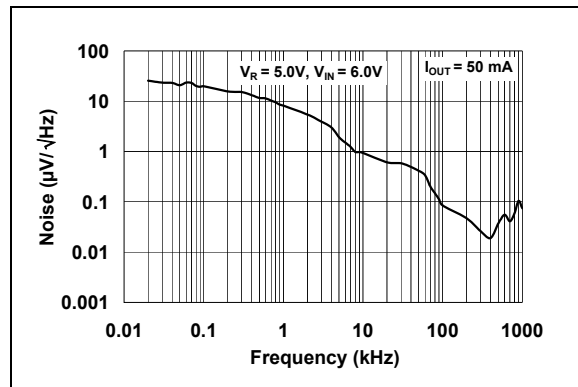

**FIGURE 2-36:** LDO Output Noise vs. Frequency.

# MCP1631/HV/MCP1631V/VHV

## 3.0 PIN DESCRIPTIONS

The descriptions of the pins are listed in [Table 3-1](#).

**TABLE 3-1: PIN FUNCTION TABLE**

MCP1631/MCP1631V		MCP1631HV/ MCP1631VHV	Sym	Description
TSSOP/SSOP	4x4 QFN	TSSOP/SSOP		
1	15	1	P <sub>GND</sub>	Power ground return
2	16	2	SHDN	Shutdown input
3	17	3	OSC <sub>IN</sub>	External oscillator input
4	18	4	OSC <sub>DIS</sub>	Oscillator disable input
5	19	5	OV <sub>IN</sub>	Overvoltage comparator input
6	20	6	V <sub>REF</sub>	External voltage reference input
7	1	7	A <sub>GND</sub>	Quiet or analog ground
8,9,10	2,4,12	8,9	NC	No connection
—	—	10	V <sub>IN</sub>	High voltage input
11	3	—	A <sub>VDD_IN</sub>	Analog bias voltage input
—	—	11	A <sub>VDD_OUT</sub>	Regulated V <sub>DD</sub> output
12	5	12	V <sub>SIN</sub>	Voltage sense amplifier (A3) input
13	6	13	I <sub>SIN</sub>	Current sense input
14	7	14	V <sub>SOUT</sub>	Voltage sense amplifier output
15	8	15	I <sub>SOUT</sub>	Current sense amplifier output
16	9	16	COMP	Error amplifier (A1) output
17	10	17	FB	Error amplifier inverting input (A1)
18	11	18	CS/V <sub>RAMP</sub>	CS - current sense input; V <sub>RAMP</sub> voltage ramp input
19	13	19	P <sub>VDD</sub>	Power V <sub>DD</sub> input
20	14	20	V <sub>EXT</sub>	External driver output
—	21	—	EP	Exposed Thermal Pad (EP); must be connected to A <sub>GND</sub>

### 3.1 Power Ground (P<sub>GND</sub>)

Connect power ground return pin to power ground plane, high peak current flows through the P<sub>GND</sub> during the turn on and turn off the external MOSFET devices.

### 3.2 Shutdown Input (SHDN)

Shutdown input logic low disables device and lowers I<sub>Q</sub> to minimum value, amplifier A3 (VS) remains functional for battery voltage sense applications.

### 3.3 Oscillator Input (OSC<sub>IN</sub>)

External Oscillator Input, used to set power train switching frequency and maximum duty cycle, V<sub>EXT</sub> enabled while low and disabled while high.

### 3.4 Oscillator Disable (OSC<sub>DIS</sub>)

Oscillator disable input, used to asynchronously terminate the V<sub>EXT</sub> duty cycle. Commonly used to modulate current for LED driver applications. For minimum shutdown I<sub>Q</sub>, connect OSC<sub>DIS</sub> to SHDN.

### 3.5 Overvoltage Input (OV<sub>IN</sub>)

Overvoltage Comparator input, connect to voltage divider, internal comparator terminates V<sub>EXT</sub> output in 50 ns to limit output voltage to predetermined value.

### 3.6 External Reference Voltage Input (V<sub>REF</sub>)

External Voltage Reference input, connect fixed or variable external reference to V<sub>REF</sub>. With A1 configured as an error amplifier, the power supply output variable (voltage or current) will follow this input.

# MCP1631/HV/MCP1631V/VHV

---

## 3.7 Analog Ground ( $A_{GND}$ )

Quiet or analog ground, connect to analog ground plane to minimize noise on sensitive MCP1631 circuitry.

## 3.8 No Connection (NC)

No connection.

## 3.9 Input Voltage ( $V_{IN}$ )

High voltage input for MCP1631HV/MCP1631VHV devices, operates from 3.5V to 16V input supply.

## 3.10 Analog supply Input ( $A_{VDD\_IN}$ )

Analog bias input, minimum 3.0V to 5.5V operation for MCP1631/MCP1631V devices.

## 3.11 Analog Supply Output ( $A_{VDD\_OUT}$ )

Regulated  $V_{DD}$  output used to power internal MCP1631HV/MCP1631VHV and external microcontroller, supplies up to 250 ma of bias current at 3.3V or 5.0V regulated low drop out rail.

## 3.12 Voltage Sense Input ( $VS_{IN}$ )

Voltage sense amplifier (A3) input, connect to high impedance battery voltage resistor divider to sense battery voltage with minimal loading.

## 3.13 Current Sense Input ( $IS_{IN}$ )

Connect to SEPIC secondary side sense resistor to develop a regulated current source used to charge multi-chemistry batteries.

## 3.14 Voltage Sense Output ( $VS_{OUT}$ )

Voltage sense amplifier output, connect to microcontroller analog to digital converter to measure battery voltage.

## 3.15 Current Sense Output ( $IS_{OUT}$ )

Current sense amplifier output, connect to error amplifier (A1) inverting input (FB) to regulate SEPIC output current.

## 3.16 Error Amplifier Output (COMP)

Error amplifier (A1) output, connect control loop compensation from FB input to COMP output pin.

## 3.17 Feedback (FB)

Error amplifier input (A1), connect to current sense output amplifier (A2) to regulate current.

## 3.18 Current Sense or Voltage Ramp ( $CS/V_{RAMP}$ )

For MCP1631/MCP1631HV applications, connect to low side current sense of SEPIC switch for current mode control and peak current limit. For MCP1631/MCP1631HV application, connect artificial ramp voltage to  $V_{RAMP}$  input for voltage mode PWM control.

## 3.19 Power VDD ( $P_{VDD}$ )

Power  $V_{DD}$  input,  $V_{EXT}$  gate drive supply input, connect to +5.0V or +3.3V supply for driving external MOSFET.

## 3.20 External Driver ( $V_{EXT}$ )

High current driver output used to drive external MOSFET at high frequency, capable of 1A peak currents with +5.0V  $P_{VDD}$ .

## 3.21 Exposed PAD 4x4 QFN (EP)

There is an internal electrical connection between the Exposed Thermal Pad (EP) and the  $A_{GND}$  pin; they must be connected to the same potential on the Printed Circuit Board (PCB).



## 4.0 DETAILED DESCRIPTION

### 4.1 Device Overview

The MCP1631/MCP1631V device family combines the analog functions to develop high frequency switch mode power systems while integrating features for battery charger and LED current source applications. With the integration of a MOSFET driver, voltage sense, current sense and over voltage protection, the MCP1631/MCP1631V is a highly integrated, high-speed analog pulse width modulator.

The MCP1631/MCP1631V output ( $V_{EXT}$ ) is used to control the switch of the power system (on and off time). By controlling the switch on and off time, the power system output can be regulated. With the oscillator and reference voltage as inputs, a simple interface to a microcontroller is available with the MCP1631/MCP1631V to develop intelligent power systems. A good example of an intelligent power system is a battery charger, programmable LED driver current source or programmable power supply.

The MCP1631/MCP1631V is a combination of specialty analog blocks consisting of a Pulse Width Modulator (PWM), MOSFET Driver, Current Sense Amplifier (A2), Voltage Sense Amplifier (A3), Overvoltage Comparator (C2) and additional features (Shutdown, Undervoltage Lockout, Overtemperature Protection). For the HV options, an internal low dropout regulator is integrated for operation from high voltage inputs (MCP1631HV/MCP1631VHV).

### 4.2 Pulse Width Modulator (PWM)

The internal PWM of the MCP1631/MCP1631V is comprised of an error amplifier, high-speed comparator and latch. The output of the amplifier is compared to either the MCP1631 CS (primary current sense input) or the MCP1631V  $V_{RAMP}$  (voltage mode ramp input) of the high speed comparator. When the CS or VRAMP signal reach the level of the error amplifier output, the on cycle is terminated and the external switch is latched off until the beginning of the next cycle (high to low transition of  $OSC_{IN}$ ).

### 4.3 $V_{EXT}$ MOSFET Driver

The MCP1631/MCP1631V output can be used to drive the external MOSFET directly for low side topology applications. The  $V_{EXT}$  is capable of sourcing up to 700 mA and sinking up to 1A of current from a  $P_{VDD}$  source of 5V. Typical output power using the  $V_{EXT}$  output to directly drive the external MOSFET can exceed 50W depending upon application and switching frequency.

### 4.4 Current Sense Amplifier (A2)

The A2 current sense amplifier is used to sense current in the secondary side of a SEPIC converter or freewheeling current in a Buck converter. The inverting amplifier has a built in voltage gain of ten with low offset and high speed.

### 4.5 Voltage Sense Amplifier (A3)

The A3 voltage sense amplifier is used to sense battery voltage. In battery powered applications, it is important to minimize the steady state load current draw on the battery. The voltage sense amplifier (A3) is used to buffer a high impedance series divider used to reduce the battery pack voltage to a level that can be read using an analog to digital converter. The voltage sense amplifier draws a very low quiescent current and remains functional when the MCP1631/MCP1631V is shutdown making it possible to read battery voltage without turning on the charger.

### 4.6 Overvoltage Comparator(C2)

The C2 overvoltage comparator is used to prevent the power system from being damaged when the load (battery) is disconnected. By comparing the divided down power train output voltage with a 1.2V internal reference voltage, the MCP1631/MCP1631V  $V_{EXT}$  output switching is interrupted when the output voltage is above a pre-set value. This limits the output voltage of the power train, the 0V comparator's hysteresis will operate as a ripple regulator.

### 4.7 Shutdown Input

The MCP1631/MCP1631V shutdown feature is used to disable the device with the exception of the voltage sense amplifier A3 to minimize quiescent current draw. While shutdown, A3 remains operational while the device draws 4.4  $\mu$ A from the input.

### 4.8 Protection

The MCP1631/MCP1631V has built in Undervoltage Lockout (UVLO) that ensures the output  $V_{EXT}$  pin is forced to a known state (low) when the input voltage or  $A_{VDD}$  is below the specified value. This prevents the main MOSFET switch from being turned on during a power up or down sequence.

The MCP1631/MCP1631V provides a thermal shutdown protection feature, if the internal junction temperature of the device becomes high, the overtemperature protection feature will disable (pull the  $V_{EXT}$  output low) and shut down the power train.

# MCP1631/HV/MCP1631V/VHV

---

NOTES:

## 5.0 APPLICATION INFORMATION

### 5.1 Typical Applications

The MCP1631/MCP1631V can be used to develop intelligent power management solutions, typical applications include a multi-chemistry battery charger used to charge Li-Ion, NiMH or NiCd batteries and constant current LED drivers.

### 5.2 Battery Charger Design Overview

The design approach for developing high current switching battery chargers using the MCP1631 is described in this section. Depending on input voltage range, there are two versions of the device that can be used to accommodate a very wide range of input voltages.

For a regulated input voltage range of 5V, the MCP1631/MCP1631V device is used, for this input voltage application (regulated ac-dc converter or USB input), the MCP1631/MCP1631V is powered directly from the 5V dc input.

For input voltages to +16V steady state with +18V transients, the MCP1631HV/MCP1631VHV, or high voltage option can be used. The high voltage devices integrate a low dropout (LDO) linear regulator with a set output voltage of +3.3V or +5.0V that internally powers the MCP1631HV/MCP1631VHV and is also capable of providing 250 mA of bias current for the attached microcontroller and other circuitry. MCP1631HV/MCP1631VHV internal power dissipation must be considered when loading the internal LDO regulator.

For higher input voltages the MCP1631/MCP1631V can be biased from an external regulated +3.0V to +5.5V supply.

### 5.3 Programmable Single Ended Primary Inductive (SEPIC) Current Source

The MCP1631/MCP1631V family integrates features that are necessary to develop programmable current sources. The SEPIC converter is commonly used in battery charger applications. The primary or input inductor is used to filter input current and minimize the switching noise at the converter input. The primary to secondary capacitive isolation blocks any dc path from input to output making the SEPIC safer than Buck or other non-isolated topologies. The SEPIC rectifier blocks the reverse path preventing battery leakage, in other topologies an additional diode for blocking is necessary adding additional components and efficiency loss.

The input or primary inductor and output or secondary inductor are typically constructed from a single magnetic device with two windings, this is commonly referred to as a coupled inductor. Using coupled

inductors has significant advantages in addition to the size and cost benefits of a single core with multiple windings.

### 5.4 Mixed Signal Design

For intelligent battery charger design, a microcontroller is used to generate the proper charge profile, charge termination, safety timers and battery charger features. When using the MCP1631/MCP1631V for Li-Ion battery charger applications, the microcontroller is also used to generate the constant voltage regulation phase of the charge cycle. This is accomplished by using the external reference feature of the MCP1631/MCP1631V as a programmable current source. The microcontroller is used to vary the  $V_{REF}$  input of the MCP1631/MCP1631V. The charge current into the battery is regulated by the MCP1631/MCP1631V, the level that it is regulated to is set by the programmability of the microcontroller.

The internal MCP1631/MCP1631V analog components are used to regulate the microcontroller programmed current. The secondary or battery current is sensed using amplifier A2, the output of A2 is feed into the input of the error amplifier A1, the output of A1 sets the peak switch current of the SEPIC converter, it increases or decreases the battery current to match its (A1) inputs. By increasing the  $V_{REF}$  or non-inverting input of A1, the battery current is increased.

### 5.5 Safety Features

The MCP1631/MCP1631V integrates a high-speed comparator used to protect the charger and battery from being exposed to high voltages if the battery is removed or opens. Comparator C2 is used to sense the SEPIC output voltage. If the divided down output voltage becomes higher than the 1.2V internal MCP1631/MCP1631V reference, the  $V_{EXT}$  PWM output is terminated within 50 ns preventing the build up of voltage on the SEPIC output.

Peak switch current is limited by the MCP1631/MCP1631V comparator C1 and error amplifier A1 output voltage clamp. For the MCP1631, the error amplifier output is clamped at 2.7V. The A1 output is divided down by 1/3 and compared with CS (current sense) input. The  $V_{EXT}$  output is turned off if the CS input reaches a level of 1/3 of 2.7V or 0.9V in 12 ns, preventing the external switch current from becoming high enough to damage the SEPIC power train.

Internal overtemperature protection limits the device junction temperature to 150°C preventing catastrophic failure for overtemperature conditions. Once the temperature decreases 10°C, the device will resume normal operation.

Safety timers are typically used to limit the amount of energy into a faulted battery or pack. This is accomplished using the microcontroller and MCP1631/MCP1631V shutdown feature.

# MCP1631/HV/MCP1631V/VHV

## 5.6 OSC Disable Feature

The oscillator disable or OSC\_DIS input is used to asynchronously terminate the PWM V<sub>EXT</sub> output. This can be used with a slow PWM input to modulate current into an LED for lighting applications.

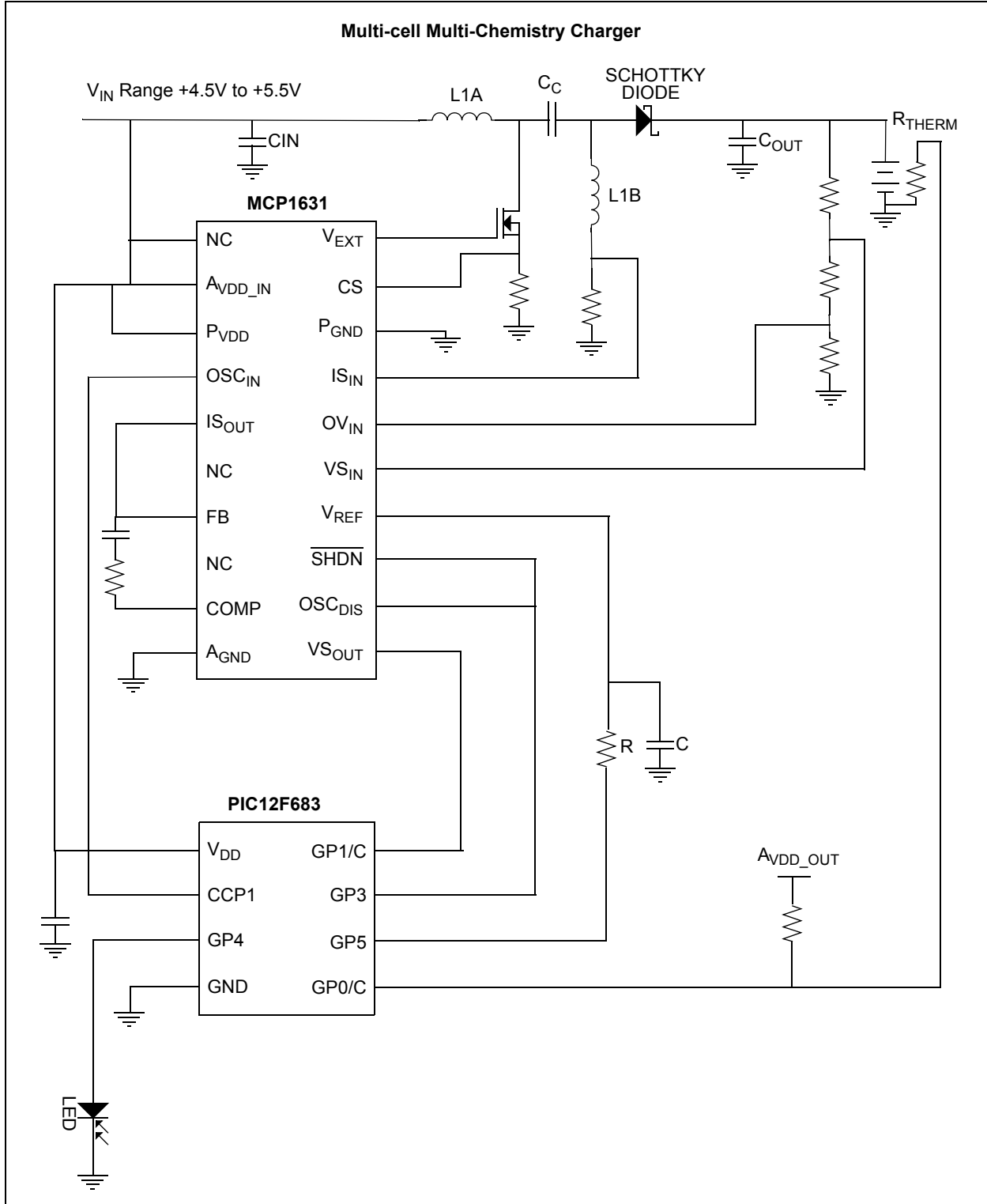

**FIGURE 5-1:** +5V ac-dc or USB Input Application.

# MCP1631/HV/MCP1631V/VHV

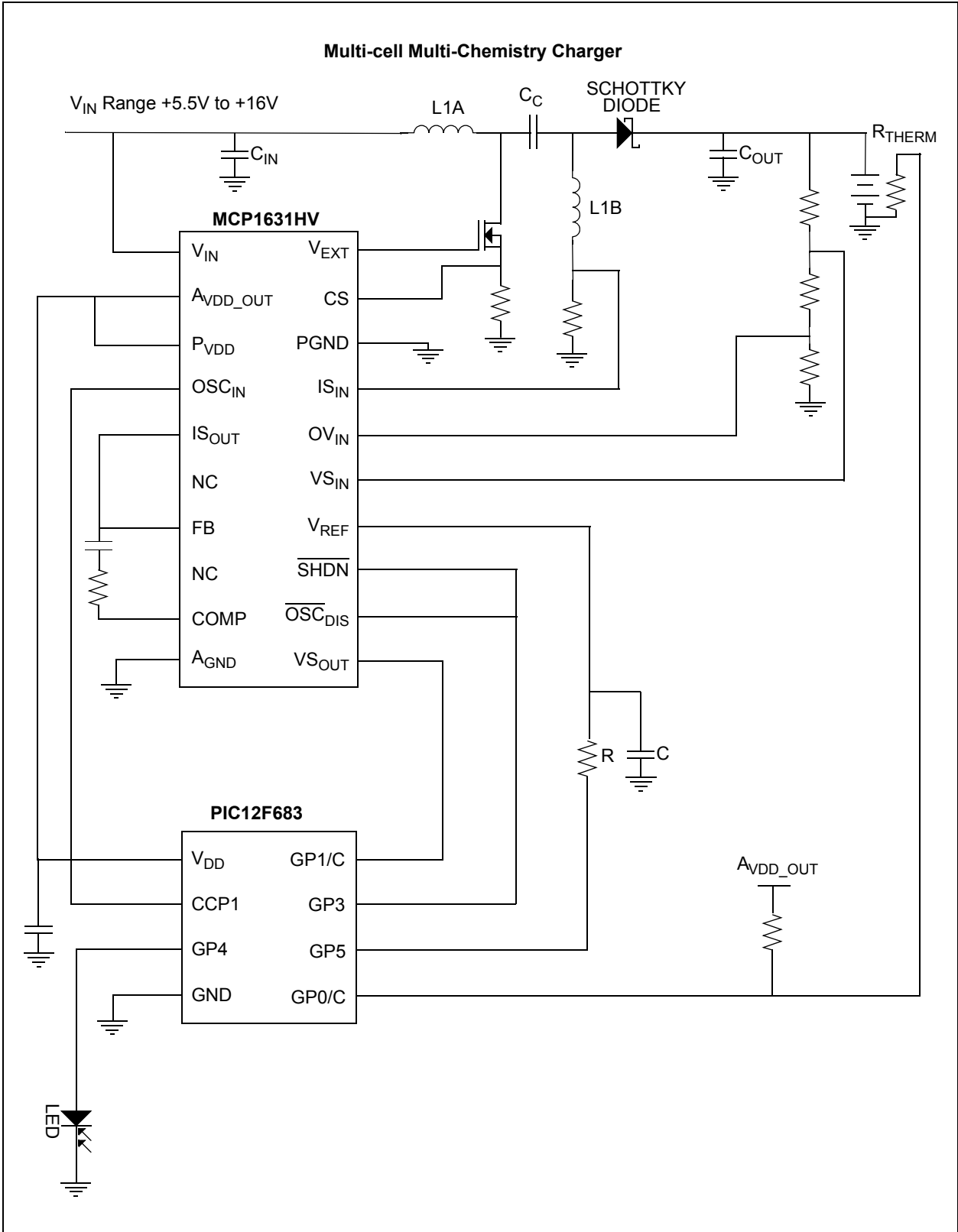

**FIGURE 5-2:** +5.5V to +16.0V Input.

# MCP1631/HV/MCP1631V/VHV

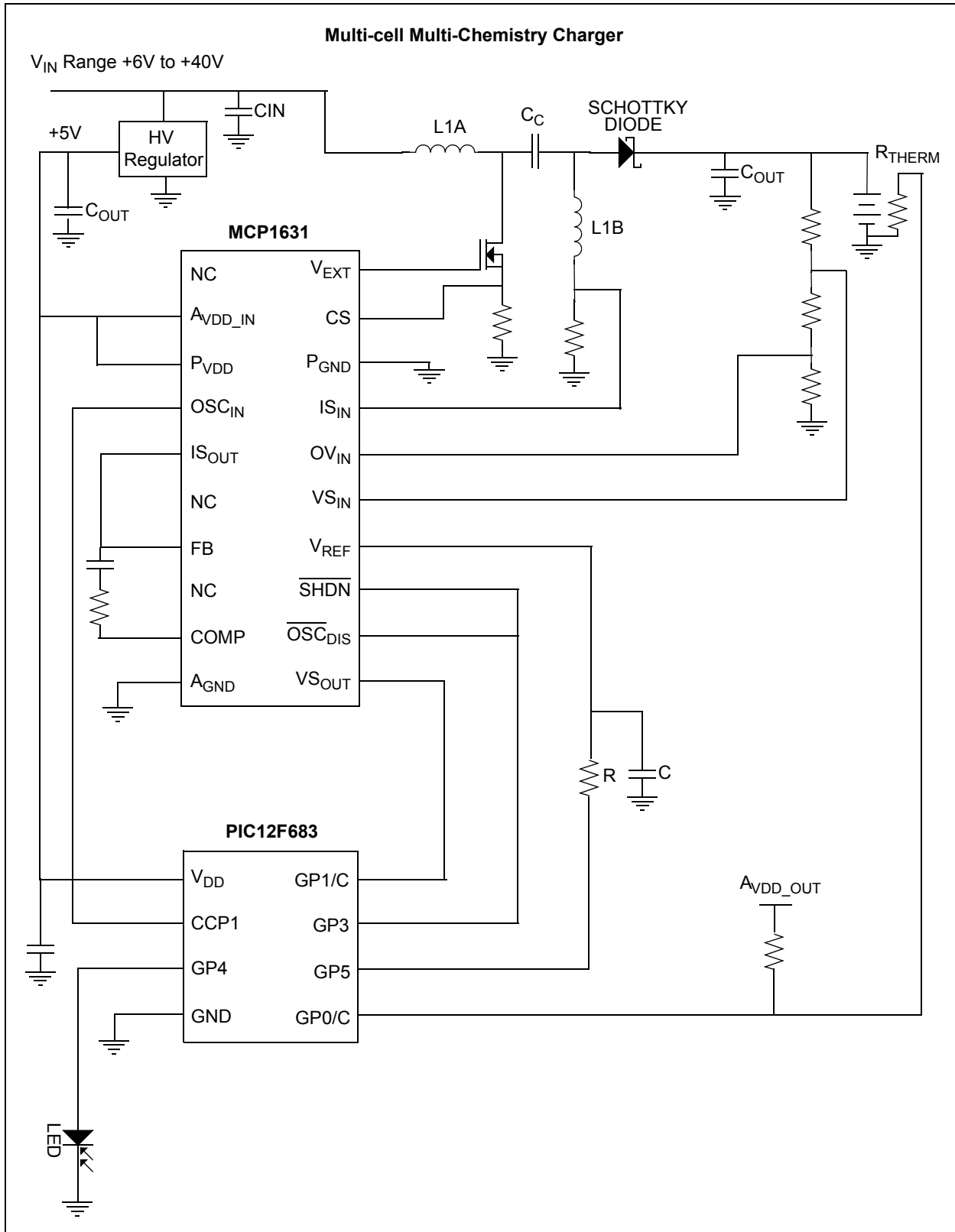

# MCP1631/HV/MCP1631V/VHV

## 6.0 PACKAGING INFORMATION

### 6.1 Package Marking Information (Not to Scale)

20-Lead 4x4 QFN (MCP1631/MCP1631V)

Example:

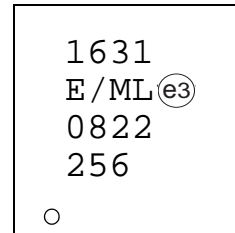
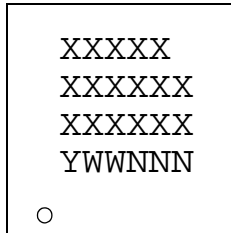

20-Lead SSOP (All Devices)

Example:

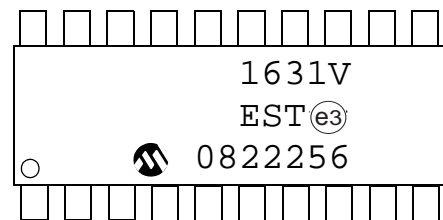
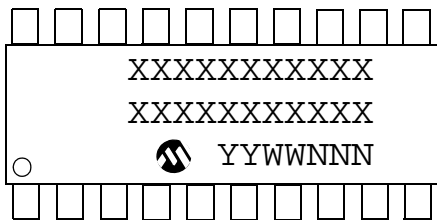

20-Lead TSSOP (All Devices)

Example:

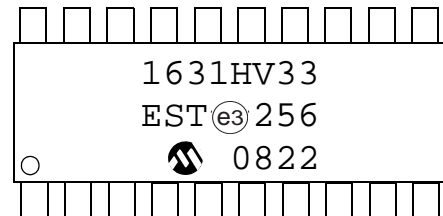
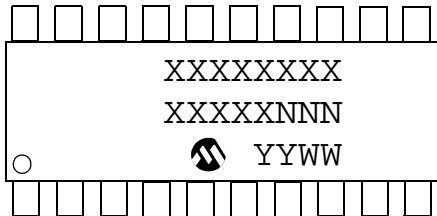

<b>Legend:</b>	XX...X	Customer-specific information
	Y	Year code (last digit of calendar year)
	YY	Year code (last 2 digits of calendar year)
	WW	Week code (week of January 1 is week '01')
	NNN	Alphanumeric traceability code
	(e3)	Pb-free JEDEC designator for Matte Tin (Sn)
	*	This package is Pb-free. The Pb-free JEDEC designator (e3) can be found on the outer packaging for this package.

**Note:** In the event the full Microchip part number cannot be marked on one line, it will be carried over to the next line, thus limiting the number of available characters for customer-specific information.

# MCP1631/HV/MCP1631V/VHV

## 20-Lead Plastic Quad Flat, No Lead Package (ML) – 4x4x0.9 mm Body [QFN]

**Note:** For the most current package drawings, please see the Microchip Packaging Specification located at <http://www.microchip.com/packageing>

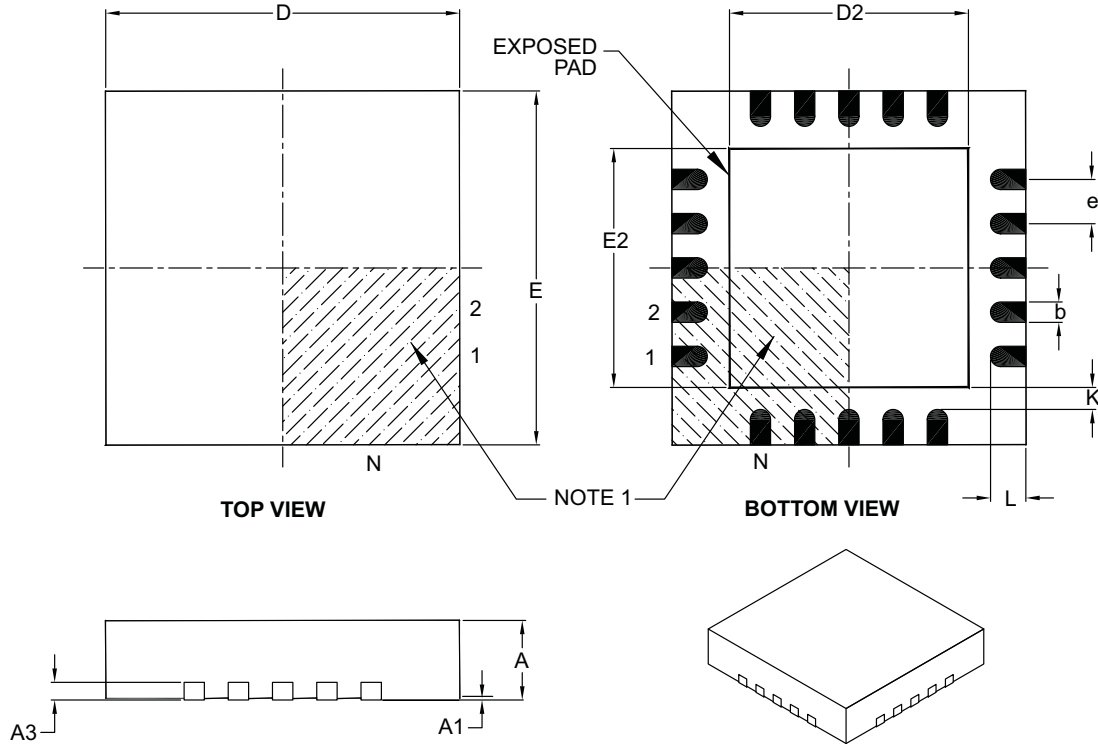

Dimension Limits	Units	MILLIMETERS		
		MIN	NOM	MAX
Number of Pins	N	20		
Pitch	e	0.50 BSC		
Overall Height	A	0.80	0.90	1.00
Standoff	A1	0.00	0.02	0.05
Contact Thickness	A3	0.20 REF		
Overall Width	E	4.00 BSC		
Exposed Pad Width	E2	2.60	2.70	2.80
Overall Length	D	4.00 BSC		
Exposed Pad Length	D2	2.60	2.70	2.80
Contact Width	b	0.18	0.25	0.30
Contact Length	L	0.30	0.40	0.50
Contact-to-Exposed Pad	K	0.20	–	–

**Notes:**

- Pin 1 visual index feature may vary, but must be located within the hatched area.
- Package is saw singulated.
- Dimensioning and tolerancing per ASME Y14.5M.

BSC: Basic Dimension. Theoretically exact value shown without tolerances.

REF: Reference Dimension, usually without tolerance, for information purposes only.

Microchip Technology Drawing C04-126B



# MCP1631/HV/MCP1631V/VHV

20-Lead Plastic Quad Flat, No Lead Package (ML) - 4x4 mm Body [QFN]  
With 0.40 mm Contact Length

**Note:** For the most current package drawings, please see the Microchip Packaging Specification located at <http://www.microchip.com/packaging>

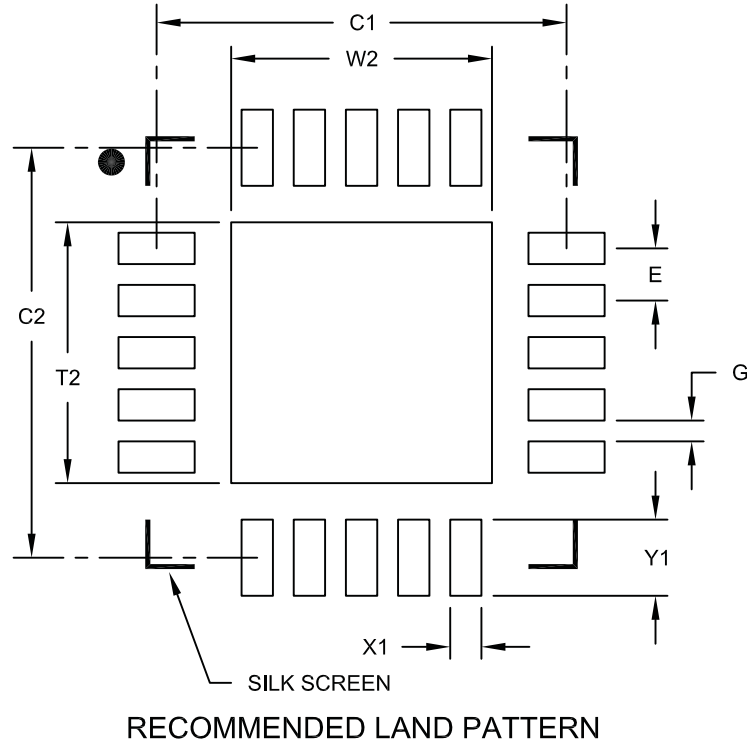

Dimension Limits	Units	MILLIMETERS		
		MIN	NOM	MAX
Contact Pitch	E	0.50 BSC		
Optional Center Pad Width	W2			2.50
Optional Center Pad Length	T2			2.50
Contact Pad Spacing	C1		3.93	
Contact Pad Spacing	C2		3.93	
Contact Pad Width	X1			0.30
Contact Pad Length	Y1			0.73
Distance Between Pads	G	0.20		

Notes:

1. Dimensioning and tolerancing per ASME Y14.5M

BSC: Basic Dimension. Theoretically exact value shown without tolerances.

Microchip Technology Drawing No. C04-2126A

# MCP1631/HV/MCP1631V/VHV

## 20-Lead Plastic Shrink Small Outline (SS) – 5.30 mm Body [SSOP]

**Note:** For the most current package drawings, please see the Microchip Packaging Specification located at <http://www.microchip.com/packaging>

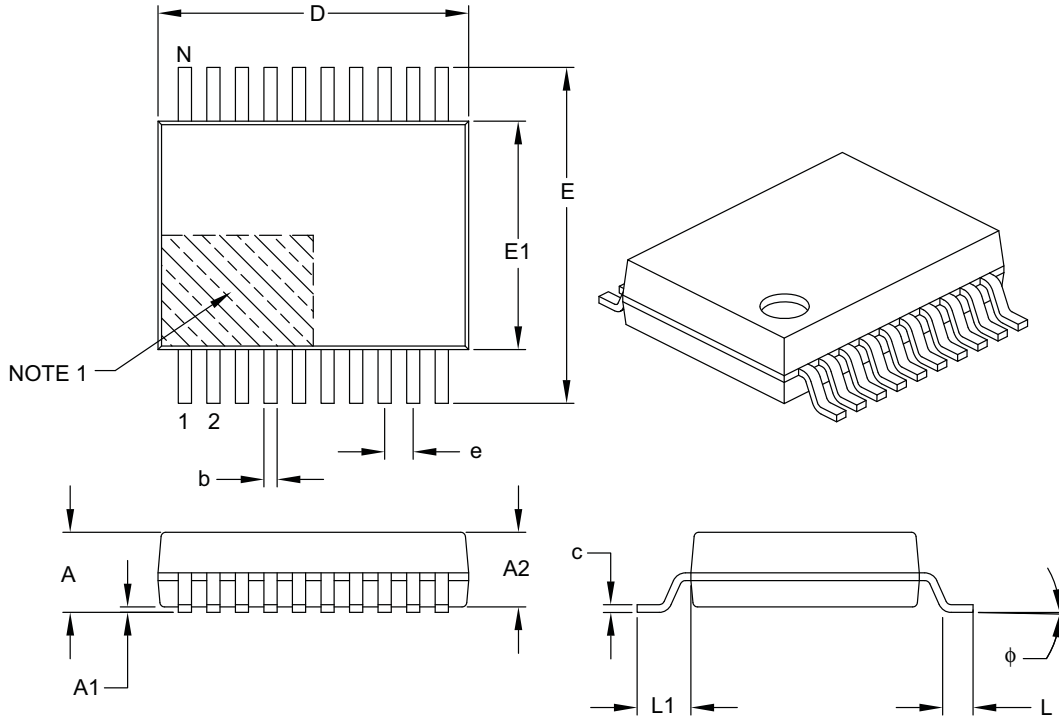

Dimension Limits	Units	MILLIMETERS		
		MIN	NOM	MAX
Number of Pins	N	20		
Pitch	e	0.65 BSC		
Overall Height	A	–	–	2.00
Molded Package Thickness	A2	1.65	1.75	1.85
Standoff	A1	0.05	–	–
Overall Width	E	7.40	7.80	8.20
Molded Package Width	E1	5.00	5.30	5.60
Overall Length	D	6.90	7.20	7.50
Foot Length	L	0.55	0.75	0.95
Footprint	L1	1.25 REF		
Lead Thickness	c	0.09	–	0.25
Foot Angle	$\phi$	0°	4°	8°
Lead Width	b	0.22	–	0.38

**Notes:**

- Pin 1 visual index feature may vary, but must be located within the hatched area.
- Dimensions D and E1 do not include mold flash or protrusions. Mold flash or protrusions shall not exceed 0.20 mm per side.
- Dimensioning and tolerancing per ASME Y14.5M.

BSC: Basic Dimension. Theoretically exact value shown without tolerances.

REF: Reference Dimension, usually without tolerance, for information purposes only.

Microchip Technology Drawing C04-072B

# MCP1631/HV/MCP1631V/VHV

## 20-Lead Plastic Thin Shrink Small Outline (ST) – 4.4 mm Body [TSSOP]

**Note:** For the most current package drawings, please see the Microchip Packaging Specification located at <http://www.microchip.com/packaging>

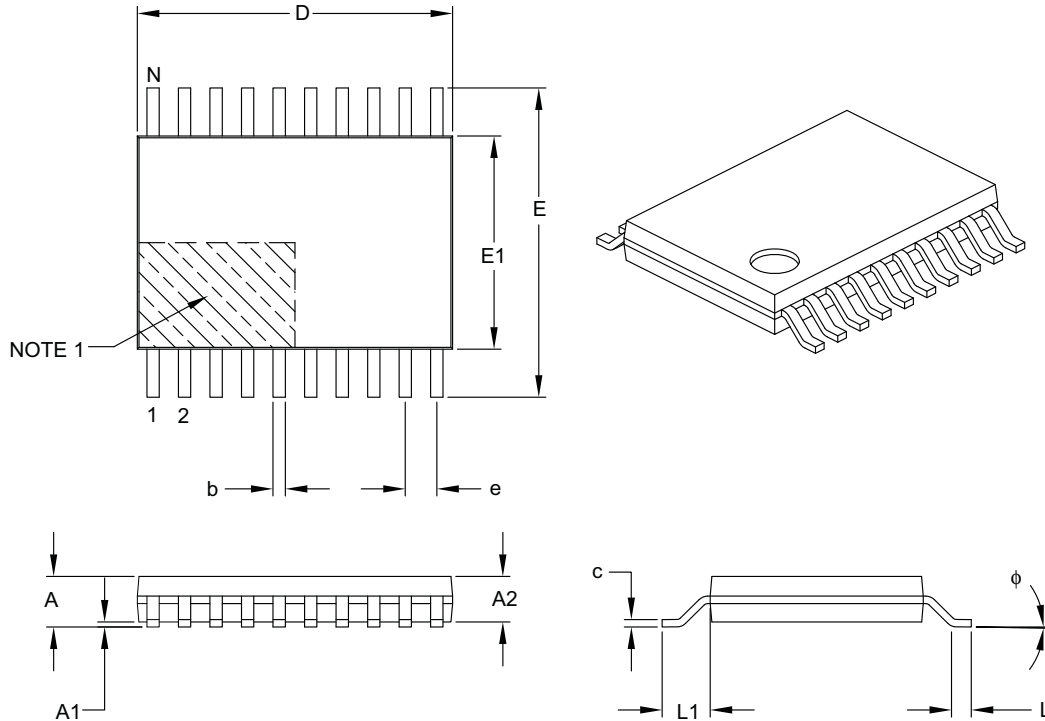

Dimension Limits	Units	MILLIMETERS		
		MIN	NOM	MAX
Number of Pins	N	20		
Pitch	e	0.65 BSC		
Overall Height	A	–	–	1.20
Molded Package Thickness	A2	0.80	1.00	1.05
Standoff	A1	0.05	–	0.15
Overall Width	E	6.40 BSC		
Molded Package Width	E1	4.30	4.40	4.50
Molded Package Length	D	6.40	6.50	6.60
Foot Length	L	0.45	0.60	0.75
Footprint	L1	1.00 REF		
Foot Angle	$\phi$	0°	–	8°
Lead Thickness	c	0.09	–	0.20
Lead Width	b	0.19	–	0.30

**Notes:**

- Pin 1 visual index feature may vary, but must be located within the hatched area.
- Dimensions D and E1 do not include mold flash or protrusions. Mold flash or protrusions shall not exceed 0.15 mm per side.
- Dimensioning and tolerancing per ASME Y14.5M.

BSC: Basic Dimension. Theoretically exact value shown without tolerances.

REF: Reference Dimension, usually without tolerance, for information purposes only.

Microchip Technology Drawing C04-088B

# MCP1631/HV/MCP1631V/VHV

---

NOTES:

## APPENDIX A: REVISION HISTORY

### Revision B (October 2008)

The following is the list of modifications:

1. **Section 2.0 “Typical Performance Curves”**, Input Offset Voltage: changed minimum, typical, maximum from -0.6, -, +0.6 to -5, -0.6, +5, respectively;
2. Updated **Section 6.0 “Packaging Information”**;
3. Updated the Product Identification System.

### Revision A (October 2007)

- Original Release of this Document.

# MCP1631/HV/MCP1631V/VHV

---

NOTES:

# MCP1631/HV/MCP1631V/VHV

## PRODUCT IDENTIFICATION SYSTEM

To order or obtain information, e.g., on pricing or delivery, refer to the factory or the listed sales office.

<b>PART NO.</b>		<b>-XXX</b>	<b>X</b>	<b>/XX</b>
<b>Device</b>		<b>Voltage Options</b>	<b>Temperature Range</b>	<b>Package</b>
Device	MCP1631:		High-Speed PWM	
	MCP1631T:		High-Speed PWM Tape and Reel	
	MCP1631HV:		High-Speed PWM	
	MCP1631HVT:		High-Speed PWM Tape and Reel	
	MCP1631HV:		High-Speed PWM	
	MCP1631HVT:		High-Speed PWM Tape and Reel	
	MCP1631VHV:		High-Speed PWM	
	MCP1631VHVT:		High-Speed PWM Tape and Reel	
Voltage options	330	=	3.3V	
	500	=	5.0V	
Temperature Range	E	=	-40°C to +125°C	
Package	ML	=	Plastic Quad Flat, No Lead (4x4x0.9), 20-lead	
	SS	=	Plastic Shrink Small Outline (5.30 mm), 20-lead	
	ST	=	Plastic Thin Shrink Small Outline (4.4 mm), 20-Lead	
	* All package offerings are Pb Free (Lead Free)			

<b>Examples:</b>	
a) MCP1631-E/ML:	High-Speed PWM, 20LD QFN package.
b) MCP1631-E/SS:	High-Speed PWM, 20LD SSOP package.
c) MCP1631-E/ST:	High-Speed PWM, 20LD TSSOP package.
a) MCP1631HV-330E/SS:	High Speed PWM, Current Mode Control, 3.3V Internal Regulator, 20LD SSOP Package.
b) MCP1631HV-500E/SS:	High Speed PWM, Current Mode Control, 5.0V Internal Regulator, 20LD SSOP Package.
c) MCP1631HV-500E/ST:	High Speed PWM, Current Mode Control, 5.0V Internal Regulator, 20LD TSSOP Package.
a) MCP1631VHVT-500E/ST:	High Speed PWM, Voltage Mode Control, 5.0V Internal Regulator, 20LD TSSOP Package.
b) MCP1631VHV-330E/SS:	High Speed PWM, Voltage Mode Control, 3.3V Internal Regulator, 20LD SSOP Package.
c) MCP1631VHV-330E/ST:	High Speed PWM, Voltage Mode Control, 3.3V Internal Regulator, 20LD TSSOP Package.

# MCP1631/HV/MCP1631V/VHV

---

NOTES:



---

**Note the following details of the code protection feature on Microchip devices:**

- Microchip products meet the specification contained in their particular Microchip Data Sheet.
- Microchip believes that its family of products is one of the most secure families of its kind on the market today, when used in the intended manner and under normal conditions.
- There are dishonest and possibly illegal methods used to breach the code protection feature. All of these methods, to our knowledge, require using the Microchip products in a manner outside the operating specifications contained in Microchip's Data Sheets. Most likely, the person doing so is engaged in theft of intellectual property.
- Microchip is willing to work with the customer who is concerned about the integrity of their code.
- Neither Microchip nor any other semiconductor manufacturer can guarantee the security of their code. Code protection does not mean that we are guaranteeing the product as “unbreakable.”

Code protection is constantly evolving. We at Microchip are committed to continuously improving the code protection features of our products. Attempts to break Microchip's code protection feature may be a violation of the Digital Millennium Copyright Act. If such acts allow unauthorized access to your software or other copyrighted work, you may have a right to sue for relief under that Act.

---

Information contained in this publication regarding device applications and the like is provided only for your convenience and may be superseded by updates. It is your responsibility to ensure that your application meets with your specifications. MICROCHIP MAKES NO REPRESENTATIONS OR WARRANTIES OF ANY KIND WHETHER EXPRESS OR IMPLIED, WRITTEN OR ORAL, STATUTORY OR OTHERWISE, RELATED TO THE INFORMATION, INCLUDING BUT NOT LIMITED TO ITS CONDITION, QUALITY, PERFORMANCE, MERCHANTABILITY OR FITNESS FOR PURPOSE. Microchip disclaims all liability arising from this information and its use. Use of Microchip devices in life support and/or safety applications is entirely at the buyer's risk, and the buyer agrees to defend, indemnify and hold harmless Microchip from any and all damages, claims, suits, or expenses resulting from such use. No licenses are conveyed, implicitly or otherwise, under any Microchip intellectual property rights.

**Trademarks**

The Microchip name and logo, the Microchip logo, Accuron, dsPIC, KEELOQ, KEELOQ logo, MPLAB, PIC, PICmicro, PICSTART, rfPIC, SmartShunt and UNI/O are registered trademarks of Microchip Technology Incorporated in the U.S.A. and other countries.

FilterLab, Linear Active Thermistor, MXDEV, MXLAB, SEEVAL, SmartSensor and The Embedded Control Solutions Company are registered trademarks of Microchip Technology Incorporated in the U.S.A.

Analog-for-the-Digital Age, Application Maestro, CodeGuard, dsPICDEM, dsPICDEM.net, dsPICworks, dsSPEAK, ECAN, ECONOMONITOR, FanSense, In-Circuit Serial Programming, ICSP, ICEPIC, Mindi, MiWi, MPASM, MPLAB Certified logo, MPLIB, MPLINK, mTouch, PICkit, PICDEM, PICDEM.net, PICtail, PIC<sup>32</sup> logo, PowerCal, PowerInfo, PowerMate, PowerTool, REAL ICE, rfLAB, Select Mode, Total Endurance, WiperLock and ZENA are trademarks of Microchip Technology Incorporated in the U.S.A. and other countries.

SQTP is a service mark of Microchip Technology Incorporated in the U.S.A.

All other trademarks mentioned herein are property of their respective companies.

© 2008, Microchip Technology Incorporated, Printed in the U.S.A., All Rights Reserved.

 Printed on recycled paper.

**QUALITY MANAGEMENT SYSTEM**  
**CERTIFIED BY DNV**  
**== ISO/TS 16949:2002 ==**

*Microchip received ISO/TS-16949:2002 certification for its worldwide headquarters, design and wafer fabrication facilities in Chandler and Tempe, Arizona; Gresham, Oregon and design centers in California and India. The Company's quality system processes and procedures are for its PIC® MCUs and dsPIC® DSCs, KEELOQ® code hopping devices, Serial EEPROMs, microperipherals, nonvolatile memory and analog products. In addition, Microchip's quality system for the design and manufacture of development systems is ISO 9001:2000 certified.*



---

---

## WORLDWIDE SALES AND SERVICE

---

---

### AMERICAS

#### Corporate Office

2355 West Chandler Blvd.  
Chandler, AZ 85224-6199  
Tel: 480-792-7200  
Fax: 480-792-7277  
Technical Support:  
<http://support.microchip.com>  
Web Address:  
[www.microchip.com](http://www.microchip.com)

#### Atlanta

Duluth, GA  
Tel: 678-957-9614  
Fax: 678-957-1455

#### Boston

Westborough, MA  
Tel: 774-760-0087  
Fax: 774-760-0088

#### Chicago

Itasca, IL  
Tel: 630-285-0071  
Fax: 630-285-0075

#### Dallas

Addison, TX  
Tel: 972-818-7423  
Fax: 972-818-2924

#### Detroit

Farmington Hills, MI  
Tel: 248-538-2250  
Fax: 248-538-2260

#### Kokomo

Kokomo, IN  
Tel: 765-864-8360  
Fax: 765-864-8387

#### Los Angeles

Mission Viejo, CA  
Tel: 949-462-9523  
Fax: 949-462-9608

#### Santa Clara

Santa Clara, CA  
Tel: 408-961-6444  
Fax: 408-961-6445

#### Toronto

Mississauga, Ontario,  
Canada  
Tel: 905-673-0699  
Fax: 905-673-6509

### ASIA/PACIFIC

#### Asia Pacific Office

Suites 3707-14, 37th Floor  
Tower 6, The Gateway  
Harbour City, Kowloon  
Hong Kong  
Tel: 852-2401-1200  
Fax: 852-2401-3431

#### Australia - Sydney

Tel: 61-2-9868-6733  
Fax: 61-2-9868-6755

#### China - Beijing

Tel: 86-10-8528-2100  
Fax: 86-10-8528-2104

#### China - Chengdu

Tel: 86-28-8665-5511  
Fax: 86-28-8665-7889

#### China - Hong Kong SAR

Tel: 852-2401-1200  
Fax: 852-2401-3431

#### China - Nanjing

Tel: 86-25-8473-2460  
Fax: 86-25-8473-2470

#### China - Qingdao

Tel: 86-532-8502-7355  
Fax: 86-532-8502-7205

#### China - Shanghai

Tel: 86-21-5407-5533  
Fax: 86-21-5407-5066

#### China - Shenyang

Tel: 86-24-2334-2829  
Fax: 86-24-2334-2393

#### China - Shenzhen

Tel: 86-755-8203-2660  
Fax: 86-755-8203-1760

#### China - Wuhan

Tel: 86-27-5980-5300  
Fax: 86-27-5980-5118

#### China - Xiamen

Tel: 86-592-2388138  
Fax: 86-592-2388130

#### China - Xian

Tel: 86-29-8833-7252  
Fax: 86-29-8833-7256

#### China - Zhuhai

Tel: 86-756-3210040  
Fax: 86-756-3210049

### ASIA/PACIFIC

#### India - Bangalore

Tel: 91-80-4182-8400  
Fax: 91-80-4182-8422

#### India - New Delhi

Tel: 91-11-4160-8631  
Fax: 91-11-4160-8632

#### India - Pune

Tel: 91-20-2566-1512  
Fax: 91-20-2566-1513

#### Japan - Yokohama

Tel: 81-45-471- 6166  
Fax: 81-45-471-6122

#### Korea - Daegu

Tel: 82-53-744-4301  
Fax: 82-53-744-4302

#### Korea - Seoul

Tel: 82-2-554-7200  
Fax: 82-2-558-5932 or  
82-2-558-5934

#### Malaysia - Kuala Lumpur

Tel: 60-3-6201-9857  
Fax: 60-3-6201-9859

#### Malaysia - Penang

Tel: 60-4-227-8870  
Fax: 60-4-227-4068

#### Philippines - Manila

Tel: 63-2-634-9065  
Fax: 63-2-634-9069

#### Singapore

Tel: 65-6334-8870  
Fax: 65-6334-8850

#### Taiwan - Hsin Chu

Tel: 886-3-572-9526  
Fax: 886-3-572-6459

#### Taiwan - Kaohsiung

Tel: 886-7-536-4818  
Fax: 886-7-536-4803

#### Taiwan - Taipei

Tel: 886-2-2500-6610  
Fax: 886-2-2508-0102

#### Thailand - Bangkok

Tel: 66-2-694-1351  
Fax: 66-2-694-1350

### EUROPE

#### Austria - Wels

Tel: 43-7242-2244-39  
Fax: 43-7242-2244-393

#### Denmark - Copenhagen

Tel: 45-4450-2828  
Fax: 45-4485-2829

#### France - Paris

Tel: 33-1-69-53-63-20  
Fax: 33-1-69-30-90-79

#### Germany - Munich

Tel: 49-89-627-144-0  
Fax: 49-89-627-144-44

#### Italy - Milan

Tel: 39-0331-742611  
Fax: 39-0331-466781

#### Netherlands - Drunen

Tel: 31-416-690399  
Fax: 31-416-690340

#### Spain - Madrid

Tel: 34-91-708-08-90  
Fax: 34-91-708-08-91

#### UK - Wokingham

Tel: 44-118-921-5869  
Fax: 44-118-921-5820