



FXLA108

Low-Voltage Dual-Supply 8-Bit Voltage Translator with Configurable Voltage Supplies and Signal Levels, 3-State Outputs, and Auto Direction Sensing

Features

- Bi-Directional Interface between Two Levels: from 1.1V to 3.6V
- Fully Configurable: Inputs and Outputs Track V_{CC}
- Non-Preferential Power-Up; Either V_{CC} May Be Powered Up First
- Outputs Remain in 3-State Until Active V_{CC} Level is Reached
- Outputs Switch to 3-State if Either V_{CC} is at GND
- Power-Off Protection
- Bus-Hold on Data Inputs Eliminates the Need for Pull-Up Resistors
- Control Input (/OE) Referenced to V_{CCA} Voltage
- Packaged in 20-Terminal DQFN (2.5mm x 4.5mm)
- Direction Control Not Necessary
- 100Mbps Throughput when Translating Between 1.8V and 2.5V
- ESD Protection Exceeds:
 - 8kV HBM (per JESD22-A114 & Mil Std 883e 3015.7)
 - 2kV CDM (per ESD STM 5.3)

Description

The FXLA108 is a configurable dual-voltage supply translator for both uni-directional and bi-directional voltage translation between two logic levels. The device allows translation between voltages as high as 3.6V to as low as 1.1V. The A port tracks the V_{CCA} level and the B port tracks the V_{CCB} level. This allows for bi-directional voltage translation over a variety of voltage levels: 1.2V, 1.5V, 1.8V, 2.5V, and 3.3V.

The device remains in three-state until both V_{CCs} reach active levels, allowing either V_{CC} to be powered up first. Internal power-down control circuits place the device in 3-state if either V_{CC} is removed.

The /OE input, when HIGH, disables both the A and B ports by placing them in a 3-state condition. The /OE input is supplied by V_{CCA} .

The FXLA108 supports bi-directional translation without the need for a direction control pin. The two ports of the device have auto-direction sense capability. Either port may sense an input signal and transfer it as an output signal to the other port.

Applications

- Laptops, Notebooks,
- Routers, Switches

Ordering Information

Part Number	Operating Temperature Range	Eco Status	Package	Packing Method
FXLA108BQX	-40 to 85°C	Green	20-Terminal DQFN 2.5mm x 4.5mm Package	Tape and Reel

For Fairchild's definition of "green" Eco Status, please visit: http://www.fairchildsemi.com/company/green/rohs_green.html.

Pin Configuration

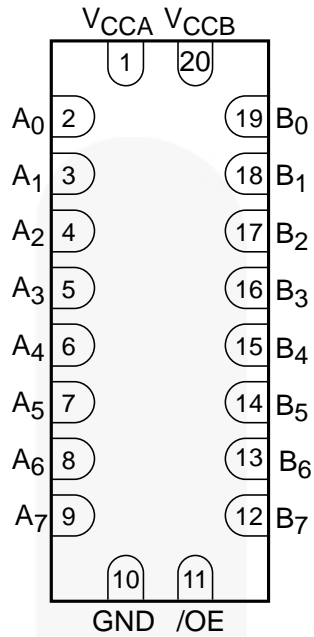

Figure 1. Pin Configuration (Top Through View)

Pin Definitions

Pin #	Name	Description
1	V_{CCA}	A-Side Power Supply
2	A_0	A-Side Inputs or 3-State Outputs
3	A_1	A-Side Inputs or 3-State Outputs
4	A_2	A-Side Inputs or 3-State Outputs
5	A_3	A-Side Inputs or 3-State Outputs
6	A_4	A-Side Inputs or 3-State Outputs
7	A_5	A-Side Inputs or 3-State Outputs
8	A_6	A-Side Inputs or 3-State Outputs
9	A_7	A-Side Inputs or 3-State Outputs
10	GND	Ground
11	$/OE$	Output Enable Input
12	B_7	B-Side Inputs or 3-State Outputs
13	B_6	B-Side Inputs or 3-State Outputs
14	B_5	B-Side Inputs or 3-State Outputs
15	B_4	B-Side Inputs or 3-State Outputs
16	B_3	B-Side Inputs or 3-State Outputs
17	B_2	B-Side Inputs or 3-State Outputs
18	B_1	B-Side Inputs or 3-State Outputs
19	B_0	B-Side Inputs or 3-State Outputs
20	V_{CCB}	B-Side Power Supply

Functional Diagram

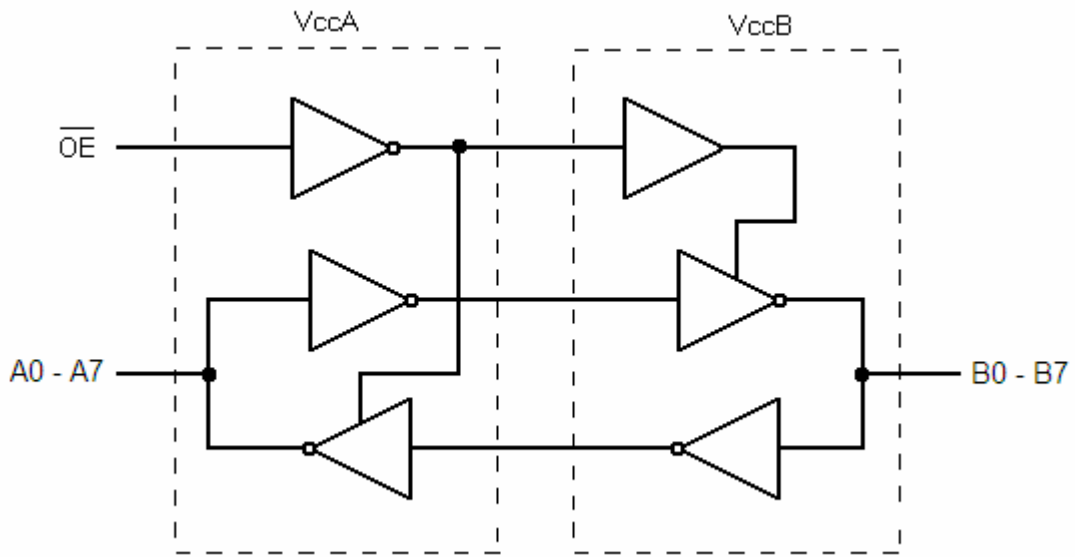

Figure 2. Functional Diagram

Functional Table

Control	Outputs
\overline{OE}	
LOW Logic Level	Normal Operation
HIGH Logic Level	3-State

Absolute Maximum Ratings

Stresses exceeding the absolute maximum ratings may damage the device. The device may not function or be operable above the recommended operating conditions and stressing the parts to these levels is not recommended. In addition, extended exposure to stresses above the recommended operating conditions may affect device reliability. The absolute maximum ratings are stress ratings only.

Symbol	Parameter	Conditions	Min.	Max.	Unit
V_{CC}	Supply Voltage	V_{CCA}	-0.5	4.6	V
		V_{CCB}	-0.5	4.6	
V_I	DC Input Voltage	I/O Ports A and B	-0.5	4.6	V
		Control Input (/OE)	-0.5	4.6	
V_O	Output Voltage ⁽²⁾	Output 3-State	-0.5	4.6	V
		Output Active (A_n)	-0.5	$V_{CCA} + 0.5$	
		Output Active (B_n)	-0.5	$V_{CCB} + 0.5$	
I_{IK}	DC Input Diode Current	$V_I < 0V$		-50	mA
I_{OK}	DC Output Diode Current	$V_O < 0V$		-50	mA
		$V_O > V_{CC}$		+50	
I_{OH}/I_{OL}	DC Output Source/Sink Current		-50	+50	mA
I_{CC}	DC V_{CC} or Ground Current (per Supply Pin)			±100	mA
T_{STG}	Storage Temperature Range		-65	+150	°C

Notes:

- I_O absolute maximum ratings must be observed.
- All unused inputs and input/outputs must be held at V_{CCi} or GND.

Recommended Operating Conditions

The Recommended Operating Conditions table defines the conditions for actual device operation. Recommended operating conditions are specified to ensure optimal performance to the datasheet specifications. Fairchild does not recommend exceeding them or designing to Absolute Maximum Ratings.

Symbol	Parameter	Conditions	Min.	Max.	Unit
V_{CC}	Power Supply	Operating V_{CCA} or V_{CCB}	1.1	3.6	V
V_{IN}	Input Voltage	Ports A and B	0	3.6	V
		Control Input (/OE)	0	V_{CCA}	V
T_A	Operating Temperature, Free Air		-40	+85	°C
dt/dV	Minimum Input Edge Rate	$V_{CCA/B} = 1.1$ to $3.6V$		10	ns/V

Power-Up/Power-Down Sequence

FXL translators offer an advantage in that either V_{CC} may be powered up first. This benefit derives from the chip design. When either V_{CC} is at 0V, outputs are in a high-impedance state. The control input (/OE) is designed to track the V_{CCA} supply. A pull-up resistor tying /OE to V_{CCA} should be used to ensure that bus contention, excessive currents, or oscillations do not occur during power-up or power-down. The size of the pull-up resistor is based upon the current-sinking capability of the device driving the /OE pin.

The recommended power-up sequence is:

1. Apply power to the first V_{CC} .
2. Apply power to the second V_{CC} .
3. Drive the /OE input LOW to enable the device.

The recommended power-down sequence is:

1. Drive /OE input HIGH to disable the device.
2. Remove power from either V_{CC} .
3. Remove power from other V_{CC} .

DC Electrical Characteristics

T_A = -40 to 85°C.

Symbol	Parameter	Conditions	V _{CCA} (V)	V _{CCB} (V)	Min.	Typ.	Max.	Units
V _{IHA}	High-Level Input Voltage	Data Inputs A _n Control Pin /OE	2.70 to 3.60	1.10 to 3.60	2.00			V
			2.30 to 2.70		1.60			
			1.65 to 2.30		.65xV _{CCA}			
			1.40 to 1.65		.65xV _{CCA}			
			1.10 to 1.40		.90xV _{CCA}			
V _{IHB}	High-Level Input Voltage	Data Inputs B _n	2.70 to 3.60	1.10 to 3.60	2.00			V
			2.30 to 2.70		1.60			
			1.65 to 2.30		.65xV _{CCB}			
			1.40 to 1.65		.65xV _{CCB}			
			1.10 to 1.40		.90xV _{CCB}			
V _{IILA}	Low-Level Input Voltage	Data Inputs A _n Control Pin /OE	2.70 to 3.60	1.10 to 3.60			.80	V
			2.30 to 2.70				.70	
			1.65 to 2.30				.35xV _{CCA}	
			1.40 to 1.65				.35xV _{CCA}	
			1.10 to 1.40				.10xV _{CCA}	
V _{IILB}	Low-Level Input Voltage	Data Inputs B _n	2.70 to 3.60	1.10 to 3.60			.80	V
			2.30 to 2.70				.70	
			1.65 to 2.30				.35xV _{CCB}	
			1.40 to 1.65				.35xV _{CCB}	
			1.10 to 1.40				.10xV _{CCB}	
V _{OHA}	High-Level Output Voltage ⁽³⁾	I _{OH} = -4μA	1.10 to 3.60	1.10 to 3.60	V _{CCA} - .40			V
V _{OHB}		I _{OH} = -4μA	1.10 to 3.60	1.10 to 3.60	V _{CCB} - .40			
V _{OLA}	Low-Level Output Voltage ⁽³⁾	I _{OL} = 4μA	1.10 to 3.60	1.10 to 3.60			.4	V
V _{OLB}		I _{OL} = 4μA	1.10 to 3.60	1.10 to 3.60			.4	
I _{I(HOLD)}	Bus-Hold Input Minimum Drive Current	V _{IN} = 0.80V	3.00	3.00	75.0			μA
		V _{IN} = 2.00V	3.00	3.00	-75.0			
		V _{IN} = 0.7V	2.30	2.30	45.0			
		V _{IN} = 1.60V	2.30	2.30	-45.0			
		V _{IN} = 0.57V	1.65	1.65	25.0			
		V _{IN} = 1.07V	1.65	1.65	-25.0			
		V _{IN} = 0.49V	1.40	1.40	11.0			
		V _{IN} = 0.91V	1.40	1.40	-11.0			
		V _{IN} = 0.11V	1.10	1.10		4.0		
		V _{IN} = 0.99V	1.10	1.10		-4.0		

Continued on following page...

DC Electrical Characteristics (Continued)

T_A = -40 to 85°C.

Symbol	Parameter	Conditions	V _{CCA} (V)	V _{CCB} (V)	Min.	Max.	Units
I _{I(ODH)}	Bus-Hold Input Overdrive High Current ⁽⁴⁾	Data Inputs A _n , B _n	3.60	3.60	450.00		μA
			2.70	2.70	300.00		
			1.95	1.95	200.00		
			1.60	1.60	120.00		
			1.40	1.40	80.00		
I _{I(ODL)}	Bus-Hold Input Overdrive Low Current ⁽⁵⁾	Data Inputs A _n , B _n	3.60	3.60	-450.00		μA
			2.70	2.70	-300.00		
			1.95	1.95	-200.00		
			1.60	1.60	-120.00		
			1.40	1.40	-80.00		
I _I	Input Leakage Current	Control Inputs /OE, V _I =V _{CCA} or GND	1.10 to 3.60	3.60		±1.0	μA
I _{OFF}	Power-Off Leakage Current	A _n V _O =0V to 3.6V	0	3.6		±2.0	μA
		B _n V _O =0V to 3.6V	3.60	0		±2.0	
I _{OZ}	3-State Output Leakage	A _n , B _n V _O =0V or 3.6V, /OE=V _{IH}	3.6	3.60		±5.0	μA
		A _n V _O =0V or 3.6V, /OE=GND	3.60	0		±5.0	
		B _n V _O =0V or 3.6V, /OE=GND	0	3.60		±5.0	
I _{CCA/B}	Quiescent Supply Current ^(6,7)	V _I =V _{CCI} or GND; I _O =0, /OE=GND	1.10 to 3.60	1.10 to 3.60		10.0	μA
I _{CCZ}		V _I =V _{CCI} or GND; I _O =0, /OE=V _{IH}	1.10 to 3.60	1.10 to 3.60		10.0	μA
I _{CCA}	Quiescent Supply Current	V _I =V _{CCB} or GND; I _O =0 B-to-A Direction, /OE=GND	0	1.10 to 3.60		-10.0	μA
		V _I =V _{CCA} or GND; I _O =0 A-to-B Direction	1.10 to 3.60	0		10.0	
I _{CCB}	Quiescent Supply Current	V _I =V _{CCA} or GND; I _O =0, A-to-B Direction, /OE=GND	1.10 to 3.60	0		-10.0	μA
		V _I =V _{CCB} or GND; I _O =0 B-to-A Direction	0	1.10 to 3.60		10.0	

Notes:

3. This is the output voltage for static conditions. Dynamic drive specifications are given in the Dynamic Output Electrical Characteristics table.
4. An external drive must source at least the specified current to switch LOW-to-HIGH.
5. An external drive must source at least the specified current to switch HIGH-to-LOW.
6. V_{CCI} is the V_{CC} associated with the input side.
7. Reflects current per supply, V_{CCA} or V_{CCB}.

Dynamic Output Electrical Characteristic

A Port (A_n)

Output Load: C_L=15pF, R_L ≥ MΩ (C_{I/O}=4pF), T_A=-40 to 85°C

Symbol	Parameter	V _{CCA} =3.0V to 3.6V		V _{CCA} =2.3V to 2.7V		V _{CCA} =1.65V to 1.95V		V _{CCA} =1.4V to 1.6V		V _{CCA} =1.1V to 1.3V	Units
		Typ.	Max.	Typ.	Max.	Typ.	Max.	Typ.	Max.	Typ.	
t _{rise}	Output Rise Time A Port ⁽⁹⁾		3.0		3.5		4.0		5.0	7.5	ns
t _{fall}	Output Fall Time A Port ⁽¹⁰⁾		3.0		3.5		4.0		5.0	7.5	ns
I _{OHD}	Dynamic Output Current High ⁽⁹⁾	-11.4		-7.5		-4.7		-3.2		-1.7	mA
I _{OLD}	Dynamic Output Current Low ⁽¹⁰⁾	+11.4		+7.5		+4.7		+3.2		+1.7	mA

B Port (B_n)

Output Load: C_L=15pF, R_L ≥ MΩ (C_{I/O}=5pF), T_A=-40 to 85°C

Symbol	Parameter	V _{CCB} =3.0V to 3.6V		V _{CCB} =2.3V to 2.7V		V _{CCB} =1.65V to 1.95V		V _{CCB} =1.4V to 1.6V		V _{CCB} =1.1V to 1.3V	Units
		Typ.	Max.	Typ.	Max.	Typ.	Max.	Typ.	Max.	Typ.	
t _{rise}	Output Rise Time B Port ⁽⁹⁾		3.0		3.5		4.0		5.0	7.5	ns
t _{fall}	Output Fall Time B Port ⁽¹⁰⁾		3.0		3.5		4.0		5.0	7.5	ns
I _{OHD}	Dynamic Output Current High ⁽⁹⁾	-12.0		-7.9		-5.0		-3.4		-1.8	mA
I _{OLD}	Dynamic Output Current Low ⁽¹⁰⁾	+12.0		+7.9		+5.0		+3.4		+1.8	mA

Notes:

8. Dynamic output characteristics are guaranteed, but not tested.
9. See Figure 7.
10. See Figure 8.

AC Characteristics

$V_{CCA} = 3.0V$ to $3.6V$, $T_A = -40$ to $85^\circ C$

Symbol	Parameter	$V_{CCB}=3.0V$ to $3.6V$		$V_{CCB}=2.3V$ to $2.7V$		$V_{CCB}=1.65V$ to $1.95V$		$V_{CCB}=1.4V$ to $1.6V$		$V_{CCB}=1.1V$ to $1.3V$	Units
		Min.	Max.	Min.	Max.	Min.	Max.	Min.	Max.	Typ.	
t_{PLH}, t_{PHL}	A to B	0.2	4.0	0.3	4.2	0.5	5.4	0.6	6.8	6.9	ns
	B to A	0.2	4.0	0.2	4.1	0.3	5.0	0.5	6.0	4.5	ns
t_{PZL}, t_{PZH}	/OE to A, /OE to B		1.7		1.7		1.7		1.7	1.7	μs
t_{SKEW}	A Port, B Port ⁽¹¹⁾		0.5		0.5		0.5		1.0	1.0	ns

$V_{CCA} = 2.3V$ to $2.7V$, $T_A = -40$ to $85^\circ C$

Symbol	Parameter	$V_{CCB}=3.0V$ to $3.6V$		$V_{CCB}=2.3V$ to $2.7V$		$V_{CCB}=1.65V$ to $1.95V$		$V_{CCB}=1.4V$ to $1.6V$		$V_{CCB}=1.1V$ to $1.3V$	Units
		Min.	Max.	Min.	Max.	Min.	Max.	Min.	Max.	Typ.	
t_{PLH}, t_{PHL}	A to B	0.2	4.1	0.4	4.5	0.5	5.6	0.8	6.9	7.0	ns
	B to A	0.3	4.2	0.4	4.5	0.5	5.5	0.5	6.5	4.8	ns
t_{PZL}, t_{PZH}	/OE to A, /OE to B		1.7		1.7		1.7		1.7	1.7	μs
t_{SKEW}	A Port, B Port ⁽¹¹⁾		0.5		0.5		0.5		1.0	1.0	ns

$V_{CCA} = 1.65V$ to $1.95V$, $T_A = -40$ to $85^\circ C$

Symbol	Parameter	$V_{CCB}=3.0V$ to $3.6V$		$V_{CCB}=2.3V$ to $2.7V$		$V_{CCB}=1.65V$ to $1.95V$		$V_{CCB}=1.4V$ to $1.6V$		$V_{CCB}=1.1V$ to $1.3V$	Units
		Min.	Max.	Min.	Max.	Min.	Max.	Min.	Max.	Typ.	
t_{PLH}, t_{PHL}	A to B	0.3	5.0	0.5	5.5	0.8	6.7	0.9	7.5	7.5	ns
	B to A	0.5	5.4	0.5	5.6	0.8	6.7	1.0	7.0	5.4	ns
t_{PZL}, t_{PZH}	/OE to A, /OE to B		1.7		1.7		1.7		1.7	1.7	μs
t_{SKEW}	A Port, B Port ⁽¹¹⁾		0.5		0.5		0.5		1.0	1.0	ns

Note:

11. Skew is the variation of propagation delay between output signals and applies only to output signals on the same port A_n or B_n) and switching with the same polarity (LOW-to-HIGH or HIGH-to-LOW) (see Figure 10). Skew is guaranteed, but not tested.

AC Characteristics (Continued)

$V_{CCA} = 1.4V$ to $1.6V$, $T_A = -40$ to $85^\circ C$

Symbol	Parameter	$V_{CCB}=3.0V$ to $3.6V$		$V_{CCB}=2.3V$ to $2.7V$		$V_{CCB}=1.65V$ to $1.95V$		$V_{CCB}=1.4V$ to $1.6V$		$V_{CCB}=1.1V$ to $1.3V$	Units
		Min.	Max.	Min.	Max.	Min.	Max.	Min.	Max.	Typ.	
t_{PLH}, t_{PHL}	A to B	0.5	6.0	0.5	6.5	1.0	7.0	1.0	8.5	7.9	ns
	B to A	0.6	6.8	0.8	6.9	0.9	7.5	1.0	8.5	6.1	ns
t_{PZL}, t_{PZH}	/OE to A, /OE to B		1.7		1.7		1.7		1.7	1.7	μs
t_{SKEW}	A Port, B Port ⁽¹²⁾		1.0		1.0		1.0		1.0	1.0	ns

$V_{CCA} = 1.1V$ to $1.3V$, $T_A = -40$ to $85^\circ C$

Symbol	Parameter	$V_{CCB}=3.0V$ to $3.6V$	$V_{CCB}=2.3V$ to $2.7V$	$V_{CCB}=1.65V$ to $1.95V$	$V_{CCB}=1.4V$ to $1.6V$	$V_{CCB}=1.1V$ to $1.3V$	Units
		Typ.	Typ.	Typ.	Typ.	Typ.	
t_{PLH}, t_{PHL}	A to B	4.6	4.8	5.4	6.2	9.2	ns
	B to A	6.8	7.0	7.4	7.8	9.1	ns
t_{PZL}, t_{PZH}	/OE to A, /OE to B	1.7	1.7	1.7	1.7	1.7	μs
t_{SKEW}	A Port, B Port ⁽¹²⁾	1.0	1.0	1.0	1.0	1.0	ns

Note:

12. Skew is the variation of propagation delay between output signals and applies only to output signals on the same port (A_n or B_n) and switching with the same polarity (LOW-to-HIGH or HIGH-to-LOW) (see Figure 10). Skew is guaranteed, but not tested.

Maximum Data Rate^(13, 14)

$T_A = -40$ to 85°C .

V_{CCA}	$V_{CCB}=3.0\text{V}$ to 3.6V	$V_{CCB}=2.3\text{V}$ to 2.7V	$V_{CCB}=1.65\text{V}$ to 1.95V	$V_{CCB}=1.4\text{V}$ to 1.6V	$V_{CCB}=1.1\text{V}$ to 1.3V	Units
	Min.	Min.	Min.	Min.	Typ.	
$V_{CCA}=3.00\text{V}$ to 3.60V	140	120	100	80	40	Mbps
$V_{CCA}=2.30\text{V}$ to 2.70V	120	120	100	80	40	Mbps
$V_{CCA}=1.65\text{V}$ to 1.95V	100	100	80	60	40	Mbps
$V_{CCA}=1.40\text{V}$ to 1.60V	80	80	60	60	40	Mbps
$V_{CCA}=1.10\text{V}$ to 1.30V	Typ.	Typ.	Typ.	Typ.	Typ.	
	40	40	40	40	40	Mbps

Notes:

13. Maximum data rate is guaranteed, but not tested.

14. Maximum data rate is specified in megabits per second (see Figure 9). It is equivalent to two times the F-toggle frequency, specified in megahertz. For example, 100Mbps is equivalent to 50MHz.

Capacitance

Symbol	Parameter	Conditions	$T_A = +25^\circ\text{C}$ Typical	Units	
C_{IN}	Input Capacitance Control Pin (/OE)	$V_{CCA}=V_{CCB}=\text{GND}$	3	pF	
$C_{I/O}$	Input/Output Capacitance	$V_{CCA}=V_{CCB}=3.3\text{V}$, /OE= V_{CCA}	A_n	4	pF
			B_n	5	
C_{pd}	Power Dissipation Capacitance	$V_{CCA}=V_{CCB}=3.3\text{V}$, $V_I=0\text{V}$ or V_{CC} , $f=10\text{MHz}$	25	pF	

Test Diagrams

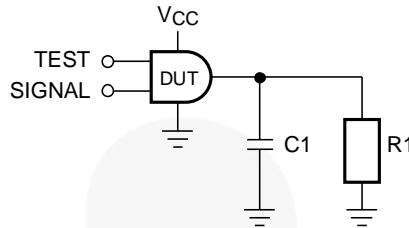

Figure 3. Test Circuit

Table 1. AC Test Conditions

Test	Input Signal	Output Enable Control
t_{PLH} , t_{PHL}	Data Pulses	0V
t_{PZL}	0V	HIGH to LOW Switch
t_{PZH}	V_{CCI}	HIGH to LOW Switch

Table 2. AC Load

V_{CCO}	C1	R1
$1.2V \pm 0.1V$	15pF	1M Ω
$1.5V \pm 0.1V$	15pF	1M Ω
$1.8V \pm 0.15V$	15pF	1M Ω
$2.5V \pm 0.2V$	15pF	1M Ω
$3.3V \pm 0.3V$	15pF	1M Ω

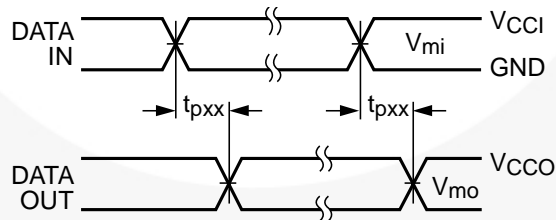

Figure 4. Waveform for Inverting and Non-Inverting Functions

Notes:

- 15. Input $t_R = t_F = 2.0ns$, 10% to 90%.
- 16. Input $t_R = t_F = 2.5ns$, 10% to 90%, at $V_I = 3.0V$ to $3.6V$ only.

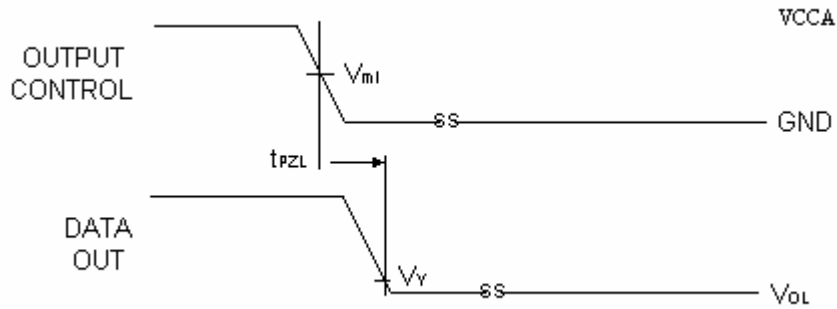

Figure 5. 3-State Output Low Enable Time for Low Voltage Logic

Notes:

- 17. Input $t_R = t_F = 2.0\text{ns}$, 10% to 90%.
- 18. Input $t_R = t_F = 2.5\text{ns}$, 10% to 90%, at $V_I = 3.0\text{V}$ to 3.6V only.

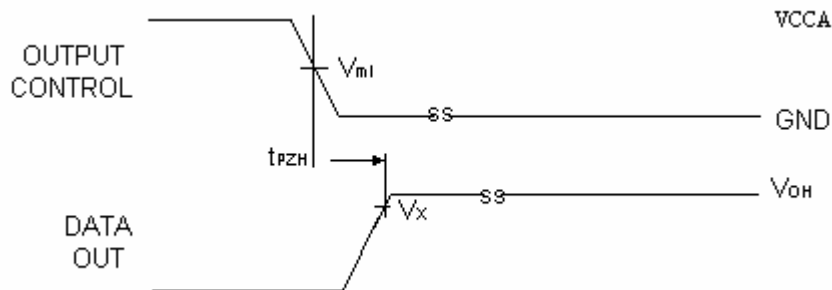

Figure 6. 3-State Output High Enable Time for Low Voltage Logic

Notes:

- 19. Input $t_R = t_F = 2.0\text{ns}$, 10% to 90%.
- 20. Input $t_R = t_F = 2.5\text{ns}$, 10% to 90%, at $V_I = 3.0\text{V}$ to 3.6V only.

Table 3. Test Measure Points

Symbol	V_{DD}
$V_{MI}^{(21)}$	$V_{CCI} / 2$
V_{MO}	$V_{CCO} / 2$
V_X	$0.9 \times V_{CCO}$
V_Y	$0.1 \times V_{CCO}$

Note:

- 21. $V_{CCI} = V_{CCA}$ for control pin /OE or $V_{MI} = (V_{CCA} / 2)$.

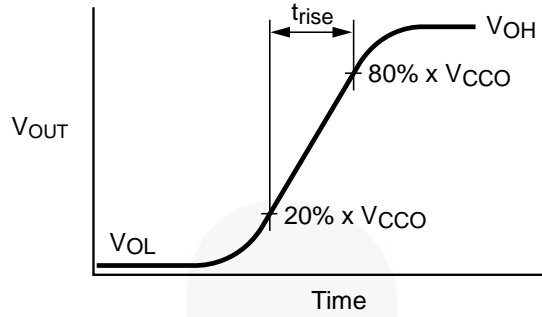

$$I_{OHD} \approx (C_L + C_{I/O}) \times \frac{\Delta V_{OUT}}{\Delta t} = (C_L + C_{I/O}) \times \frac{(20\% - 80\%) \cdot V_{CCO}}{t_{RISE}}$$

Figure 7. Active Output Rise Time and Dynamic Output Current High

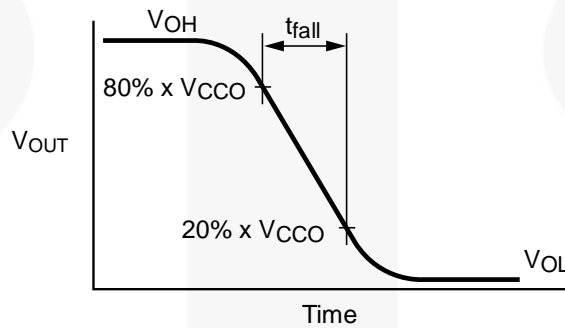

$$I_{OLD} \approx (C_L + C_{I/O}) \times \frac{\Delta V_{OUT}}{\Delta t} = (C_L + C_{I/O}) \times \frac{(80\% - 20\%) \cdot V_{CCO}}{t_{FALL}}$$

Figure 8. Active Output Fall Time and Dynamic Output Current Low

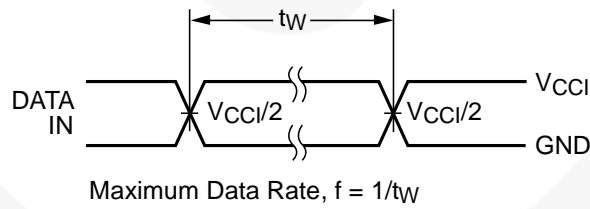

Figure 9. Maximum Data Rate

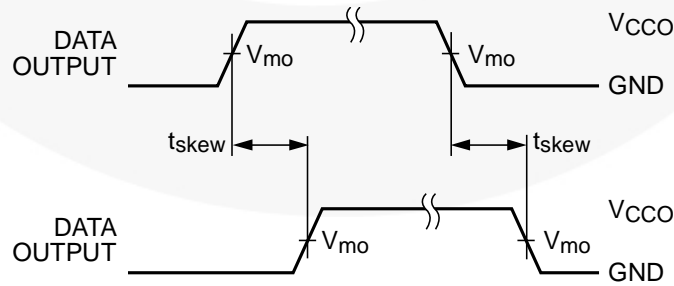
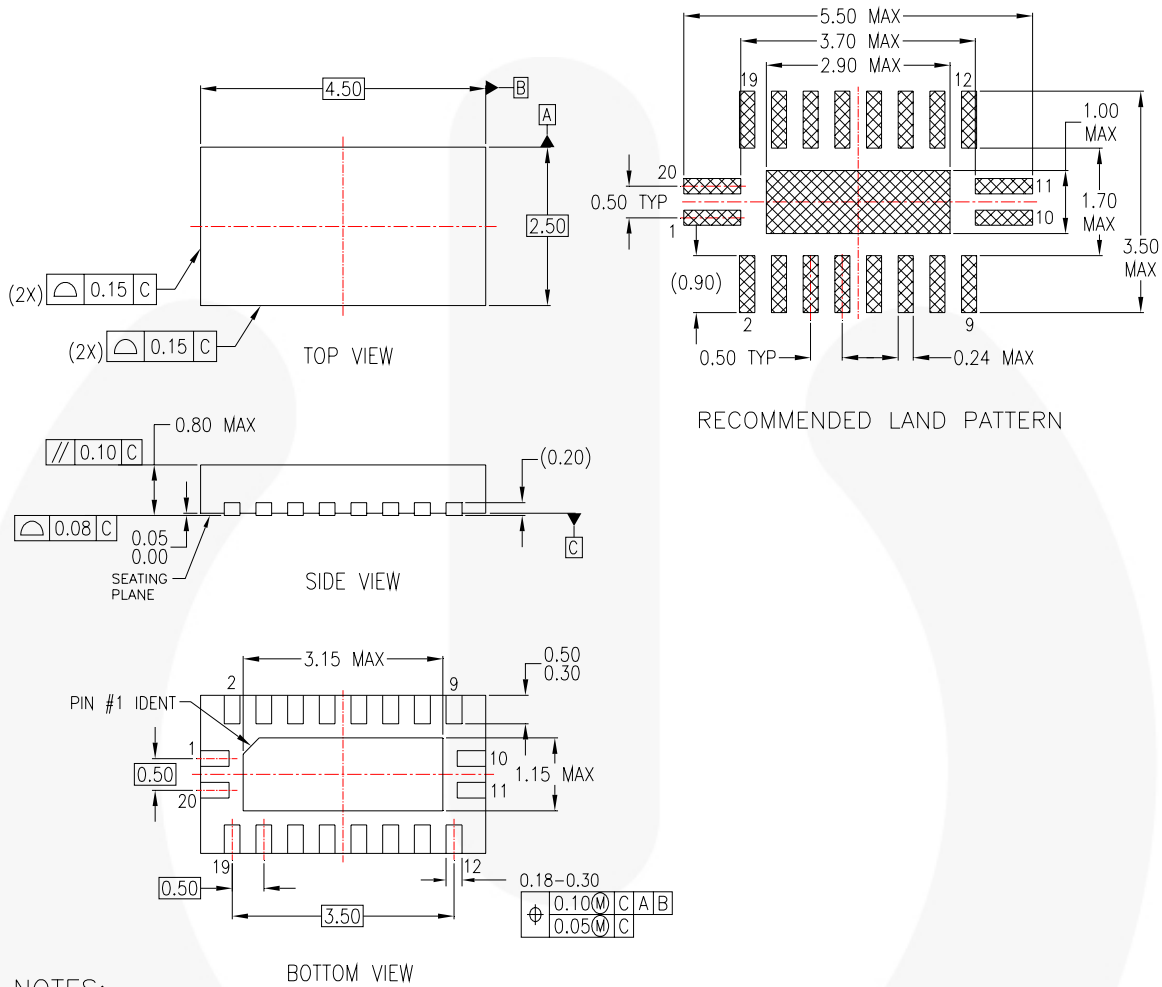

Figure 10. Output Skew Time

Note:

22. $t_{SKEW} = (t_{pHLmax} - t_{pHLmin})$ OR $(t_{pLHmax} - t_{pLHmin})$

Physical Dimensions



NOTES:

- A. CONFORMS TO JEDEC REGISTRATION MO-241, VARIATION AC
- B. DIMENSIONS ARE IN MILLIMETERS.
- C. DIMENSIONS AND TOLERANCES PER ASME Y14.5M, 1994

MLP20BrevA

Figure 11. 20-Terminal DQFN 2.5mm x 4.5mm Package





Package drawings are provided as a service to customers considering Fairchild components. Drawings may change in any manner without notice. Please note the revision and/or date on the drawing and contact a Fairchild Semiconductor representative to verify or obtain the most recent revision. Package specifications do not expand the terms of Fairchild's worldwide terms and conditions, specifically the warranty therein, which covers Fairchild products.

Always visit Fairchild Semiconductor's online packaging area for the most recent package drawings:
<http://www.fairchildsemi.com/packaging/>



TRADEMARKS

The following includes registered and unregistered trademarks and service marks, owned by Fairchild Semiconductor and/or its global subsidiaries, and is not intended to be an exhaustive list of all such trademarks.

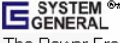
- | | | | |
|---|---|---|---|
| Build it Now™ | FRFET® | Programmable Active Droop™ |  |
| CorePLUS™ | Global Power Resource™ | QFET® | TinyBoost™ |
| CorePOWER™ | Green FPS™ | QS™ | TinyBuck™ |
| CROSSVOLT™ | Green FPS™ e-Series™ | Quiet Series™ | TinyLogic® |
| CTL™ | GTO™ | RapidConfigure™ | TINYOPTO™ |
| Current Transfer Logic™ | IntelliMAX™ |  | TinyPower™ |
| EcoSPARK® | ISOPLANAR™ | Saving our world, 1mW/W/kW at a time™ | TinyPWM™ |
| EfficientMax™ | MegaBuck™ | SmartMax™ | TinyWire™ |
| EZSWITCH™ | MICROCOUPLER™ | SMART START™ | TriFault Detect™ |
|  | MicroFET™ | SPM® | TRUECURRENT™ |
|  | MicroPak™ | STEALTH™ | µSerDes™ |
| Fairchild® | MillerDrive™ | SuperFET™ |  |
| Fairchild Semiconductor® | MotionMax™ | SuperSOT™3 | UHC® |
| FACT Quiet Series™ | Motion-SPM™ | SuperSOT™6 | Ultra FRFET™ |
| FACT® | OPTOLOGIC® | SuperSOT™8 | UniFET™ |
| FAST® | OPTOPLANAR® | SupreMOS™ | VCC™ |
| FastvCore™ |  | SyncFET™ | VisualMax™ |
| FlashWriter® | PDP SPM™ |  | XST™ |
| FPST™ | Power-SPM™ | The Power Franchise® | |
| F-PFST™ | PowerTrench® | | |
| | PowerXS™ | | |

* Trademarks of System General Corporation, used under license by Fairchild Semiconductor.

DISCLAIMER

FAIRCHILD SEMICONDUCTOR RESERVES THE RIGHT TO MAKE CHANGES WITHOUT FURTHER NOTICE TO ANY PRODUCTS HEREIN TO IMPROVE RELIABILITY, FUNCTION, OR DESIGN. FAIRCHILD DOES NOT ASSUME ANY LIABILITY ARISING OUT OF THE APPLICATION OR USE OF ANY PRODUCT OR CIRCUIT DESCRIBED HEREIN; NEITHER DOES IT CONVEY ANY LICENSE UNDER ITS PATENT RIGHTS, NOR THE RIGHTS OF OTHERS. THESE SPECIFICATIONS DO NOT EXPAND THE TERMS OF FAIRCHILD'S WORLDWIDE TERMS AND CONDITIONS, SPECIFICALLY THE WARRANTY THEREIN, WHICH COVERS THESE PRODUCTS.

LIFE SUPPORT POLICY

FAIRCHILD'S PRODUCTS ARE NOT AUTHORIZED FOR USE AS CRITICAL COMPONENTS IN LIFE SUPPORT DEVICES OR SYSTEMS WITHOUT THE EXPRESS WRITTEN APPROVAL OF FAIRCHILD SEMICONDUCTOR CORPORATION.

As used herein:

1. Life support devices or systems are devices or systems which, (a) are intended for surgical implant into the body or (b) support or sustain life, and (c) whose failure to perform when properly used in accordance with instructions for use provided in the labeling, can be reasonably expected to result in a significant injury of the user.
2. A critical component in any component of a life support, device, or system whose failure to perform can be reasonably expected to cause the failure of the life support device or system, or to affect its safety or effectiveness.

ANTI-COUNTERFEITING POLICY

Fairchild Semiconductor Corporation's Anti-Counterfeiting Policy. Fairchild's Anti-Counterfeiting Policy is also stated on our external website, www.fairchildsemi.com, under Sales Support.

Counterfeiting of semiconductor parts is a growing problem in the industry. All manufacturers of semiconductor products are experiencing counterfeiting of their parts. Customers who inadvertently purchase counterfeit parts experience many problems such as loss of brand reputation, substandard performance, failed applications, and increased cost of production and manufacturing delays. Fairchild is taking strong measures to protect ourselves and our customers from the proliferation of counterfeit parts. Fairchild strongly encourages customers to purchase Fairchild parts either directly from Fairchild or from Authorized Fairchild Distributors who are listed by country on our web page cited above. Products customers buy either from Fairchild directly or from Authorized Fairchild Distributors are genuine parts, have full traceability, meet Fairchild's quality standards for handling and storage and provide access to Fairchild's full range of up-to-date technical and product information. Fairchild and our Authorized Distributors will stand behind all warranties and will appropriately address any warranty issues that may arise. Fairchild will not provide any warranty coverage or other assistance for parts bought from Unauthorized Sources. Fairchild is committed to combat this global problem and encourage our customers to do their part in stopping this practice by buying direct or from authorized distributors.

PRODUCT STATUS DEFINITIONS

Definition of Terms

Datasheet Identification	Product Status	Definition
Advance Information	Formative / In Design	Datasheet contains the design specifications for product development. Specifications may change in any manner without notice.
Preliminary	First Production	Datasheet contains preliminary data; supplementary data will be published at a later date. Fairchild Semiconductor reserves the right to make changes at any time without notice to improve design.
No Identification Needed	Full Production	Datasheet contains final specifications. Fairchild Semiconductor reserves the right to make changes at any time without notice to improve the design.
Obsolete	Not In Production	Datasheet contains specifications on a product that is discontinued by Fairchild Semiconductor. The datasheet is for reference information only.

Rev. I39