

Ceramic Capacitor Compatible, Step-up DC/DC Controllers

GreenOperation Compatible

GENERAL DESCRIPTION

The XC9103/XC9104/XC9105 series are PWM, PWM/PFM auto switching /manual switching controlled universal step-up DC/DC converter controllers.

Output will be stable no matter which load capacitors are used but should a low ESR capacitor be used, R_{SENSE} of about 0.1 will be required and phase compensation will be achieved. This allows the use of ceramic capacitors and enables to obtain lower output ripple and small PCB design. Tantalum and electrolytic capacitors can also be used, in which case, R_{SENSE} becomes unnecessary.

With 0.9V internal voltage reference and by using externally connected two resistors, output voltage can be set freely within a range of 1.5V to 30V. The series is available in 300 kHz and 180 kHz frequencies, the size of the external components can be reduced. 100 kHz and 500 kHz are also available in custom options.

The XC9103 offers PWM operation. The XC9104 offers PWM/PFM automatic switching operation. The PWM operation is shifted to the PFM operation automatically at light load so that it maintains high efficiency over a wide range of load currents. The XC9105 offers both PWM and PWM/PFM auto switching operations and it can be selected by external signal.

A current limiter circuit is built-in to the IC (except with the 500 kHz version) and monitors the ripple voltage on the FB pin. Operation is shut down when the ripple voltage is more than 250mV. The operations of the IC can be returned to normal with a toggle of the CE pin or by turning the power supply back on.

APPLICATIONS

PDA's
Cellular phones
Palmtop computers
Portable audio systems
Various multi-function power supplies

FEATURES

Input Voltage Range	: 0.9V ~ 10V
Supply Voltage Range	: 1.8V ~ 10V
Output Voltage Range	: 1.5V ~ 30V Set freely with the reference voltage 0.9V ($\pm 2.0\%$) and two resistors
Oscillation Frequency	: 100, 180, 300, 500kHz ($\pm 15\%$) 180, 300kHz only for XC9103/04/05B type (with current limiter)
Output Current	: more than 400mA ($V_{IN}=1.8V, V_{OUT}=3.3V$)
Controls	: PWM (XC9103) PWM/PFM auto-switching (XC9104) PWM/PFM manual switching (XC9105)
High Efficiency	: 85% (TYP.)
Stand-by Current	: $I_{STB}=1.0 \mu A$ (MAX.)
Load Capacitors	: Low ESR capacitors compatible
Current	: Operates when ripple voltage=250mV
Limiter Function	: Also available without current limiter (100kHz and 500kHz types are available only without current limiter)
Package	: SOT-25, USP-6B

TYPICAL APPLICATION CIRCUIT

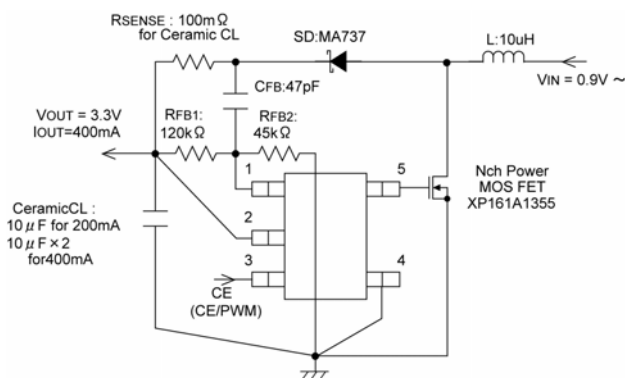

TYPICAL PERFORMANCE CHARACTERISTICS

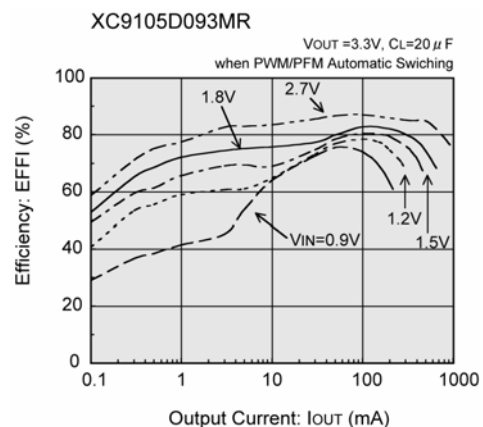

PIN CONFIGURATION

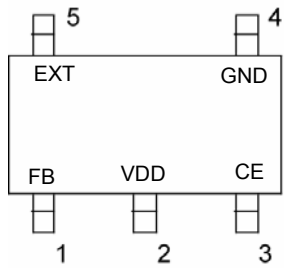

SOT-25
(TOP VIEW)

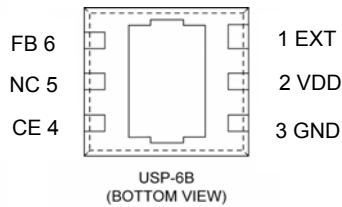

The dissipation pad for the USP-6B package should be solder-plated in recommended mount pattern and metal masking so as to enhance mounting strength and heat release.
If the pad needs to be connected to other pins, it should be connected to the VDD (No.2) pin.

PIN ASSIGNMENT

PIN NUMBER		PIN NAME	FUNCTION
SOT-25	USP-6B		
1	6	FB	Output Resistor Connection
2	2	VDD	Supply Voltage
3	4	CE	Chip Enable
		CE (/PWM)	Serves as both PWM/PFM switching pin and CE pin for XC9105
4	3	GND	Ground
5	1	EXT	External Transistor Connection
-	5	NC	No Connection

PRODUCT CLASSIFICATION

Ordering Information

XC9103 _____ : PWM Control
 XC9104 _____ : PWM/PFM Automatic Switching Control
 XC9105 _____ : PWM/PFM Manual Switching Control

DESIGNATOR	DESCRIPTION	SYMBOL	DESCRIPTION
①	Type of DC/DC Controller	B	: With current limiter (180kHz, 300kHz only)
		D	: Without current limiter
② ③	Output Voltage	09	: FB voltage (e.g. FB Voltage=0.9V→②=0, ③=9)
④	Oscillation Frequency	3	: 300kHz
		1	: 100kHz
		2	: 180kHz
		5	: 500kHz
⑤	Package	M	: SOT-25 (SOT-23-5)
		D	: USP-6B
⑥	Device Orientation	R	: Embossed tape, standard feed
		L	: Embossed tape, reverse feed

BLOCK DIAGRAM

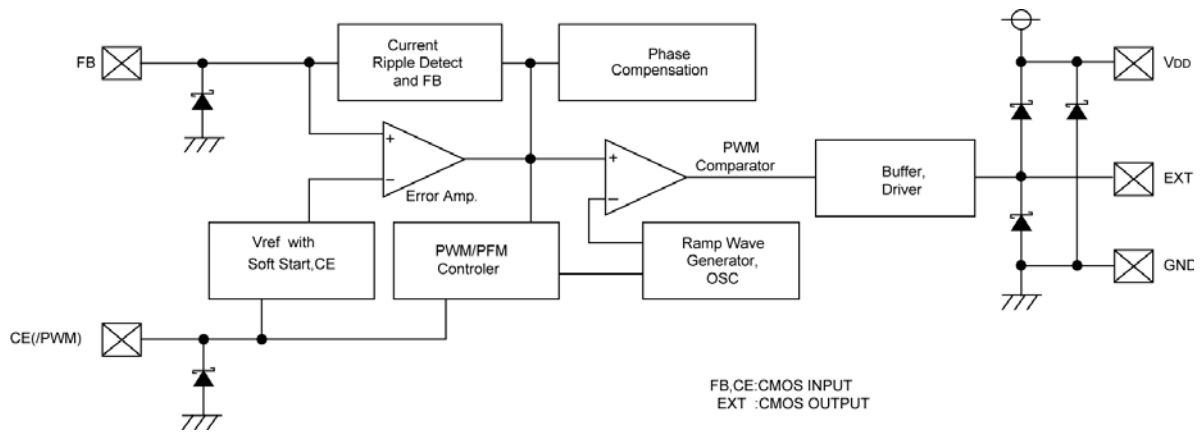

ABSOLUTE MAXIMUM RATINGS

Ta=25

PARAMETER	SYMBOL	RATINGS	UNITS
VDD pin Voltage	VDD	-0.3 ~ 12.0	V
FB pin Voltage	FB	-0.3 ~ 12.0	V
CE pin Voltage	VCE	-0.3 ~ 12.0	V
EXT pin Voltage	VEXT	-0.3 ~ VDD + 0.3	V
EXT pin Current	IEXT/	±100	mA
Power Dissipation	SOT-25	150	mW
	USP-6B	100	
Operating Temperature Range	Topr	-40 ~ +85	
Storage Temperature Range	Tstg	-40 ~ +125	

ELECTRICAL CHARACTERISTICS

XC9103B092MR, XC9104B092MR, XC9105B092MR
 XC9103D092MR, XC9104D092MR, XC9105D092MR

(FOSC=180kHz)

Ta=25

PARAMETER	SYMBOL	CONDITIONS	MIN.	TYP.	MAX.	UNITS	CIRCUIT
Output Voltage	V _{OUT}		3.234	3.300	3.366	V	
Output Voltage Range	V _{OUTSET}	V _{IN} =V _{OUTSET} ×0.6, V _{DD} =3.3V I _{OUT} =10mA, Using 2SD1628	1.5	-	30.0	V	
FB Control Voltage	V _{FB}		0.882	0.900	0.918	V	
Supply Voltage Range (*1)	V _{DD}		1.8	-	10.0	V	
Operation Start Voltage	V _{ST1}	Recommended circuit using 2SD1628, I _{OUT} =1.0mA	-	-	0.9	V	
Oscillation Start Voltage (*1)	V _{ST2}	No external components, CE connected to V _{DD} , Voltage applied, FB=0V	-	-	0.8	V	
Operation Hold Voltage	V _{HLD}	Recommended circuit using 2SD1628, I _{OUT} =1.0mA	-	-	0.7	V	
Supply Current 1	I _{DD1}	Same as V _{ST2} , V _{DD} =3.3V	-	45	64	μA	
Supply Current 2	I _{DD2}	Same as I _{DD1} , FB=1.2V	-	17	24	μA	
Stand-by Current	I _{STB}	Same as I _{DD1} , CE=0V	-	-	1.0	μA	
Oscillation Frequency	FOSC	Same as I _{DD1}	153	180	207	kHz	
Maximum Duty Cycle	MAXDTY	Same as I _{DD1}	75	81	87	%	
PFM Duty Rate	PFMDTY	No load (XC9104B/D, 9105B/D)	20	28	36	%	
Overcurrent Sense Voltage (*3)	V _{LMT}	Step input to FB (Pulse width: 2.0 μS or more), EXT=Low level voltage (XC9103B, 9104B, 9105B)	170	250	330	mV	
Efficiency	EFFI	Recommended circuit using XP161A1355	-	85	-	%	
Soft-Start Time	T _{SS}		5.0	10.0	20.0	ms	
CE "High" Voltage (*2)	V _{CEH}	Same as I _{DD1}	0.65	-	-	V	
CE "Low" Voltage (*2)	V _{CEL}	Same as I _{DD1}	-	-	0.20	V	
PWM "High" Voltage (*2)	V _{PWMH}	I _{OUT} =1.0mA (XC9105B/D)	V _{DD} -0.2	-	-	V	
PWM "Low" Voltage (*2)	V _{PWML}	I _{OUT} =1.0mA (XC9105B/D)	-	-	V _{DD} -1.0	V	
EXT "High" On Resistance	R _{EXTH}	Same as I _{DD1} , V _{EXT} =V _{OUT} -0.4V	-	24	36		
EXT "Low" On Resistance	R _{EXTL}	Same as I _{DD1} , V _{EXT} =0.4V	-	16	24		
CE "High" Current	I _{CEH}	Same as I _{DD2} , CE=V _{DD}	-	-	0.1	μA	
CE "Low" Current	I _{CEL}	Same as I _{DD2} , CE=0V	-	-	-0.1	μA	
FB "High" Current	I _{FBH}	Same as I _{DD2} , CE=V _{DD}	-	-	0.1	μA	
FB "Low" Current	I _{FBL}	Same as I _{DD2} , CE=0V	-	-	-0.1	μA	

Test Conditions: Unless otherwise stated, CL: ceramic, recommended MOSFET should be connected.
 V_{OUT}=3.3V, V_{IN}=2.0V, I_{OUT}=170mA

NOTE:

- *1 Although the IC starts step-up operations from a V_{DD} of 0.8V, the output voltage and oscillation frequency are stabilized at V_{DD}≥1.8V. Therefore, a V_{DD} of more than 1.8V is recommended when V_{DD} is supplied from V_{IN} or other power sources.
- *2 With the XC9105 series, the CE pin also serves as a PWM/PFM switching pin. In operation, PWM control is selected when the voltage at the CE pin is more than V_{DD}-0.2V. On the other hand, PWM/PFM automatic switching control at a duty = 25% is selected when the voltage at the CE pin is less than V_{DD}-1.0V and more than V_{CEL}.
- *3 The overcurrent limit circuit of this IC is designed to monitor the ripple voltage so please select your external components carefully to prevent V_{LMT} being reached under low temperature conditions as well as normal operating conditions. Following current limiter circuit operations, which in turn causes the IC's operations to stop, the operations of the IC can be returned to normal with a toggle of the CE pin or by turning the power supply back on.

ELECTRICAL CHARACTERISTICS (Continued)

XC9103B093MR, XC9104B093MR, XC9105B093MR
XC9103D093MR, XC9104D093MR, XC9105D093MR

(FOSC=300 kHz)

Ta=25

PARAMETER	SYMBOL	CONDITIONS	MIN.	TYP.	MAX.	UNITS	CIRCUIT
Output Voltage	V _{OUT}		3.234	3.300	3.366	V	
Output Voltage Range	V _{OUTSET}	V _{IN} =V _{OUTSET} ×0.6, V _{DD} =3.3V I _{OUT} =10mA, Using 2SD1628	1.5	-	30.0	V	
FB Control Voltage	V _{FB}		0.882	0.900	0.918	V	
Supply Voltage Range (*1)	V _{DD}		1.8	-	10.0	V	
Operation Start Voltage	V _{ST1}	Recommended circuit using 2SD1628, I _{OUT} =1.0mA	-	-	0.9	V	
Oscillation Start Voltage (*1)	V _{ST2}	No external components, CE connected to V _{DD} , Voltage applied, FB=0V	-	-	0.8	V	
Operation Hold Voltage	V _{HLD}	Recommended circuit using 2SD1628, I _{OUT} =1.0mA	-	-	0.7	V	
Supply Current 1	I _{DD1}	Same as V _{ST2} , V _{DD} =3.3V	-	62	88	μA	
Supply Current 2	I _{DD2}	Same as I _{DD1} , FB=1.2V	-	16	22	μA	
Stand-by Current	I _{STB}	Same as I _{DD1} , CE=0V	-	-	1.0	μA	
Oscillation Frequency	FOSC	Same as I _{DD1}	255	300	345	kHz	
Maximum Duty Cycle	MAXDTY	Same as I _{DD1}	75	81	87	%	
PFM Duty Rate	PFMDTY	No load (XC9104B/D, 9105B/D)	24	32	40	%	
Overcurrent Sense Voltage (*3)	V _{LMT}	Step input to FB (Pulse width: 2.0 μs or more), EXT=Low level voltage (XC9103B, 9104B, 9105B)	220	300	380	mV	
Efficiency	EFFI	Recommended circuit using XP161A1355	-	85	-	%	
Soft-Start Time	T _{SS}		5.0	10.0	20.0	ms	
CE "High" Voltage (*2)	V _{CEH}	Same as I _{DD1}	0.65	-	-	V	
CE "Low" Voltage (*2)	V _{CEL}	Same as I _{DD1}	-	-	0.20	V	
PWM "High" Voltage (*2)	V _{PWMH}	I _{OUT} =1.0mA (XC9105B/D)	V _{DD} -0.2	-	-	V	
PWM "Low" Voltage (*2)	V _{PWML}	I _{OUT} =1.0mA (XC9105B/D)	-	-	V _{DD} -1.0	V	
EXT "High" On Resistance	R _{EXTH}	Same as I _{DD1} , V _{EXT} =V _{OUT} -0.4V	-	24	36		
EXT "Low" On Resistance	R _{EXTL}	Same as I _{DD1} , V _{EXT} =0.4V	-	16	24		
CE "High" Current	I _{CEH}	Same as I _{DD2} , CE=V _{DD}	-	-	0.1	μA	
CE "Low" Current	I _{CEL}	Same as I _{DD2} , CE=0V	-	-	-0.1	μA	
FB "High" Current	I _{FBH}	Same as I _{DD2} , CE=V _{DD}	-	-	0.1	μA	
FB "Low" Current	I _{FBL}	Same as I _{DD2} , CE=0V	-	-	-0.1	μA	

Test Conditions: Unless otherwise stated, CL: ceramic, recommended MOSFET should be connected.

NOTE:

- *1 Although the IC starts step-up operations from a V_{DD} of 0.8V, the output voltage and oscillation frequency are stabilized at V_{DD}≥1.8V. Therefore, a V_{DD} of more than 1.8V is recommended when V_{DD} is supplied from V_{IN} or other power sources.
- *2 With the XC9105 series, the CE pin also serves as a PWM/PFM switching pin. In operation, PWM control is selected when the voltage at the CE pin is more than V_{DD} -0.2V. On the other hand, PWM/PFM automatic switching control at a duty = 25% is selected when the voltage at the CE pin is less than V_{DD} -1.0V and more than V_{CEH}.
- *3 The overcurrent limit circuit of this IC is designed to monitor the ripple voltage so please select your external components carefully to prevent V_{LMT} being reached under low temperature conditions as well as normal operating conditions. Following current limiter circuit operations, which in turn causes the IC's operations to stop, the operations of the IC can be returned to normal with a toggle of the CE pin or by turning the power supply back on.

TYPICAL APPLICATION CIRCUIT

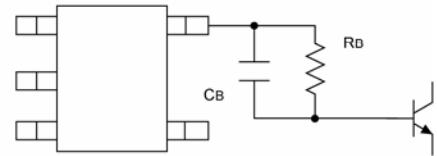
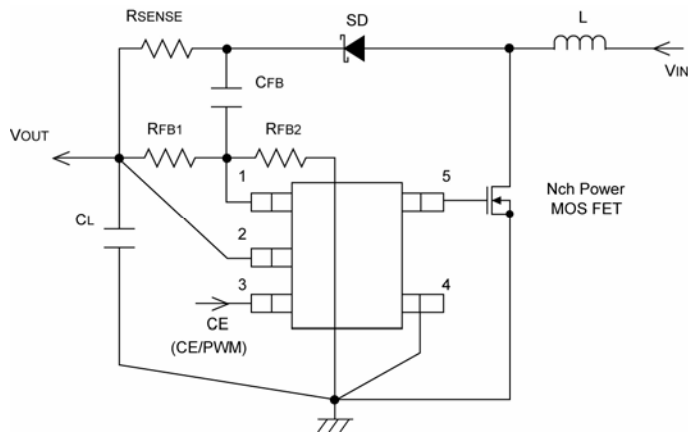

When obtaining V_{DD} from a source other than V_{OUT} , please insert a capacitor C_{IN} between the V_{DD} pin and the GND pin in order to provide stable operations.

Please place C_L and C_{IN} as close as to the V_{OUT} and V_{DD} pins respectively and also close to the GND pin. Strengthen the wiring sufficiently. R_{SENSE} should be removed and shorted when the C_L capacitor except for ceramic or low ESR capacitor is used.

Insert R_B and C_B when using a bipolar NPN Transistor.

NOTES ON USE

<XC9105 CE/PWM PIN>

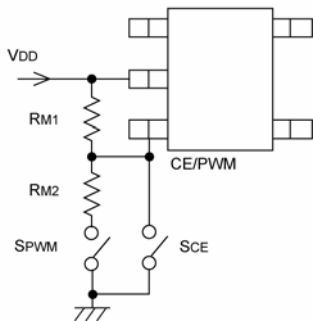

SCE	SPWM	CONDITIONS
ON	-	Chip Disable
OFF	ON	Duty=25%, PWM/PFM automatic switching
OFF	OFF	PWM

By using external signals, the control of the XC9105 series can be alternated between PWM control and PWM/PFM automatic switching control. By inputting a voltage of more than $V_{DD} - 0.2V$ to the CE/PWM pin, PWM control can be selected. On the other hand, PWM/PFM automatic switching control can be selected by inputting a voltage of less than $V_{DD} - 1.0V$.

With the XC9105, by connecting resistors of the same value (R_{M1} , R_{M2}) as shown in the diagram to the left, it is possible to obtain chip disable with SCE ON and, SPWM ON or OFF, PWM/PFM auto switching at Duty=25% with SCE OFF & SPWM ON, & PFM control with both switches OFF.

Note:

When operating at $V_{DD} - 1.8V$ and below (stepping-up from $V_{IN}=0.9V$), it is necessary to pull-up to V_{DD} in order to allow the CE/PWM pin reach the V_{CEH} voltage level. Please make sure that the IC is in PWM control (SPWM=OFF) when operations start. If SPWM is ON, there are times when chip enable might not operate.

* Please select your external components carefully.

OPERATIONAL EXPLANATION

The XC9103/04/05 series are step-up DC/DC converter controller ICs with built-in high speed, low ON resistance drivers.

<Error Amp.>

Error amplifier is designed to monitor the output voltage, comparing the feedback voltage (FB) with the reference voltage Vref. In response to feedback of a voltage lower than the reference voltage Vref, the output voltage of the error amp. decreases.

<OSC Generator>

This circuit generates the internal reference clock.

<Ramp Wave Generator>

The ramp wave generator generates a saw-tooth waveform based on outputs from the OSC Generator.

<PWM Comparator>

The PWM comparator compares outputs from the error amp. and saw-tooth waveform. When the voltage from the Error Amp's output is low, the external switch will be set to ON.

<PWM/PFM Controller>

This circuit generates PFM pulses.

The PWM/PFM automatic switching mode switches between PWM and PFM automatically depending on the load. The PWM/PFM automatic switching mode is selected when the voltage of the CE pin is less than $V_{DD} - 1.0V$, and the control switches between PWM and PFM automatically depending on the load. PWM/PFM control turns into PFM control when threshold voltage becomes lower than voltage of error amps. PWM control mode is selected when the voltage of the CE pin is more than $V_{DD} - 0.2V$. Noise is easily reduced with PWM control since the switching frequency is fixed. The series is suitable for noise sensitive portable audio equipment as PWM control can suppress noise during operation and PWM/PFM switching control can reduce consumption current during light load in stand-by.

<Vref 1 with Soft Start>

The reference voltage, Vref (FB pin voltage)=0.9V, is adjusted and fixed by laser trimming (for output voltage settings, please refer to the notes on next page). To protect against inrush current, when the power is switched on, and also to protect against voltage overshoot, soft-start time is set internally to 10ms. It should be noted, however, that this circuit does not protect the load capacitor (CL) from inrush current. With the Vref voltage limited and depending upon the input to the error amps, the operation maintains a balance between the two inputs of the error amps and controls the EXT pin's ON time so that it doesn't increase more than is necessary.

<Enable Function>

This function controls the operation and shutdown of the IC. When the voltage of the CE pin is 0.2V or less, the mode will be disable, the channel's operations will stop and the EXT1 pin will be kept at a low level (the external N-type MOSFET will be OFF). When the IC is in a state of disable, current consumption will be no more than $1.0 \mu A$.

When the CE pin's voltage is 0.65V or more, the mode will be enabled and operations will recommence.

OPERATIONAL EXPLANATION (Continued)

< Output Voltage Setting >

Output voltage can be set by adding external split resistors. Output voltage is determined by the following equation, based on the values of RFB1 and RFB2. The sum of RFB1 and RFB2 should normally be 2 M or less.

$$V_{OUT} = 0.9 \times (R_{FB1} + R_{FB2}) / R_{FB2}$$

The value of CFB1, speed-up capacitor for phase compensation, should result in $f_{zfb} = 1/(2 \times C_{FB} \times R_{FB1})$ equal to 5 to 30kHz. Adjustments are required depending on the application, value of inductance (L), and value of load capacity (CL).

fzfb = 30kHz (L=10 μH)	[Example of Equation]
fzfb = 20kHz (L=22 μH)	RFB1 : 120k RFB2 : 45k
fzfb = 10kHz (L=47 μH)	CFB : 47pF (fzfb = 30kHz, L = 10 μH)
	68pF (fzfb = 20kHz, L = 22 μH)
	130pF (fzfb = 10kHz, L = 47 μH)

< The use of ceramic capacitor CL >

The circuit of the XC9103/04/05 series is organized by a specialized circuit, which reenacts negative feedback of both voltage and current. Also by insertion of approximately 100m of a low and inexpensive sense resistor as current sense, a high degree of stability is possible even using a ceramic capacitor, a condition which used to be difficult to achieve. Compared to a tantalum condenser, because the series can be operated in a very small capacity, it is suited to use of the ceramic capacitor, which is cheap and small.

< External Components >

Tr	:*When a MOSFET is used: XP161A1355PR (N-ch Power MOSFET, TOREX) Note*: As the breakdown voltage of XP161A1355 is 8V, take care with the power supply voltage. With output voltages over 6V, use the XP161A1265 with a breakdown voltage of 12V. VST1: XP161A1355PR = 1.2V (MAX.) XP161A1265PR = 1.5V (MAX.)	*When a NPN Tr. Is used: 2SD1628 (SANYO) R _B : 500 (Adjust with Tr's HSE or load) C _B : 2200pF (Ceramic type set so that R _B and pole is less than 70% of FOSC) C _B ≤ 1 / (2 × R _B × FOSC × 0.7)
SD	:MA2Q737 (Schottky type, MATSUSHITA)	
L, CL	:When Using Ceramic Type	
L	:22 μH (CDRH5D28, SUMIDA, FOSC = 100, 180kHz) 10 μH (CDRH5D18, SUMIDA, FOSC = 300, 500kHz)	
CL	:10V 10 μF (Ceramic Type, LMK325BJ106ML, TAIYO YUDEN) Use the formula below when step-up ratio and output current is large. $CL = (CL \text{ standard value}) \times (I_{OUT}(mA) / 300mA \times V_{OUT} / V_{IN})$	
R _{SENSE}	:100m (FOSC = 180, 300, 500kHz) 50m (FOSC = 100kHz)	
CL	:Tantalum Type	
L	:22 μH (CDRH5D28, SUMIDA, FOSC = 300kHz) 47 μH (CDRH5D28, SUMIDA, FOSC = 100, 180kHz) Except when $I_{OUT}(mA) / 100mA \times V_{OUT} / V_{IN} > 2$ 22 μH 10 μH (CDRH5D18, SUMIDA, FOSC = 500kHz)	
CL	:16V, 47 μF (Tantalum Type 16MCE476MD2, NICHICHEMI) Use the formula below when step-up ratio and output current is large. $CL = (CL \text{ standard value}) \times (I_{OUT}(mA) / 300mA \times V_{OUT} / V_{IN})$	
R _{SENSE}	:Not required, but short out the wire.	
CL	:AL Electrolytic Type	
L	:22 μH (CDRH5D28 SUMIDA, FOSC = 300kHz) 47 μH (CDRH5D28 SUMIDA, FOSC = 100, 180kHz) Except when $I_{OUT}(mA) / 100mA \times V_{OUT} / V_{IN} > 2$ 22 μH	
CL	:16V, 100 μF (AL Electrolytic Type) + 10V, 2.2 μF (Ceramic Type) Strengthen appropriately when step-up ratio and output current is large.	
R _{SENSE}	:Not required, but short out the wire.	
CFB	:Set up so that fzfb = 100kHz.	

TEST CIRCUITS

Circuit

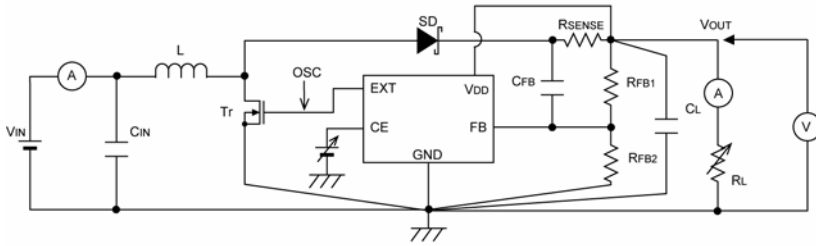

Circuit

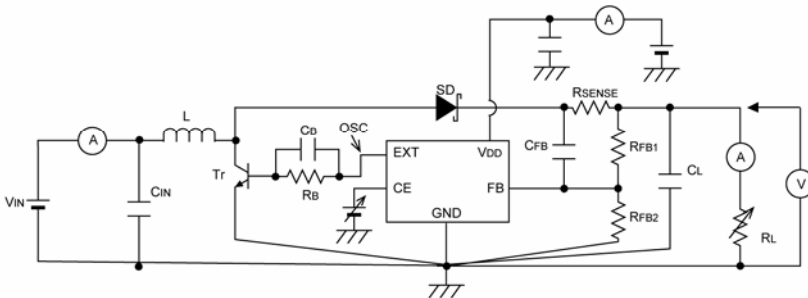

Circuit

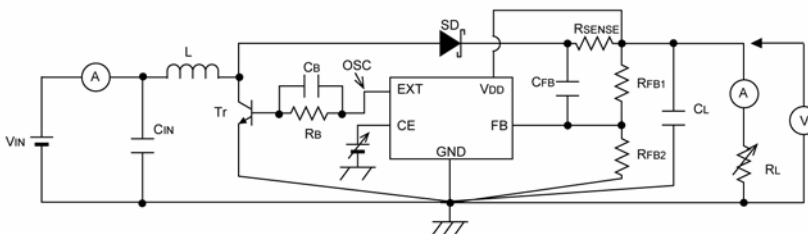

Circuit

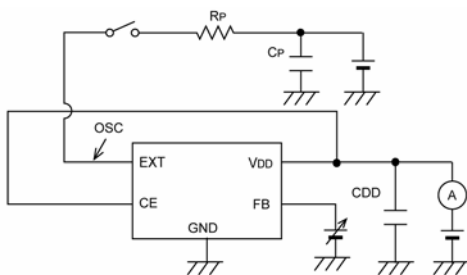

Circuit

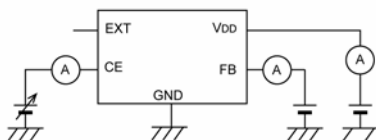

Circuit

Pulse voltage is applied at the FB pin using the test circuit

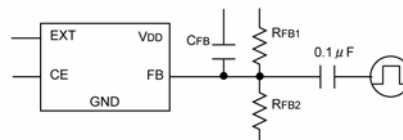

TYPICAL PERFORMANCE CHARACTERISTICS

(1) Output Voltage vs. Output Current

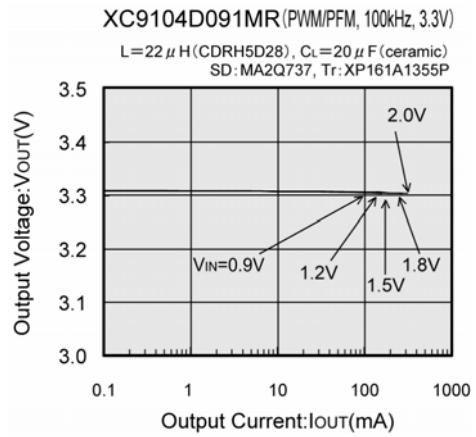
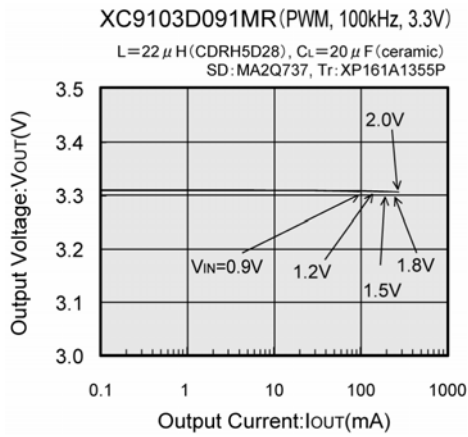
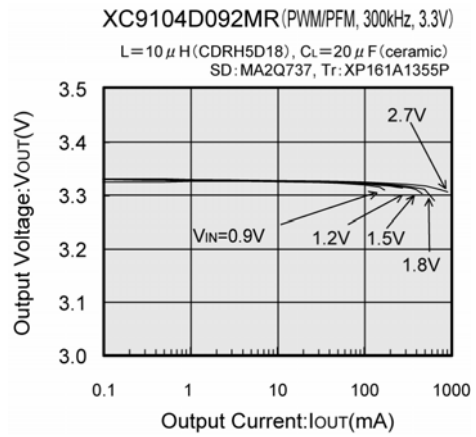
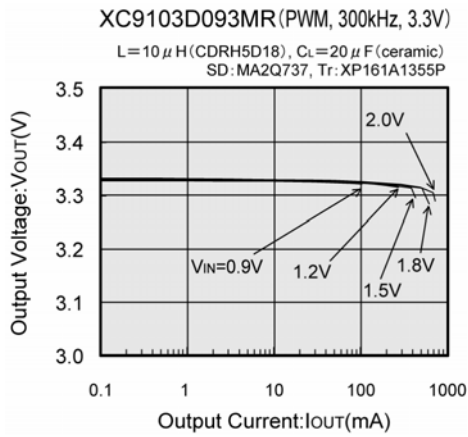
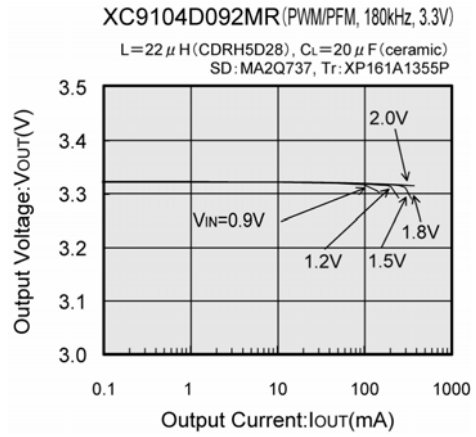
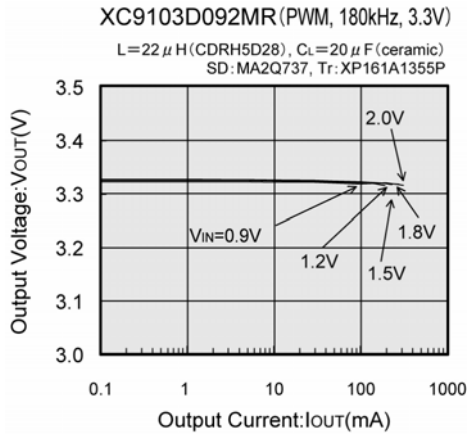

TYPICAL PERFORMANCE CHARACTERISTICS (Continued)

(1) Output Voltage vs. Output Current (Continued)

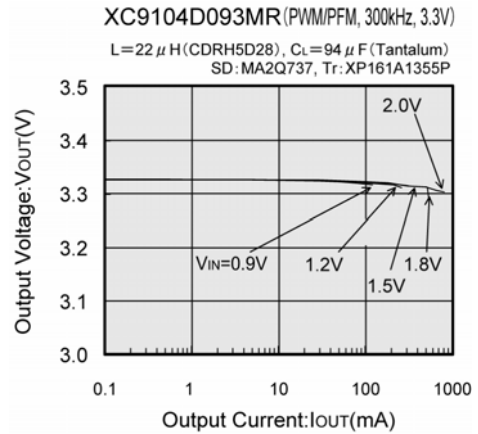
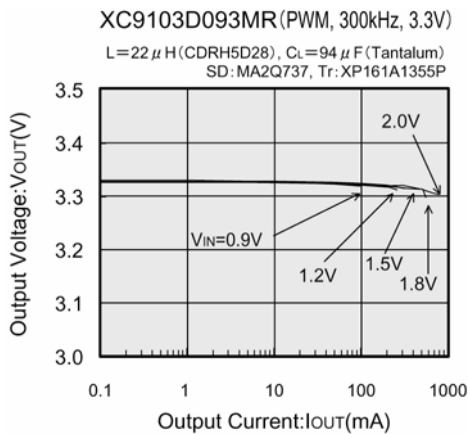
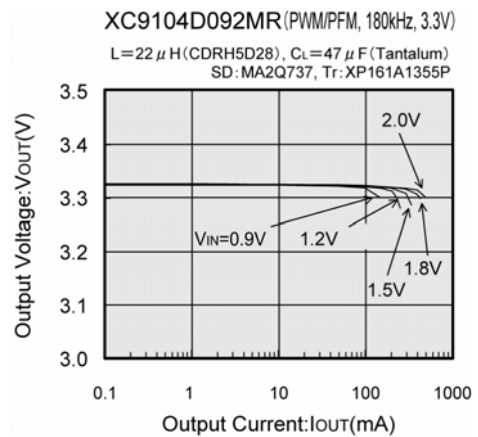
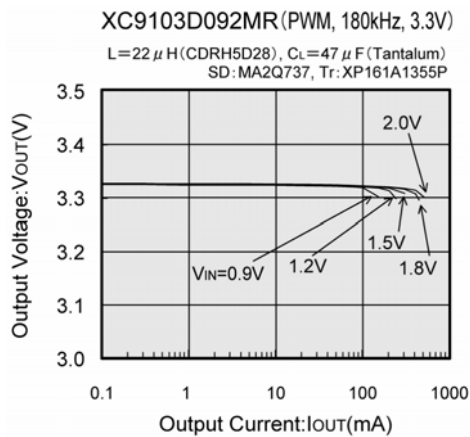
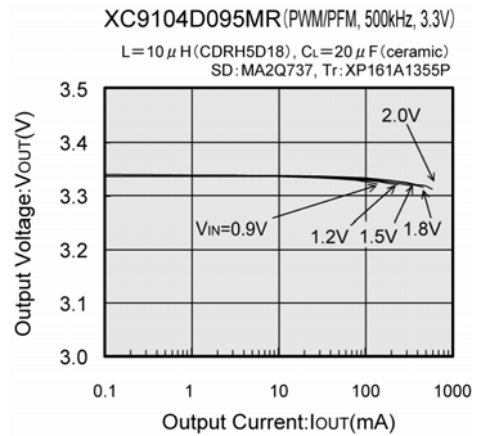
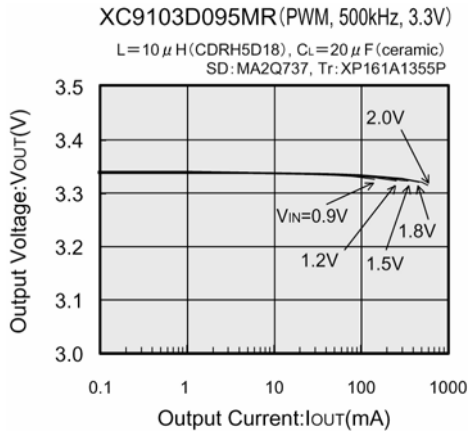

TYPICAL PERFORMANCE CHARACTERISTICS (Continued)

(2) Efficiency vs. Output Current (Continued)

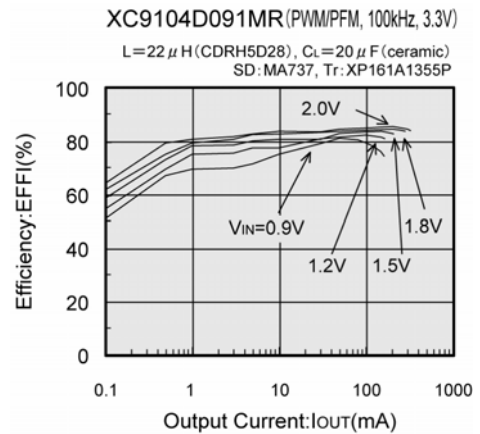
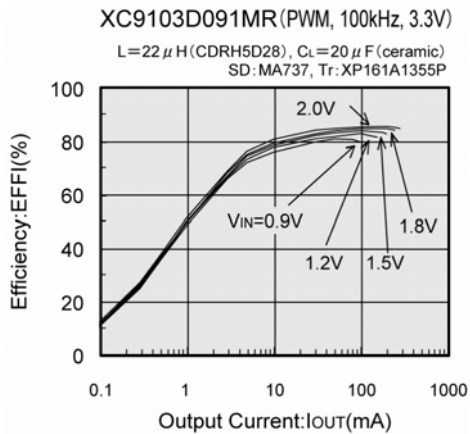
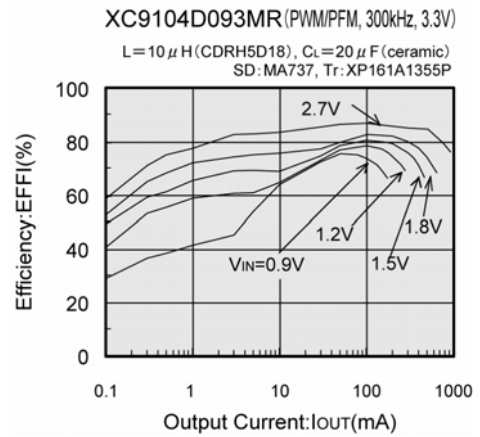
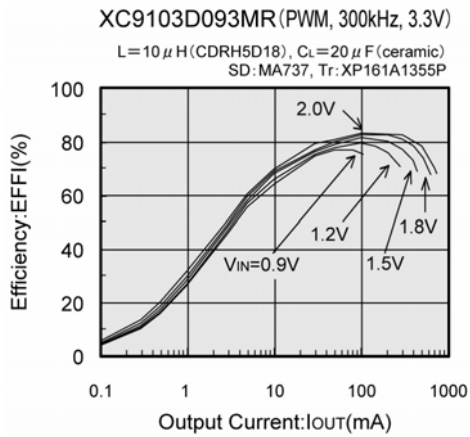
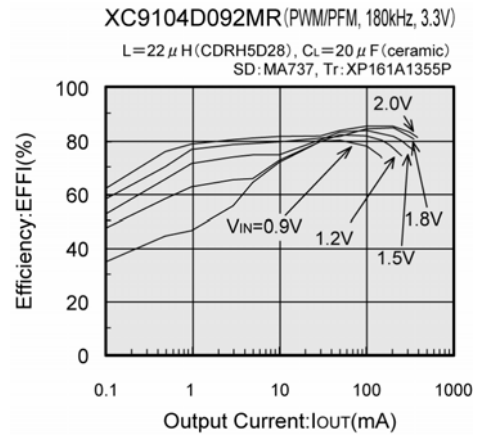
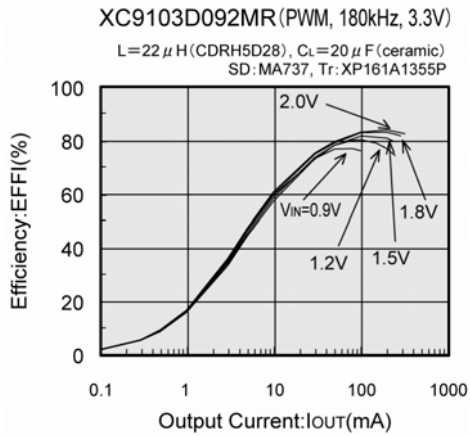

TYPICAL PERFORMANCE CHARACTERISTICS (Continued)

(2) Efficiency vs. Output Current (Continued)

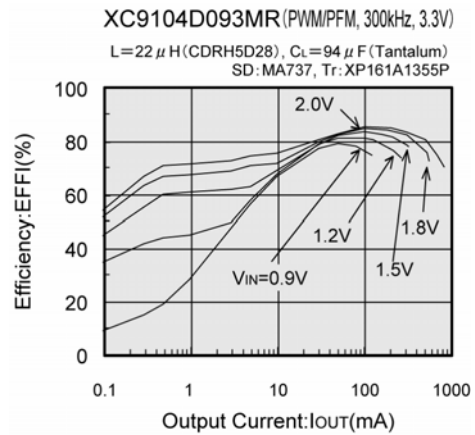
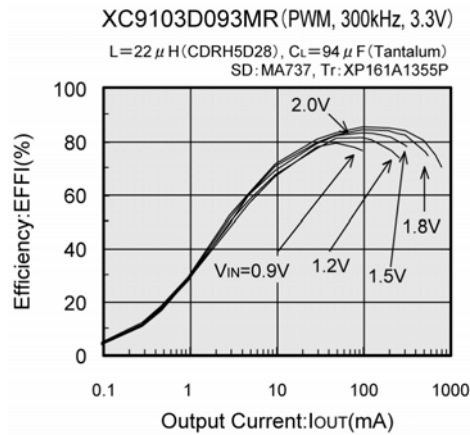
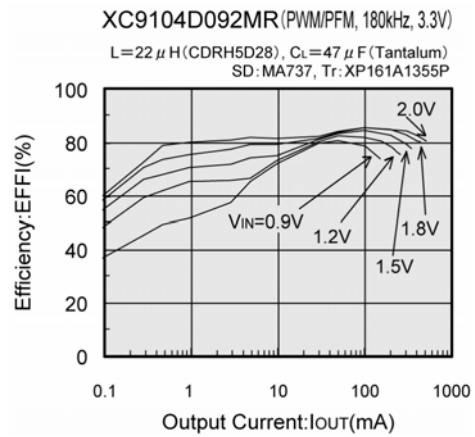
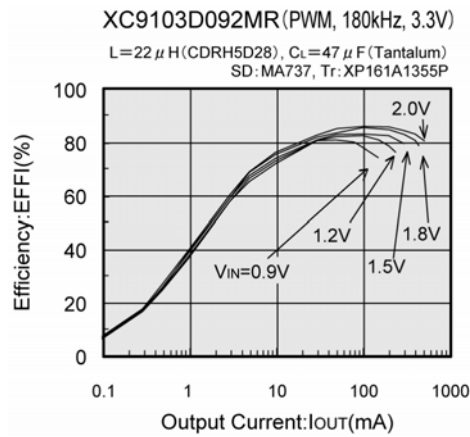
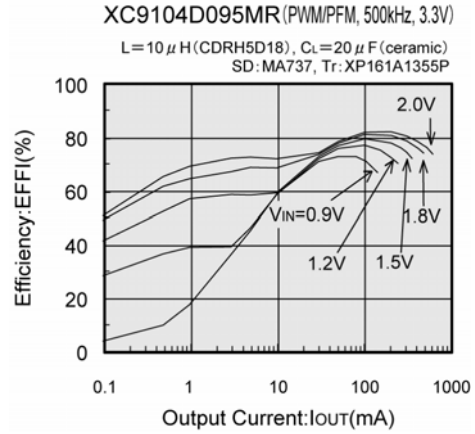
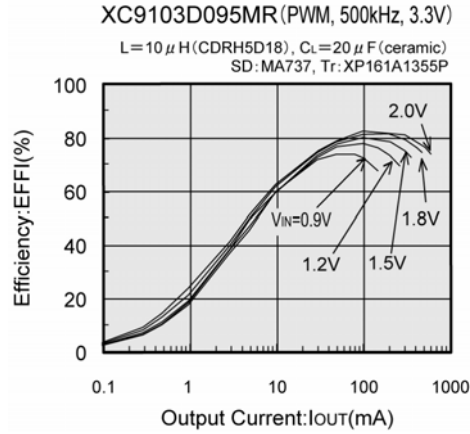

TYPICAL PERFORMANCE CHARACTERISTICS (Continued)

(3) Load Transient Response

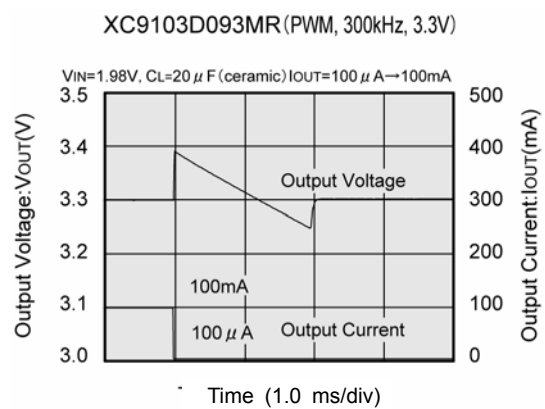
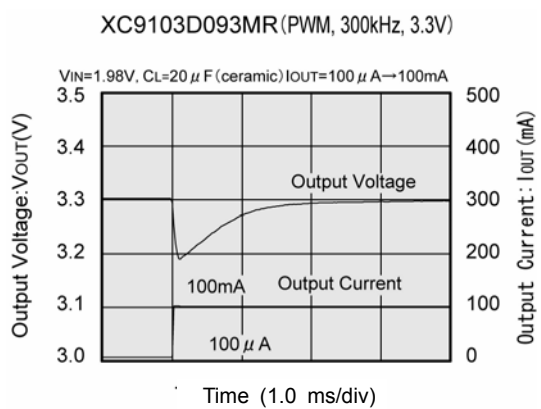
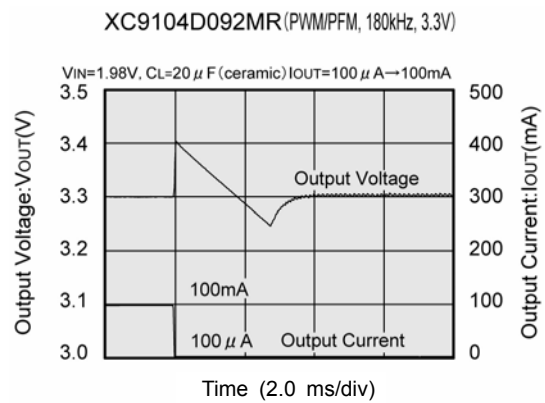
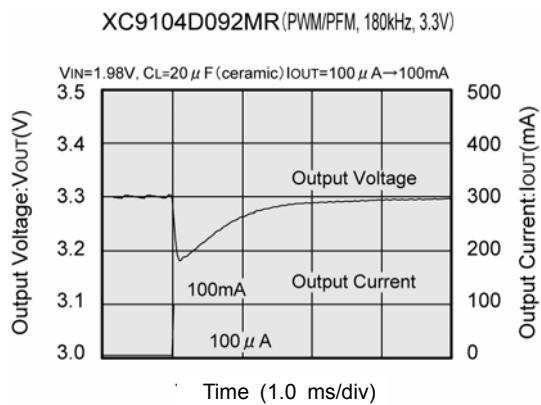
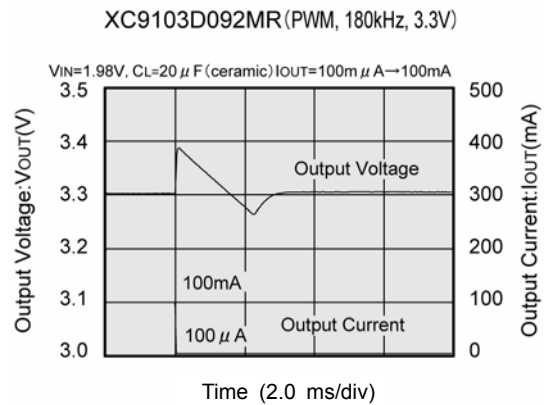
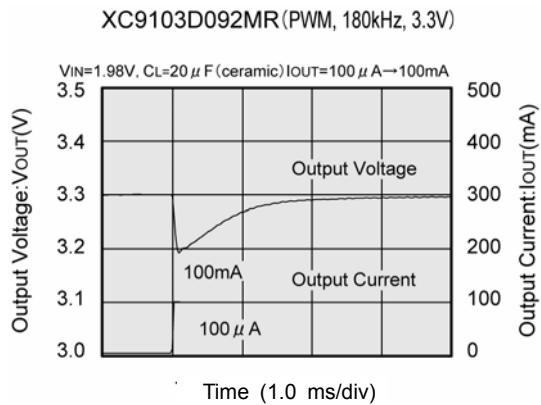

TYPICAL PERFORMANCE CHARACTERISTICS (Continued)

(3) Load Transient Response (Continued)

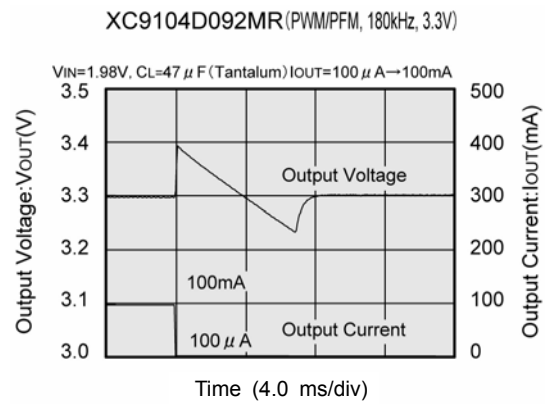
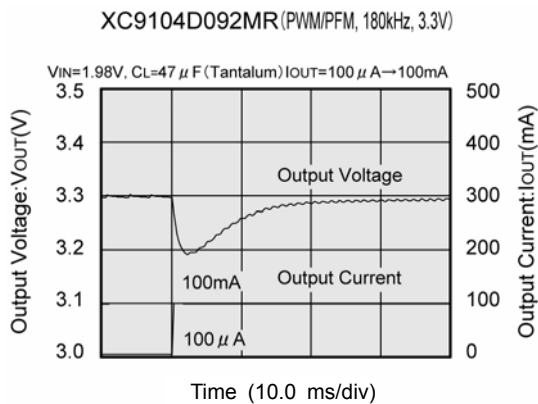
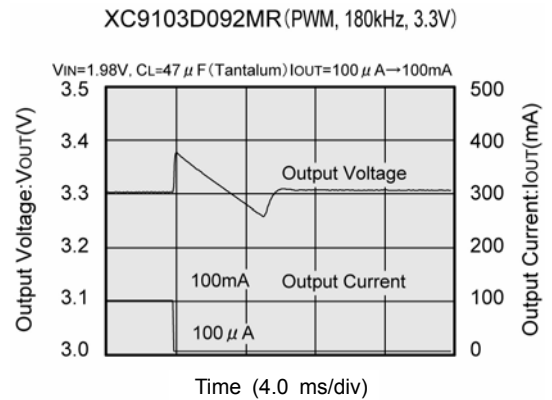
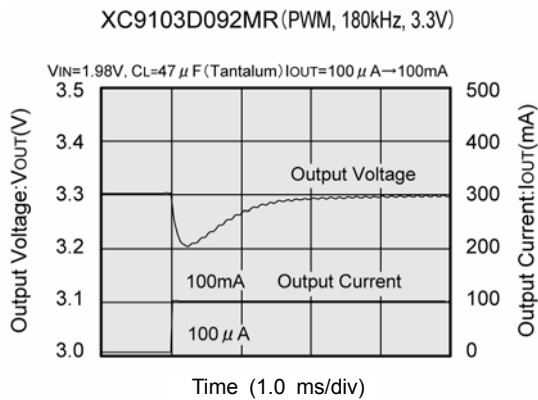
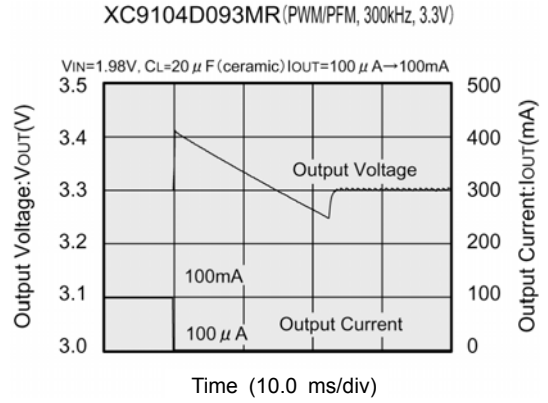
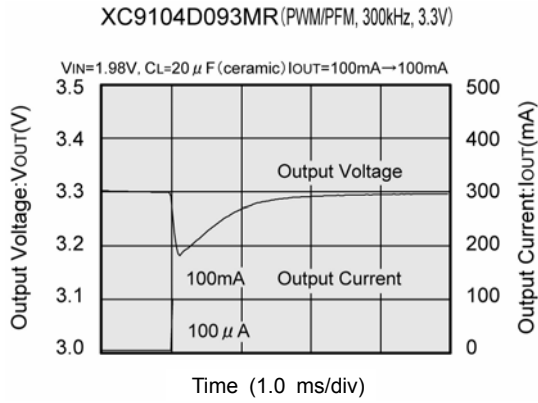

TYPICAL PERFORMANCE CHARACTERISTICS (Continued)

(4) Output Voltage vs. Power Supply Voltage

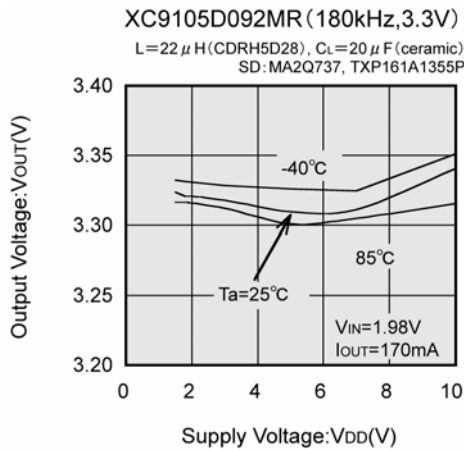

(5) Supply Current 1 vs. Power Supply Voltage

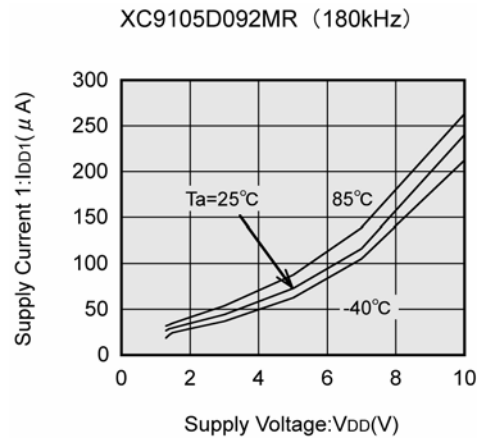

(6) Supply Current 2 vs. Power Supply Voltage

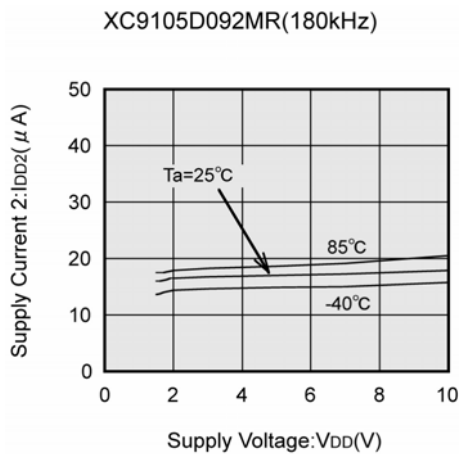

(7) Stand-By Current vs. Power Supply Voltage

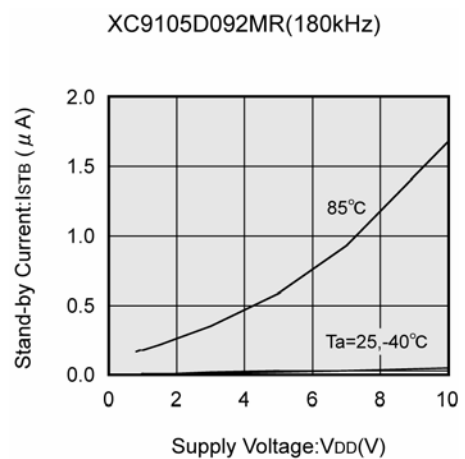

(8) Oscillation Frequency vs. Power Supply Voltage

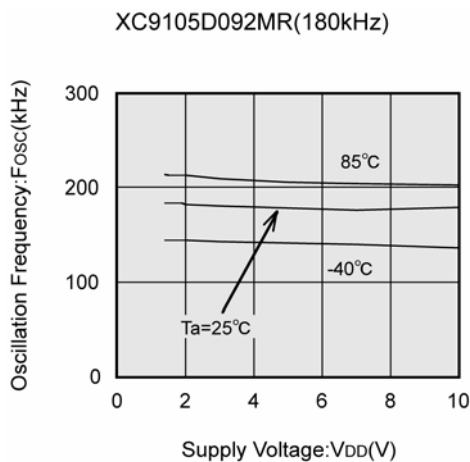

(9) Maximum Duty Ratio vs. Power Supply Voltage

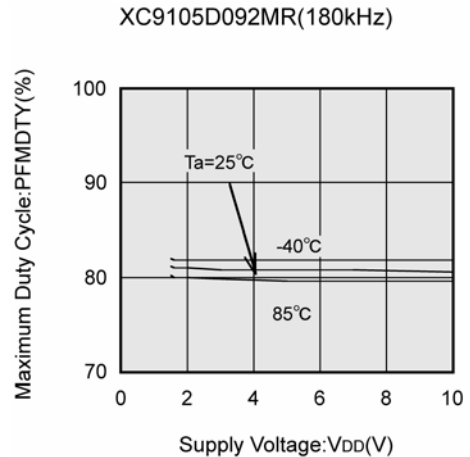

TYPICAL PERFORMANCE CHARACTERISTICS (Continued)

(10) PFM Duty Ratio vs. Power Supply Voltage

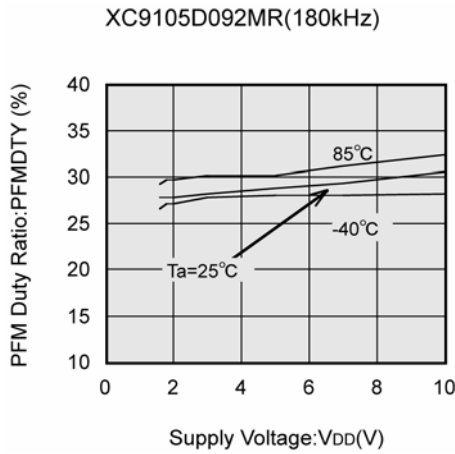

(11) Overcurrent Sense Voltage vs. Power Supply Voltage

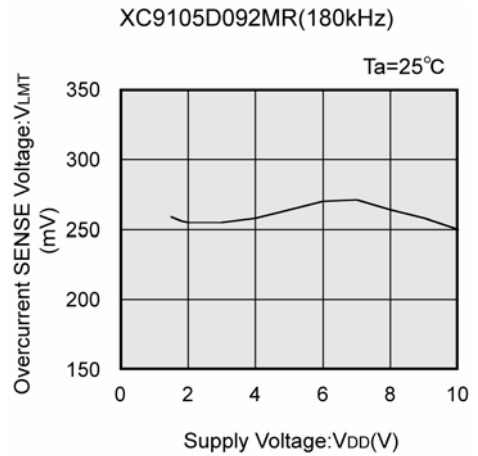

(12) Soft Start Time vs. Power Supply Voltage

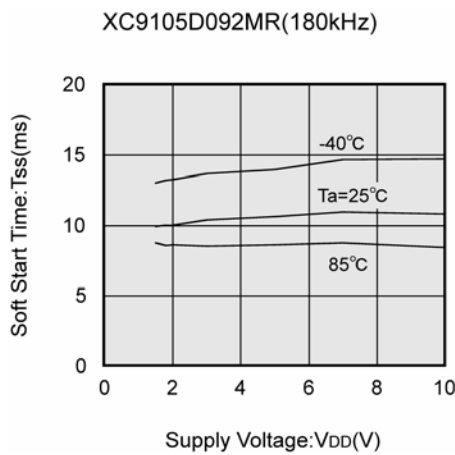

(13) CE "H" "L" Voltage vs. Power Supply Voltage

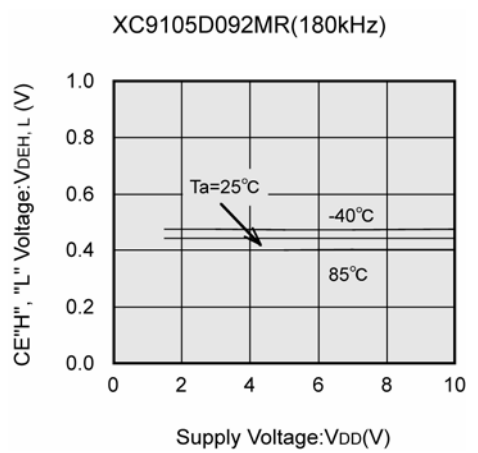

(14) PWM "H" "L" Voltage vs. Power Supply Voltage

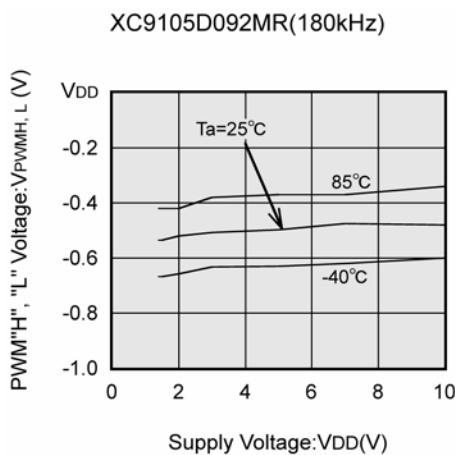

(15) EXT "H" On Resistance vs. Power Supply Voltage

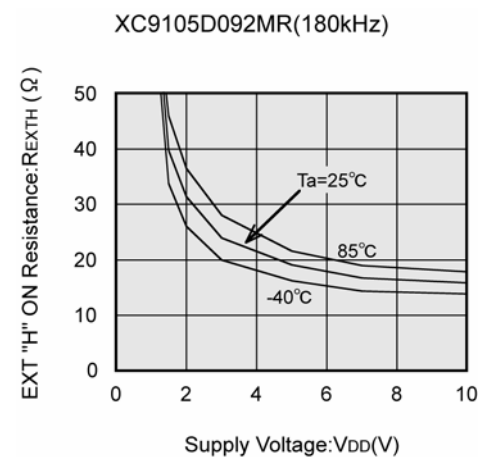

TYPICAL PERFORMANCE CHARACTERISTICS (Continued)

(16) EXT "L" On Resistance vs. Power Supply Voltage

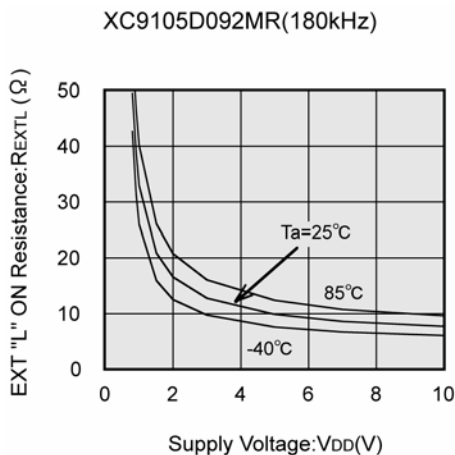

(17) Operation Start Voltage vs. Ambient Temperature

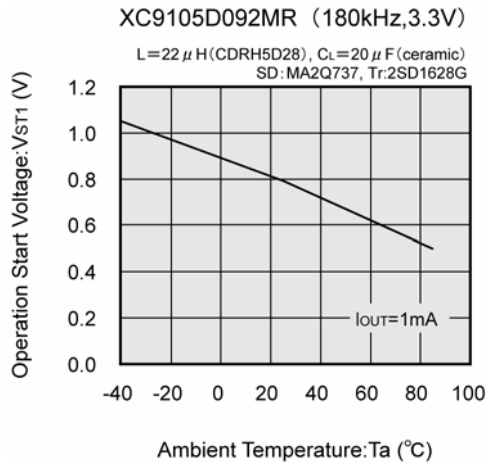

(18) Operation Hold Voltage vs. Ambient Temperature

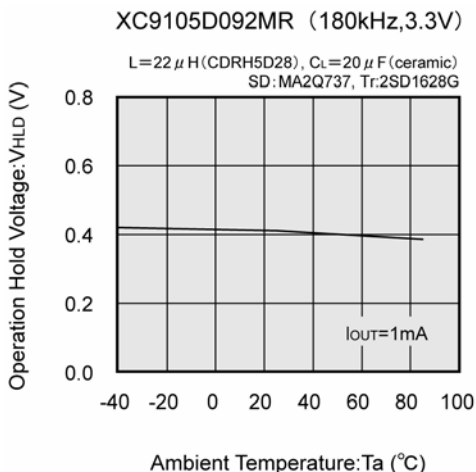

(19) Oscillation Start Voltage vs. Ambient Temperature

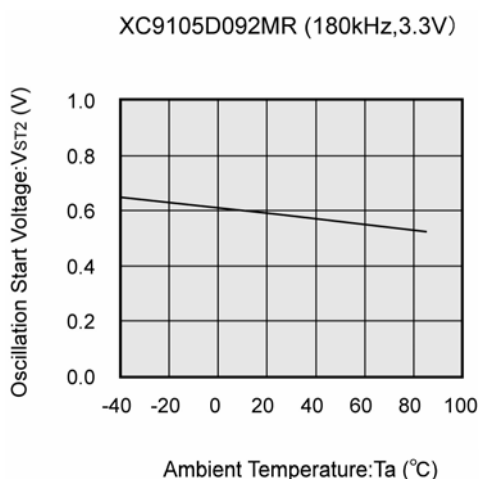

(20) Supply Current 1 vs. Power Supply Voltage

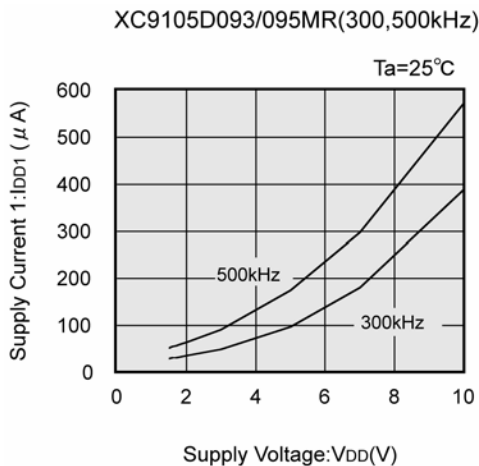

(21) Supply Current 2 vs. Power Supply Voltage

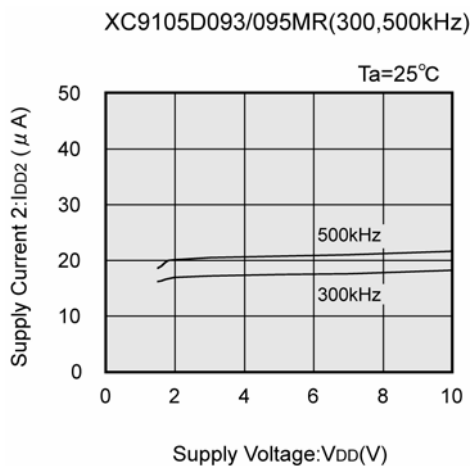

TYPICAL PERFORMANCE CHARACTERISTICS (Continued)

(22) Oscillation Frequency vs. Power Supply Voltage

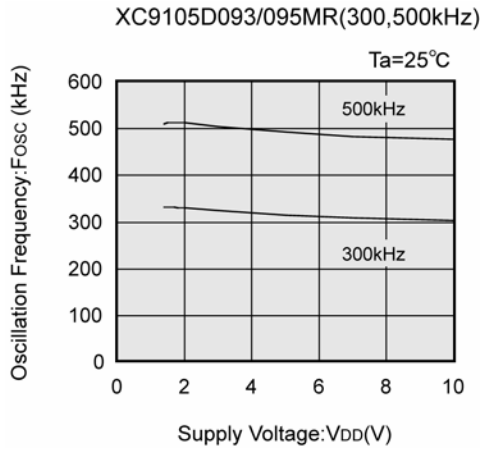

(23) Maximum Duty Cycle vs. Power Supply Voltage

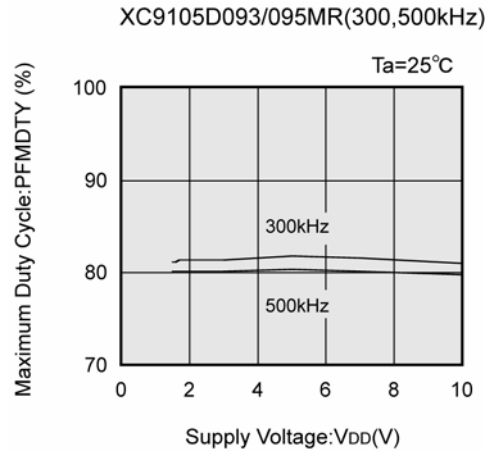

(24) PFM Duty Ratio vs. Power Supply Voltage

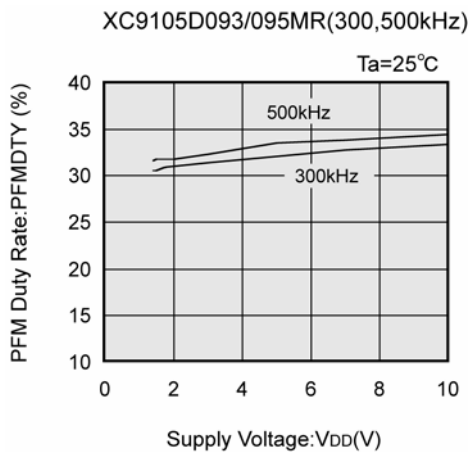

PACKAGING INFORMATION

SOT-25

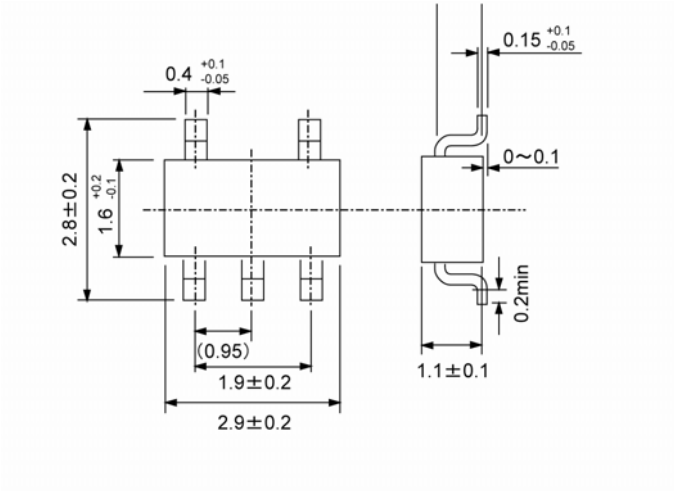

USP-6B

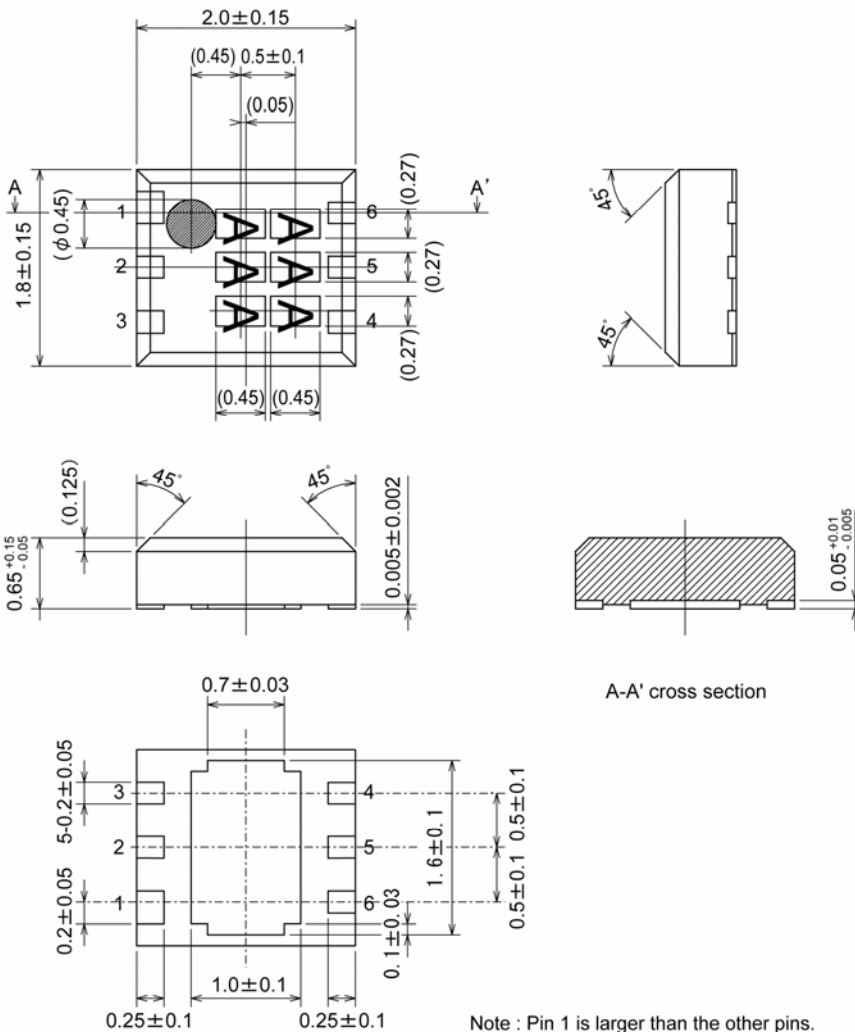

PACKAGING INFORMATION (Continued)

USP-6B Recommended Pattern Layout

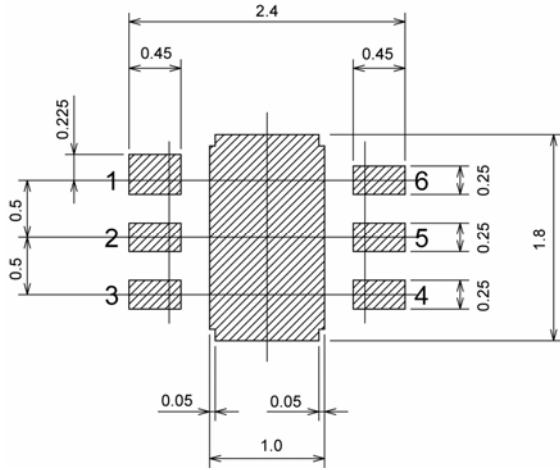

USP-6B Recommended Metal Mask Design

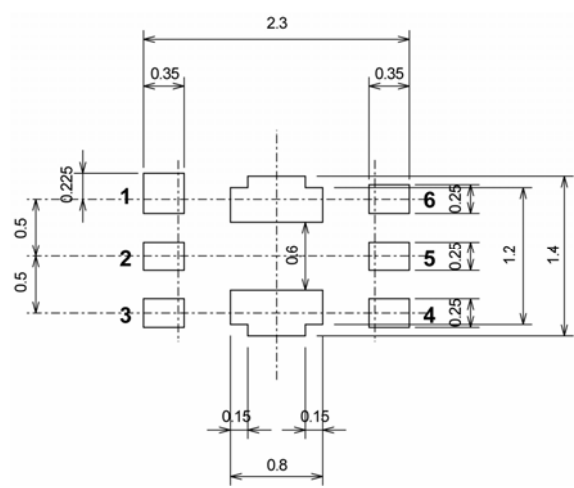

MARKING RULE

SOT-25

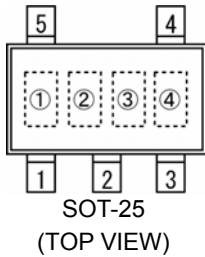

Represents product series

MARK	PRODUCT SERIES
3	XC9103x09xMx
4	XC9104x09xMx
5	XC9105x09xMx

Represents current limit function

MARK	FUNCTIONS	PRODUCT SERIES
B	With current limit function	XC9103/9104/9105B09xMx
D	Without current limit function	XC9103/9104/9105D09xMx

Represents oscillation frequency

MARK	OSCILLATION FREQUENCY	PRODUCT SERIES
1	100	XC9103/9104/9105x091Mx
2	180	XC9103/9104/9105x092Mx
3	300	XC9103/9104/9105x093Mx
5	500	XC9103/9104/9105x095Mx

Represents production lot number

0 to 9 and A to Z, reversed character of 0 to 9 and A to Z repeated.
(G, I, J, O, Q, W excepted)

USP-6B

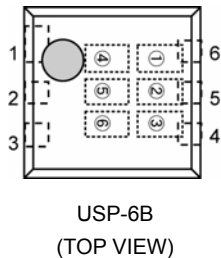

Represents product series

MARK	PRODUCT SERIES
6	XC9103x09xDx
Y	XC9104x09xDx
9	XC9105x09xDx

Represents current limit function

MARK	FUNCTIONS	PRODUCT SERIES
B	With current limit function	XC9103/9104/9105B09xDx
D	Without current limit function	XC9103/9104/9105D09xDx

Represents FB voltage value

MARK		FB VOLTAGE	PRODUCT SERIES
0	9	09	XC9103/9104/9105x09xDx

Represents oscillation frequency

MARK	OSCILLATION FREQUENCY	PRODUCT SERIES
1	100	XC9103/9104/9105x091Dx
2	180	XC9103/9104/9105x092Dx
3	300	XC9103/9104/9105x093Dx
5	500	XC9103/9104/9105x095Dx

Represents production lot number

0 to 9 and A to Z repeated. (G, I, J, O, Q, W excepted)
Note: No character inversion used.

1. The products and product specifications contained herein are subject to change without notice to improve performance characteristics. Consult us, or our representatives before use, to confirm that the information in this catalog is up to date.
2. We assume no responsibility for any infringement of patents, patent rights, or other rights arising from the use of any information and circuitry in this catalog.
3. Please ensure suitable shipping controls (including fail-safe designs and aging protection) are in force for equipment employing products listed in this catalog.
4. The products in this catalog are not developed, designed, or approved for use with such equipment whose failure of malfunction can be reasonably expected to directly endanger the life of, or cause significant injury to, the user.
(e.g. Atomic energy; aerospace; transport; combustion and associated safety equipment thereof.)
5. Please use the products listed in this catalog within the specified ranges.
Should you wish to use the products under conditions exceeding the specifications, please consult us or our representatives.
6. We assume no responsibility for damage or loss due to abnormal use.
7. All rights reserved. No part of this catalog may be copied or reproduced without the prior permission of Torex Semiconductor Ltd.

TOREX SEMICONDUCTOR LTD.