

RoHS Compliant Product

DIP-8

Description

The SPWLM393D consists of two independent voltage comparators, designed specifically to operate from a single power over a wide voltage range.

Features

- * Input Common-Mode Voltage Range Includes Ground
- * Output Compatible With TTL, DTL, and CMOS Logic System
- * Low Input Bias Current $I_{bias}=25nA(Typ.)$
- * Low Supply Current Drain $I_{CC}=0.8mA(Typ.)$
- * Single Or Dual Supply Operation
- * Wide Operating Supply Range ($V_{CC}=2V\sim 36V$ or ± 1 to $\pm 18V$)

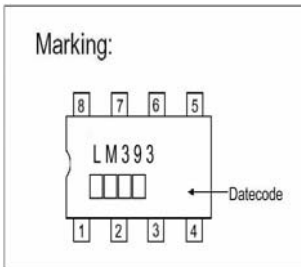
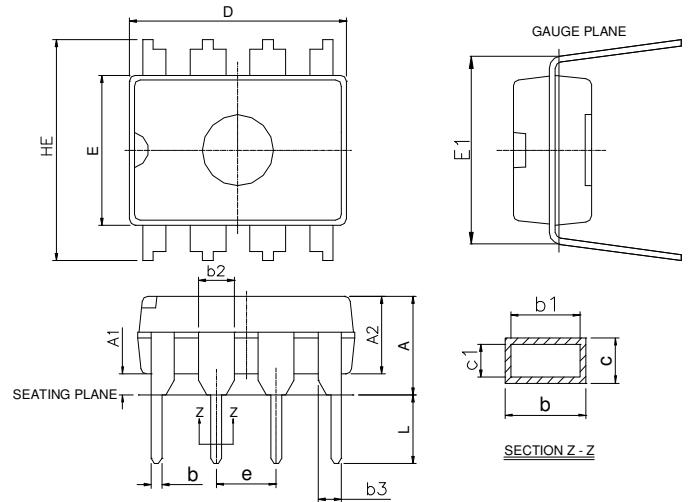

REF.	Millimeter		REF.	Millimeter	
	Min.	Max.		Min.	Max.
A	-	0.5334	c1	0.203	0.279
A1	0.381	-	D	9.017	10.16
A2	2.921	4.953	E	6.096	7.112
b	0.356	0.559	E1	7.620	8.255
b1	0.356	0.508	e	2.540 BSC	
b2	1.143	1.778	HE	-	10.92
b3	0.762	1.143	L	2.921	3.810
c	0.203	0.356			

Pin Configurations

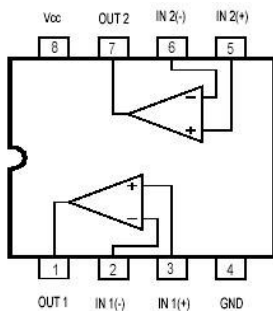

Block Diagram

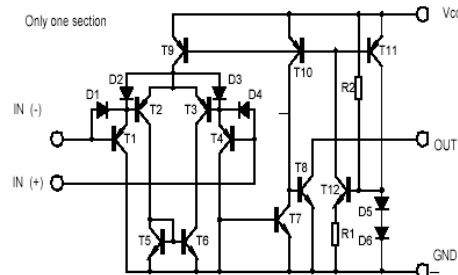

Absolute Maximum Ratings at Ta = 25°C

Parameter	Symbol	VALUE	Unit
Supply Voltage	Vcc	±18 or 36	V
Differential Input Voltage	VIDiff	36	V
Input voltage	VI	-0.3~36	V
Power Dissipation	PD	570	mW
Operating Temperature	Topr	0~+70	°C
Storage Temperature	Tstg	-65 to 150	°C

Electrical Characteristics (Vcc=5V, Ta=25°C, RT=10k, All voltage referenced to GND unless otherwise specified)

Parameter	SYMBOL	Test Conditions	MIN	Typ.	Max.	Unit
Input Offset Voltage	VIO	VCM=0 TO Vcc -1.5 Vo(p) = 1.4V, Rs=0		±1.0	±5.0	mV
Input Offset Current	IIO			±5	±50	nA
Input Bias Current	Ib			65	250	nA
Input Common-Mode Voltage Range	VI(R)		0		Vcc-1.5	V
Supply Current	Icc	RL=∞		0.6	1.0	mA
		RL=∞, Vcc=30V		0.8	2.5	mA
Large Signal Voltage Gain	Gv	Vcc=15V, RL>15KΩ	50	200		V/mV
Large Signal Response Time	tres	Vi=TTL logic wing Vref=1.4V, VRL=5V, RL=5.1 KΩ		350		ns
Response Time	tres	VRL=5V, RL=5.1KΩ		1400		ns
Output Sink Current	Iisink	Vi(-)>1V, Vi(+)=0V, Vo(p)<1.5V	6	18		mA
Output Saturation Voltage	Vsat	Vi(-)>1V, Vi(+)=0V, Iisink=4mA		160	400	mV
Output Leakage Current	Ileakage	VI(+)=1V, VI(-)=0				
		Vo(p)=5V		0.1		nA
		Vo(p)=30V			1.0	uA

Characteristics Curve

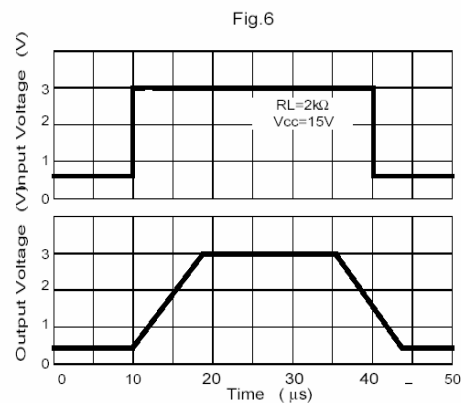
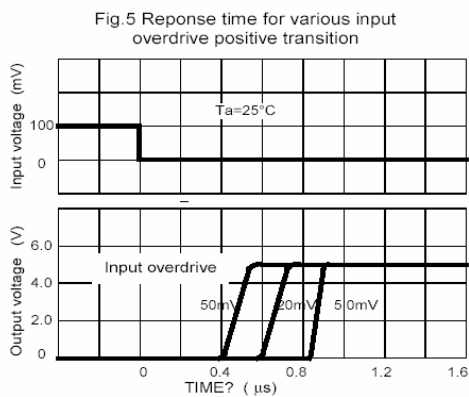
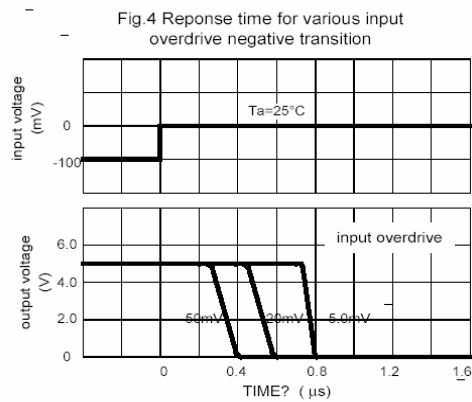
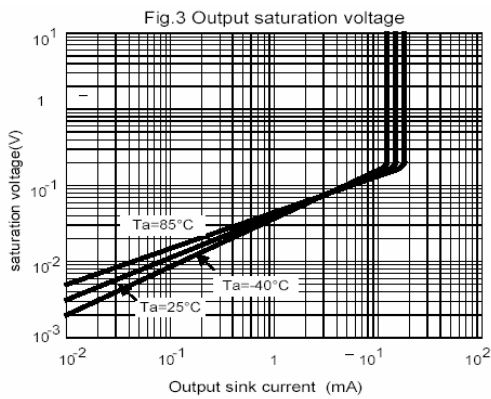
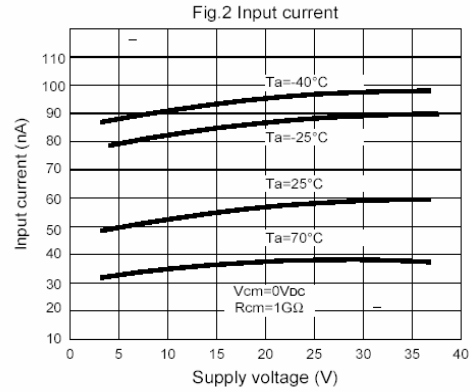
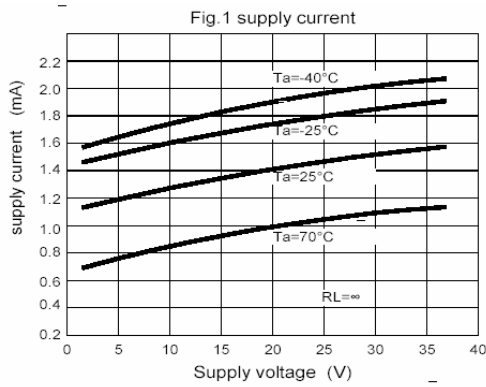

Fig.7 voltage Follower pulse response (small signal)

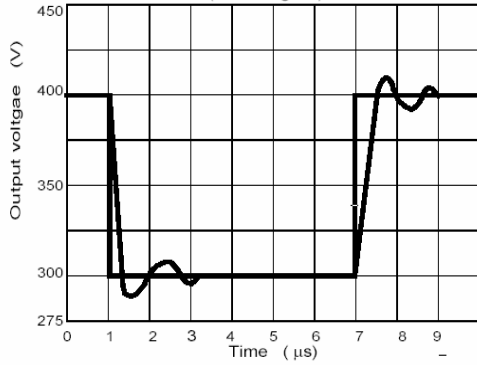

Fig.8 Large signal Frequency Response

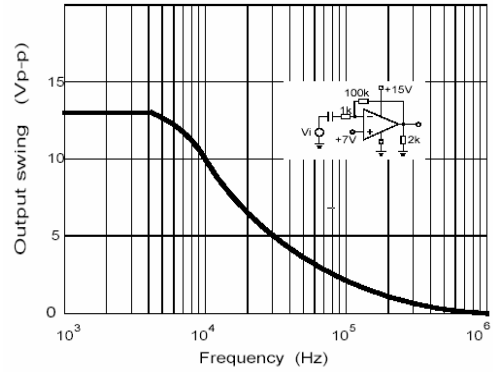

Fig.9 Output Characteristics current sourcing

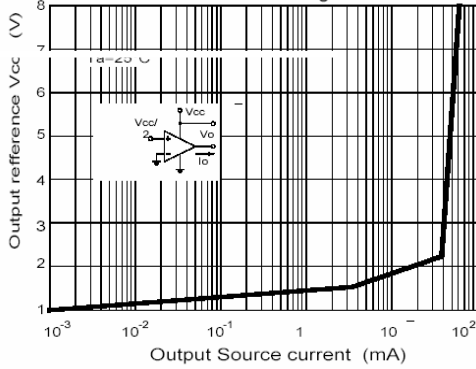

Fig.10 Output Characteristics Current sinking

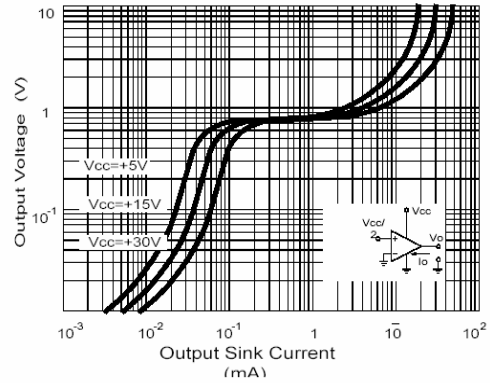

Fig.11 Current Limiting

