

## IGBT Module PSHI 50/06\*

### H-Bridge Configuration

Short Circuit SOA Capability  
Square RBSOA

$I_{C25} = 42.5 \text{ A}$   
 $V_{CES} = 600 \text{ V}$   
 $V_{CE(sat)typ.} = 2.4 \text{ V}$

Preliminary Data Sheet

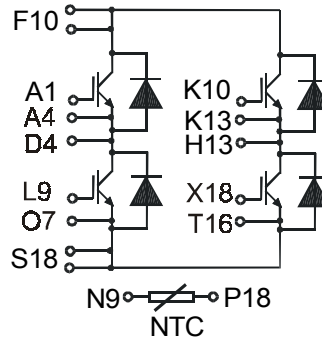

PSHI 50/06\*

\*NTC optional

### IGBTs

Symbol	Conditions	Maximum Ratings	
$V_{CES}$	$T_{VJ} = 25^{\circ}\text{C to } 150^{\circ}\text{C}$	600	V
$V_{GES}$		$\pm 20$	V
$I_{C25}$	$T_C = 25^{\circ}\text{C}$	42.5	A
$I_{C80}$	$T_C = 80^{\circ}\text{C}$	29	A
$I_{CM}$ $V_{CEK}$	$V_{GE} = \pm 15 \text{ V}; R_G = 33 \Omega; T_{VJ} = 125^{\circ}\text{C}$ RBSOA, Clamped inductive load; $L = 100 \mu\text{H}$	60	A
$t_{SC}$ (SCSOA)		$V_{CE} = V_{CES}; V_{GE} = \pm 15 \text{ V}; R_G = 33 \Omega; T_{VJ} = 125^{\circ}\text{C}$ non-repetitive	10
$P_{tot}$	$T_C = 25^{\circ}\text{C}$	130	W

Symbol	Conditions	Characteristic Values ( $T_{VJ} = 25^{\circ}\text{C}$ , unless otherwise specified)			
		min.	typ.	max.	
$V_{CE(sat)}$	$I_C = 50 \text{ A}; V_{GE} = 15 \text{ V}; T_{VJ} = 25^{\circ}\text{C}$ $T_{VJ} = 125^{\circ}\text{C}$		2.4 2.9	V V	
$V_{GE(th)}$	$I_C = 0.7 \text{ mA}; V_{GE} = V_{CE}$	4.5		6.5 V	
$I_{CES}$	$V_{CE} = V_{CES}; V_{GE} = 0 \text{ V}; T_{VJ} = 25^{\circ}\text{C}$ $T_{VJ} = 125^{\circ}\text{C}$			0.6 mA 1.7 mA	
$I_{GES}$	$V_{CE} = 0 \text{ V}; V_{GE} = \pm 20 \text{ V}$			100 nA	
$t_{d(on)}$ $t_r$ $t_{d(off)}$ $t_f$ $E_{on}$ $E_{off}$	Inductive load, $T_{VJ} = 125^{\circ}\text{C}$ $V_{CE} = 300 \text{ V}; I_C = 30 \text{ A}$ $V_{GE} = 15/0 \text{ V}; R_G = 33 \Omega$		50 50 270 40	ns ns ns ns	
				1.4 1.0	mJ mJ
$C_{ies}$		$V_{CE} = 25 \text{ V}; V_{GE} = 0 \text{ V}; f = 1 \text{ MHz}$		16	nF
$R_{thJC}$ $R_{thJH}$		(per IGBT) with heatsink compound (0.42 K/m.K; 50 $\mu\text{m}$ )		1.92	0.96 K/W K/W

**Caution:** These Devices are sensitive to electrostatic discharge. Users should observe proper ESD handling precautions.

### Features

- NPT IGBT technology
- low saturation voltage
- low switching losses
- square RBSOA, no latch up
- high short circuit capability
- positive temperature coefficient for easy paralleling
- MOS input, voltage controlled
- ultra fast free wheeling diodes
- solderable pins for PCB mounting
- package with copper base plate
- Isolation voltage 3000 V~
- UL registered, E 148688

### Advantages

- space and weight savings
- reduced protection circuits
- package designed for wave soldering
- High power density
- Easy to mount with two screws

### Typical Applications

- motor control
  - DC motor armature winding
  - DC motor excitation winding
  - synchronous motor excitation winding
- supply of transformer primary winding
  - power supplies
  - welding
  - X-ray
  - UPS
  - battery charger

### Reverse diodes (FRED)

Symbol	Conditions	Maximum Ratings	
$I_{F25}$	$T_C = 25^\circ\text{C}$	30	A
$I_{F80}$	$T_C = 80^\circ\text{C}$	19	A

Symbol	Conditions	Characteristic Values		
		min.	typ.	max.
$V_F$	$I_F = 30\text{ A}; T_{VJ} = 25^\circ\text{C}$ $T_{VJ} = 125^\circ\text{C}$	2.57	2.84	V
$I_{RM}$ $t_{rr}$	$I_F = 15\text{ A}; di_F/dt = 400\text{ A}/\mu\text{s}; T_{VJ} = 125^\circ\text{C}$ $V_R = 300\text{ V}; V_{GE} = 0\text{ V}$	7		A
		50		ns
$R_{thJC}$ $R_{thJH}$	with heatsink compound (0.42 K/m.K; 50 $\mu\text{m}$ )	4.6		2.3 K/W K/W

### Temperature Sensor NTC

Symbol	Conditions	Characteristic Values		
		min.	typ.	max.
$R_{25}$	$T = 25^\circ\text{C}$	455	470	485 k $\Omega$
$B_{25/50}$			3474	K

### Module

Symbol	Conditions	Maximum Ratings	
$T_{VJ}$		-40...+150	$^\circ\text{C}$
$T_{stg}$		-40...+150	$^\circ\text{C}$
$V_{ISOL}$	$I_{ISOL} \leq 1\text{ mA}; 50/60\text{ Hz}$	3000	V~
$M_d$	Mounting torque (M4)	1.5 - 2.0 14 - 18	Nm lb.in.
$a$	Max. allowable acceleration	50	$\text{m/s}^2$

Symbol	Conditions	Characteristic Values		
		min.	typ.	max.
$d_s$	Creepage distance on surface (Pin to heatsink)	11.2		mm
$d_A$	Strike distance in air (Pin to heatsink)	11.2		mm
Weight		24		g

### Package style and outline

Dimensions in mm (1mm = 0.0394")

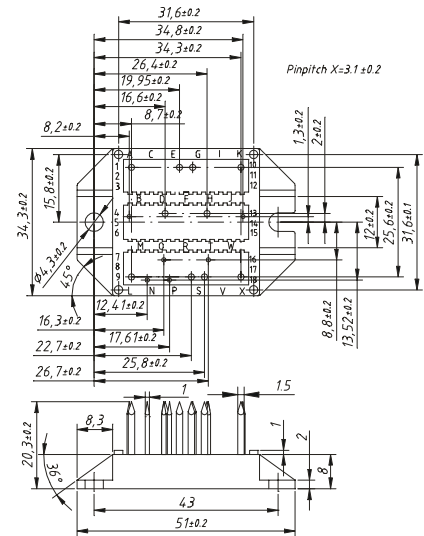

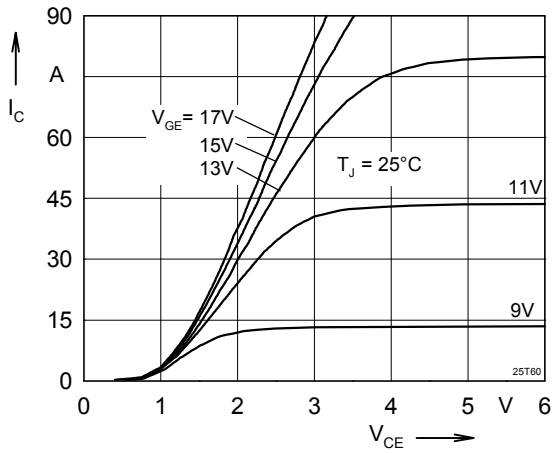

Fig. 1 Typ. output characteristics

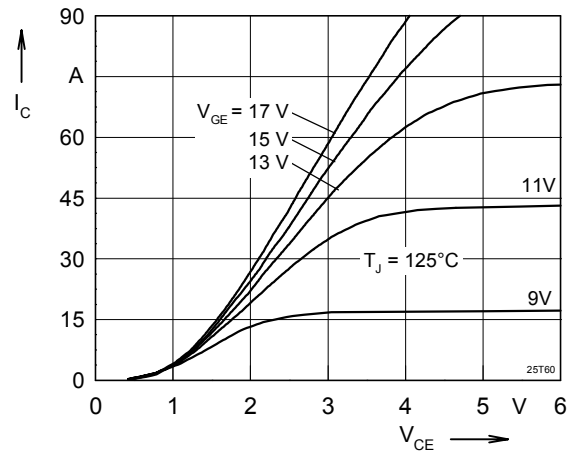

Fig. 2 Typ. output characteristics

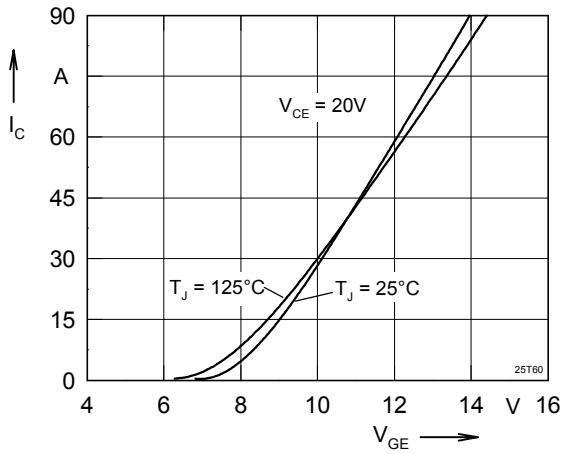

Fig. 3 Typ. transfer characteristics

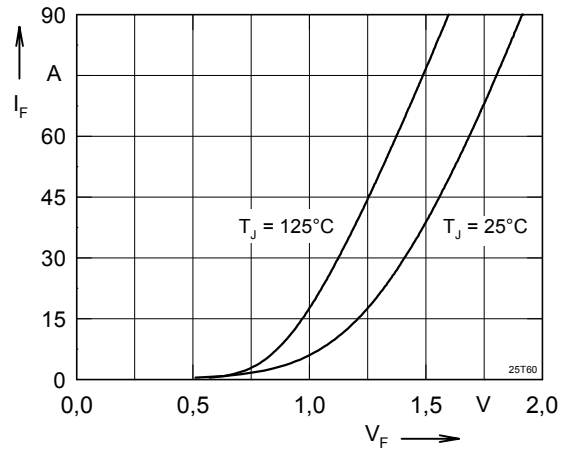

Fig. 4 Typ. forward characteristics of free wheeling diode

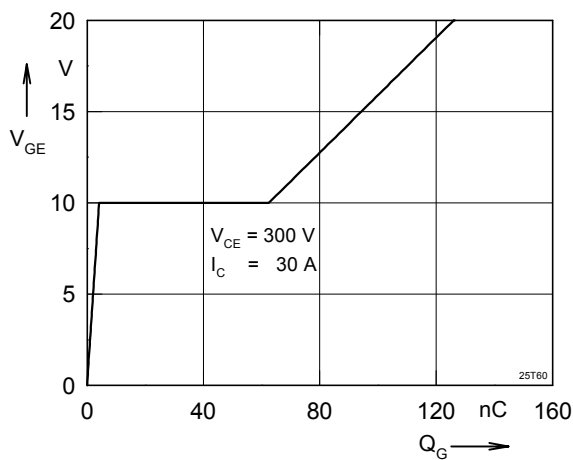

Fig. 5 Typ. turn on gate charge

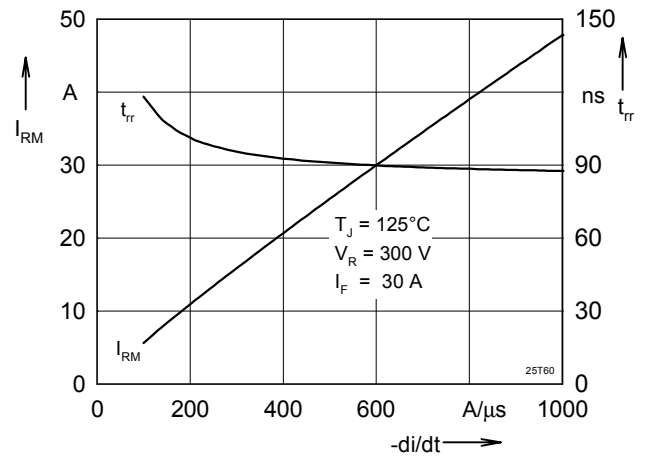

Fig. 6 Typ. turn off characteristics of free wheeling diode

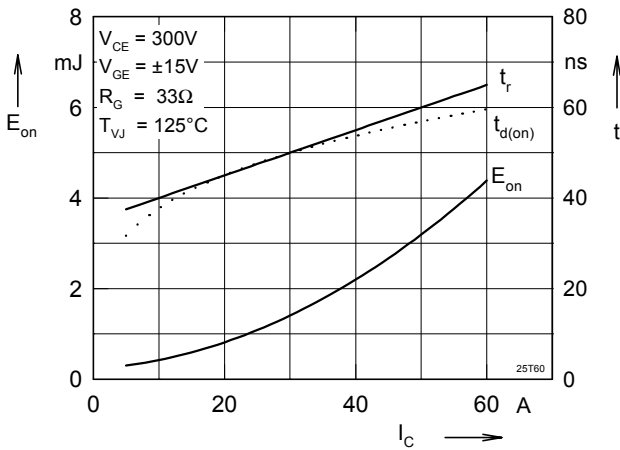

Fig. 7 Typ. turn on energy and switching

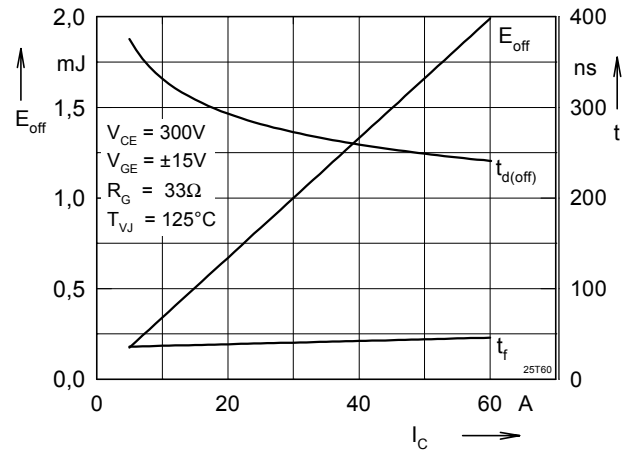

Fig. 8 Typ. turn off energy and switching times versus collector current

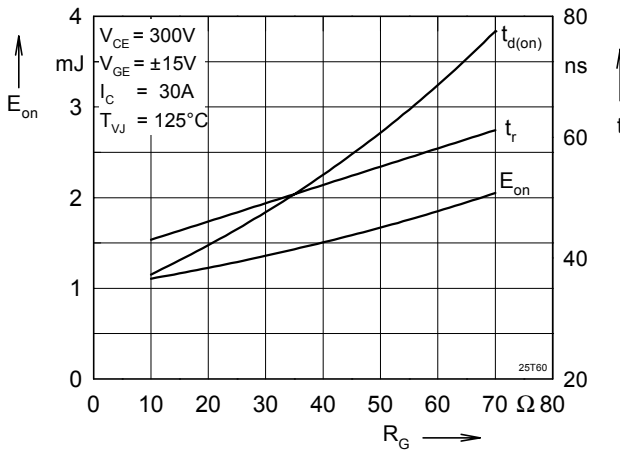

Fig. 9 Typ. turn on energy and switching

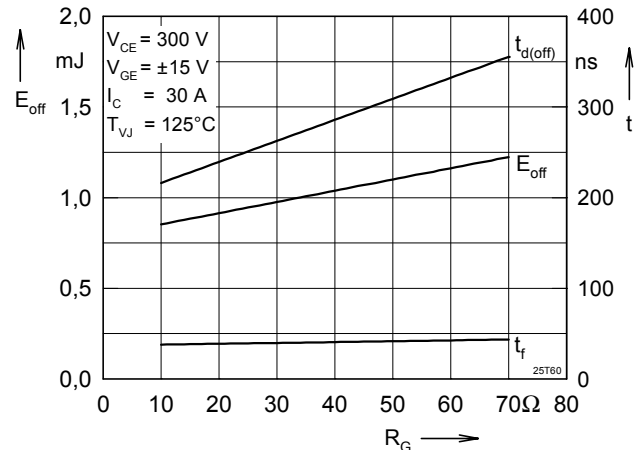

Fig. 10 Typ. turn off energy and switching times versus gate resistor

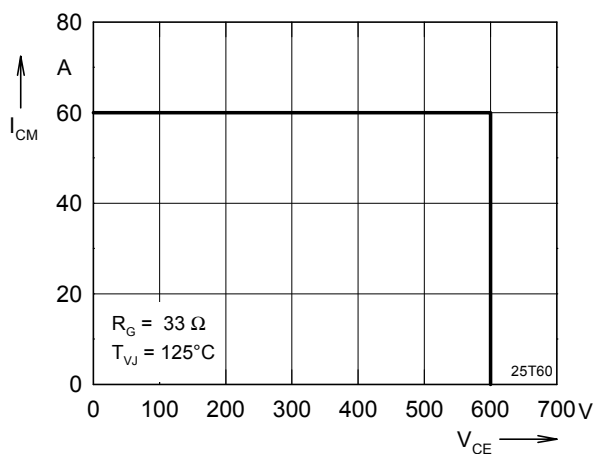

Fig. 11 Reverse biased safe operating area

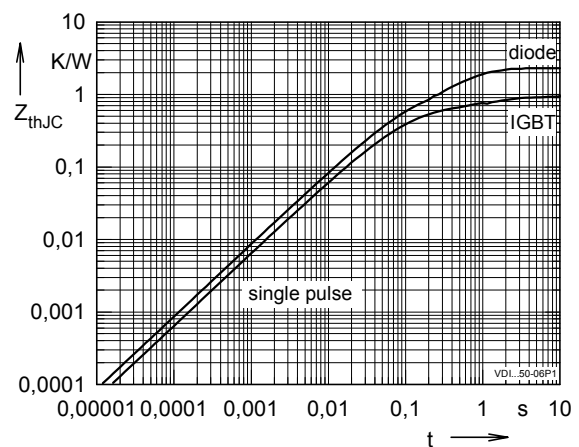

Fig. 12 Typ. transient thermal impedance RBSOA