



Ideal Diode, Reverse-Battery, and Overvoltage Protection Switch/Limiter Controllers with External MOSFETs

MAX16914/MAX16915

General Description

The MAX16914/MAX16915 low-quiescent-current overvoltage and reverse-battery protection controllers are designed for automotive and industrial systems that must tolerate high-voltage transient and fault conditions. These conditions include load dumps, voltage dips, and reversed input voltages. The controllers monitor the input voltage on the supply line and control two external pFETs to isolate the load from the fault condition. The external pFETs are turned on when the input supply exceeds 4.5V and stay on up to the programmed overvoltage threshold. During high-voltage fault conditions, the controllers regulate the output voltage to the set upper threshold voltage (MAX16915), or switch to high resistance (MAX16914) for the duration of the overvoltage transient to prevent damage to the downstream circuitry. The overvoltage event is indicated through an active-low, open-drain output, \overline{OV} .

The reverse-battery pFET behaves as an ideal diode, minimizing the voltage drop when forward biased. Under reverse bias conditions, the pFET is turned off, preventing a downstream tank capacitor from being discharged into the source.

Shutdown control turns off the IC completely, disconnecting the input from the output and disconnecting TERM from its external resistor-divider to reduce the quiescent current to a minimum.

Both devices are available in a 10-pin μ MAX[®] package and operate over the automotive -40°C to +125°C temperature range.

Applications

Automotive
Industrial

Pin Configuration

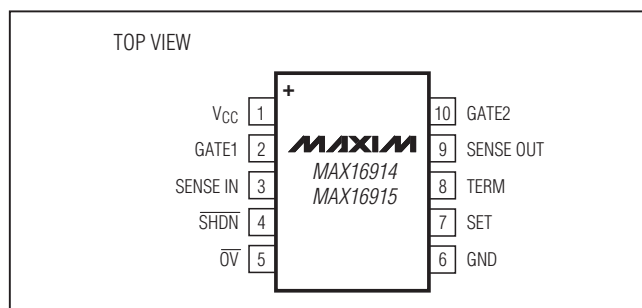

μ MAX is a registered trademark of Maxim Integrated Products, Inc.

Features

- ◆ 4.5V to 19V Input Voltage Operation
- ◆ Transient Voltage Protection Up to +44V and -75V
- ◆ Adjustable Overvoltage Limit with Resistor-Divider Shut Off in Shutdown
- ◆ Ideal Diode Reverse-Battery Protection
- ◆ Low Voltage Drop When Used with Properly Sized External pFETs
- ◆ Back-Charge Prevention
- ◆ Overvoltage Indicator
- ◆ Shutdown Input
- ◆ 29 μ A Low Operating Current
- ◆ 6 μ A Low Shutdown Current
- ◆ Thermal-Overload Protection
- ◆ -40°C to +125°C Operating Temperature Range
- ◆ Small 10-Pin μ MAX Package
- ◆ AEC-Q100 Qualified

Ordering Information

PART	TEMP RANGE	PIN-PACKAGE
MAX16914AUB/V+	-40°C to +125°C	10 μ MAX
MAX16915AUB/V+	-40°C to +125°C	10 μ MAX

+ Denotes a lead(Pb)-free/RoHS-compliant package.

/V denotes an automotive qualified device.

Typical Operating Circuit

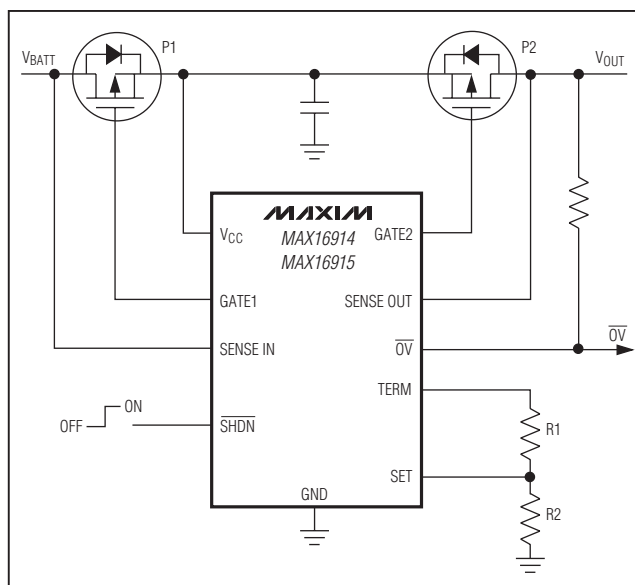

Maxim Integrated Products 1

For pricing, delivery, and ordering information, please contact Maxim Direct at 1-888-629-4642, or visit Maxim's website at www.maxim-ic.com.

Ideal Diode, Reverse-Battery, and Overvoltage Protection Switch/Limiter Controllers with External MOSFETs

MAX16914/MAX16915

ABSOLUTE MAXIMUM RATINGS

V _{CC} , SENSE OUT, TERM, $\overline{\text{SHDN}}$, $\overline{\text{OV}}$ to GND for $\leq 400\text{ms}$	-0.3V to +44V	GATE1, GATE2 to GND	-0.3V to (V _{CC} + 0.3V)
V _{CC} , SENSE OUT, TERM, $\overline{\text{SHDN}}$, $\overline{\text{OV}}$ to GND for $\leq 90\text{s}$	-0.3V to +28V	SET to GND	-0.3V to +8V
V _{CC} , SENSE OUT, TERM, $\overline{\text{SHDN}}$, $\overline{\text{OV}}$ to GND	-0.3V to +20V	Continuous Power Dissipation (T _A = +70°C)	
SENSE IN to GND for $\leq 2\text{ms}$	-75V to +44V	10-Pin μMAX (derate 8.8mW/°C above T _A = +70°C)	
SENSE IN to GND for $\leq 90\text{s}$	-18V to +44V	(Note 1).....	707mW
SENSE IN to GND	-0.3V to +20V	Operating Temperature Range	-40°C to +125°C
GATE1, GATE2 to V _{CC}	-16V to +0.3V	Junction Temperature	+150°C
		Storage Temperature Range.....	-65°C to +150°C
		Lead Temperature (soldering, 10s)	+300°C

Note 1: Package thermal resistances were obtained using the method described in JEDEC specification JESD51-7, using a four-layer board. For detailed information on package thermal considerations, refer to www.maxim-ic.com/thermal-tutorial.

Stresses beyond those listed under "Absolute Maximum Ratings" may cause permanent damage to the device. These are stress ratings only, and functional operation of the device at these or any other conditions beyond those indicated in the operational sections of the specifications is not implied. Exposure to absolute maximum rating conditions for extended periods may affect device reliability.

ELECTRICAL CHARACTERISTICS

(V_{CC} = 14V, C_{GATE1} = 32nF, C_{GATE2} = 32nF, $\overline{\text{SHDN}}$ = high, T_A = -40°C to +125°C, unless otherwise noted. Typical values are at T_A = +25°C.) (Note 2)

PARAMETER	SYMBOL	CONDITIONS	MIN	TYP	MAX	UNITS
Operating Voltage Range	V _{CC}	(Note 3)	4.5		19	V
Shutdown Supply Current (I _{SENSE IN} + I _{SENSE OUT} + I _{OV} + I $\overline{\text{SHDN}}$ + I _{VCC})	I $\overline{\text{SHDN}}$	$\overline{\text{SHDN}}$ = low, V _{SENSE OUT} = 0V, V _{TERM} = 0V	T _A = +25°C	6.0	12	μA
			T _A = +85°C (Note 3)	6.1	12	
			T _A = +125°C (Note 3)	6.2	12	
Quiescent Supply Current (I _{SENSE IN} + I _{SENSE OUT} + I _{OV} + I $\overline{\text{SHDN}}$ + I _{VCC})	I _Q	$\overline{\text{SHDN}}$ = high	T _A = +25°C	29	53	μA
			T _A = +85°C (Note 3)	30	55	
			T _A = +125°C (Note 3)	31	57	
V _{CC} Undervoltage Lockout	V _{UVLO}	V _{CC} rising, V _{SET} = 1V, $\overline{\text{SHDN}}$ = high		4.06	4.35	V
V _{CC} Undervoltage-Lockout Hysteresis				8		%
SET Threshold Voltage	V _{SETTH}	V _{SET} rising	-3%	+1.20	+3%	V
SET Threshold Voltage Hysteresis	V _{SETHY}			4		%
SET Input Current	I _{SET}	V _{SET} = 1V		0.02	0.2	μA
$\overline{\text{SHDN}}$ Low Threshold	V $\overline{\text{SHDNL}}$				0.4	V
$\overline{\text{SHDN}}$ High Threshold	V $\overline{\text{SHDNH}}$		1.4			V
$\overline{\text{SHDN}}$ Pulldown Current	I $\overline{\text{SHDN}}$	V $\overline{\text{SHDN}}$ = 14V, internally pulled to GND		0.5	1.0	μA
V _{CC} to GATE Output Low Voltage	V _{GVCC1}	V _{CC} = 14V	6.25	7.5	8.5	V
V _{CC} to GATE Clamp Voltage	V _{GVCC2}	V _{CC} = 42V			14	V

Ideal Diode, Reverse-Battery, and Overvoltage Protection Switch/Limiter Controllers with External MOSFETs

ELECTRICAL CHARACTERISTICS (continued)

(V_{CC} = 14V, C_{GATE1} = 32nF, C_{GATE2} = 32nF, $\overline{\text{SHDN}}$ = high, T_A = -40°C to +125°C, unless otherwise noted. Typical values are at T_A = +25°C.) (Note 2)

PARAMETER	SYMBOL	CONDITIONS	MIN	TYP	MAX	UNITS
TERM On-Resistance	R _{TERM}	$\overline{\text{SHDN}}$ = high		150	500	Ω
TERM Output Current	I _{TERM}	$\overline{\text{SHDN}}$ = low, V _{TERM} = 0V			1.0	μA
Back-Charge Voltage Fault Threshold	V _{BCTH}	V _{SENSE OUT} = 14V (Note 4)	18	25	32	mV
Back-Charge Voltage Threshold Hysteresis	V _{BCHY}	V _{SENSE OUT} = 14V		50		mV
Back-Charge Turn-Off Time (GATE1)	t _{BC}	V _{CC} = 9.5V, V _{SENSE IN} = 9V, V _{SENSE OUT} stepped from 4.9V to 9.5V (Note 5)		6	10	μs
Back-Charge Recovery Time (GATE1)	t _{BCREC}	V _{CC} = 9.5V, V _{SENSE IN} = 9V, V _{SENSE OUT} stepped from 9.5V to 4.9V (Note 6)		18	30	μs
GATE2 Turn-Off Time		V _{CC} = 9.5V, V _{SET} rising from 1V to 1.5V (Note 7)		3		μs
GATE2 Turn-On Time		V _{CC} = 9.5V, V _{SET} falling from 1.5V to 1V (Note 8)		20		μs
Startup Response Time ($\overline{\text{VSHDN}}$ Rising)	t _{START1}	V _{CC} = 9.5V, from $\overline{\text{VSHDN}}$ rising to V _{GATE_} falling (Note 9)		100		μs
Startup Response Time (V _{CC} Rising)	t _{START2}	V _{CC} rising from 2V to 4.5V, $\overline{\text{SHDN}}$ = high (Note 10)		0.150		ms
Reverse-Battery Voltage Turn-Off Time/UVLO Turn-Off Time	t _{REVERSE}	V _{CC} and V _{SENSE IN} falling from 4.25V to 3.25V, V _{SENSE OUT} = 4.25V (Note 11)			30	μs
Thermal-Shutdown Temperature				+170		°C
Thermal-Shutdown Hysteresis				20		°C
$\overline{\text{OV}}$ Output Low Voltage	V _{OVBL}	I _{SINK} = 600μA			0.4	V
$\overline{\text{OV}}$ Open-Drain Leakage Current	I _{OVB}	V _{SET} = 1.0V			1.0	μA
SENSE IN Input Current	I _{SENSE IN}	$\overline{\text{VSHDN}}$ = 0/14V		1	5	μA
SENSE OUT Input Current	I _{SENSE OUT}	$\overline{\text{VSHDN}}$ = 0/14V		2	5	μA
SET to $\overline{\text{OV}}$ Output Low Propagation Delay	t _{OVBPD}	V _{CC} = 9.5V, V _{SET} rising from 1V to 1.5V to $\overline{\text{OV}}$ falling		3		μs

Note 2: All parameters are production tested at T_A = +25NC. Limits over the operating temperature range are guaranteed by design and characterization.

Note 3: Guaranteed by design and characterization.

Note 4: The back-charge voltage, V_{BC}, is defined as the voltage at SENSE OUT minus the voltage at SENSE IN.

Note 5: Defined as the time from when V_{BC} exceeds V_{BCTH} (25mV typ) to when V_{GATE1} exceeds V_{CC} - 3.5V.

Note 6: Defined as the time from when V_{BC} falls below V_{BCTH} - 50mV to when V_{GATE1} falls below V_{CC} - 3.5V.

Note 7: Defined as the time from when V_{SET} exceeds V_{SETTH} (1.20V typ) to when V_{GATE2} exceeds V_{CC} - 3.5V.

Note 8: Defined as the time from when V_{SET} falls below V_{SETTH} - 5% (1.14V typ) to when V_{GATE2} falls below V_{CC} - 3.5V.

Note 9: The external pFETs can turn on t_{START} after the IC is powered up and all input conditions are valid.

Note 10: Defined as the time from when V_{CC} exceeds the undervoltage-lockout threshold (4.3V max) to when V_{GATE1} and V_{GATE2} fall below 1V.

Note 11: Defined as the time from when V_{CC} falls below V_{SENSE OUT} - 25mV to when V_{GATE1} reaches V_{CC} - 1.75V.

Ideal Diode, Reverse-Battery, and Overvoltage Protection Switch/Limiter Controllers with External MOSFETs

Typical Operating Characteristics

($V_{CC} = 14V$, $V_{SHDN} = 14V$, MAX16914/MAX16915 Evaluation Kit, $T_A = +25^\circ C$, unless otherwise noted.)

SUPPLY CURRENT vs. SUPPLY VOLTAGE

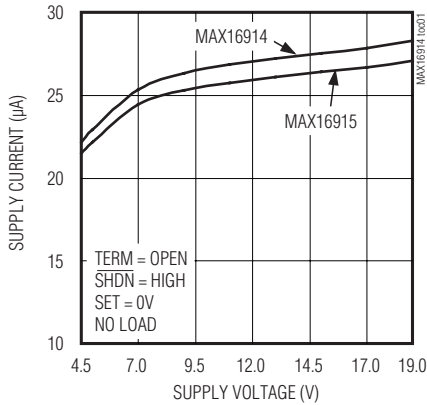

SUPPLY CURRENT vs. TEMPERATURE

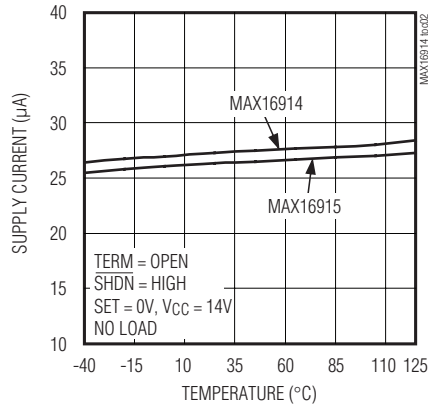

SHUTDOWN SUPPLY CURRENT vs. SUPPLY VOLTAGE

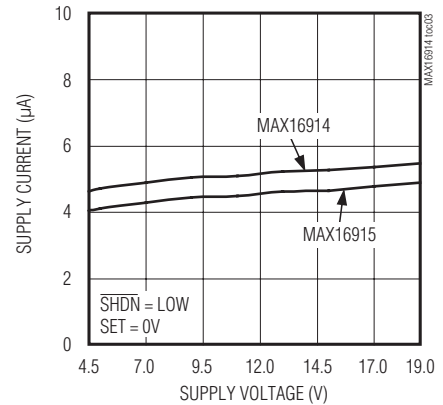

UVLO THRESHOLD vs. TEMPERATURE

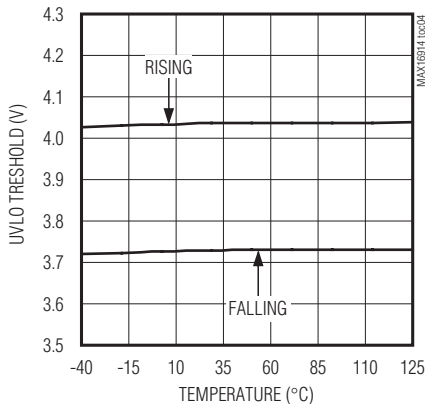

SET THRESHOLD vs. TEMPERATURE

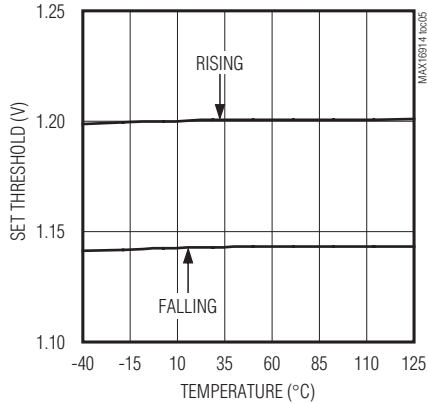

POWER-UP RESPONSE

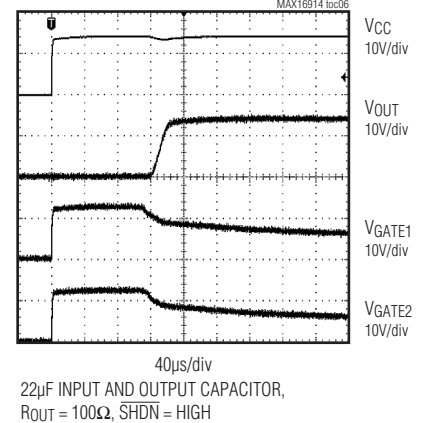

STARTUP FROM SHUTDOWN RESPONSE

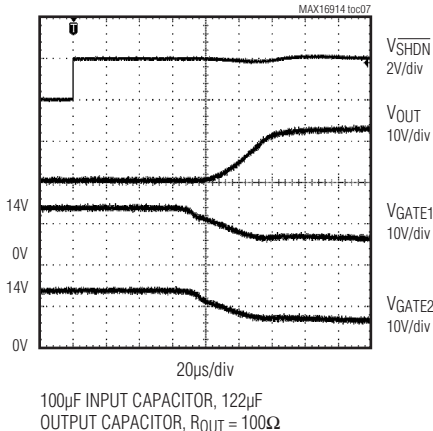

OVERVOLTAGE LIMITER RESPONSE (MAX16915)

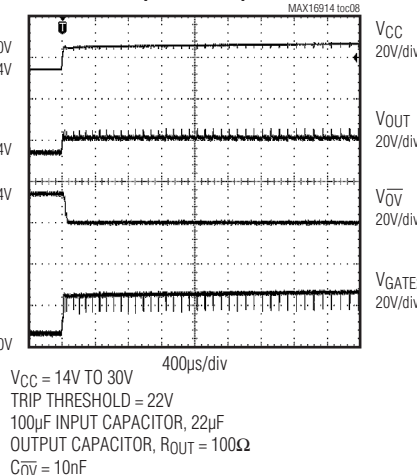

OVERVOLTAGE SWITCH-OFF RESPONSE (MAX16914)

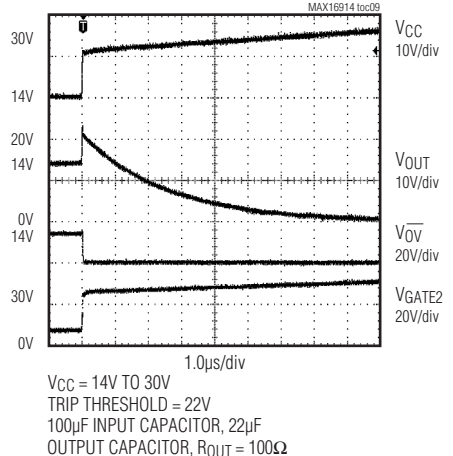

Ideal Diode, Reverse-Battery, and Overvoltage Protection Switch/Limiter Controllers with External MOSFETs

Typical Operating Characteristics (continued)

($V_{CC} = 14V$, $\overline{V_{SHDN}} = 14V$, MAX16914/MAX16915 Evaluation Kit, $T_A = +25^\circ C$, unless otherwise noted.)

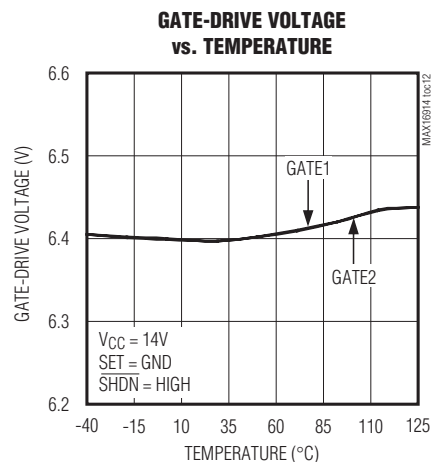
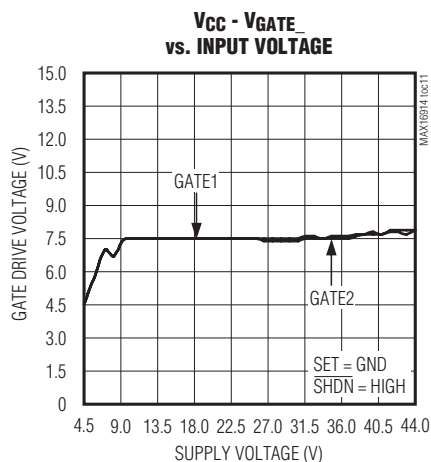
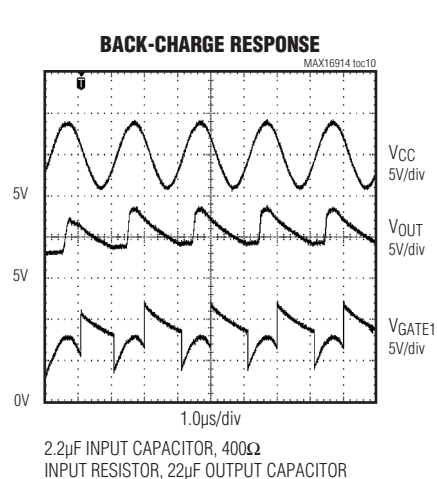

MAX16914/MAX16915

Pin Description

PIN	NAME	FUNCTION
1	V_{CC}	Positive Supply Input Voltage. Bypass V_{CC} to GND with a 0.1µF or greater ceramic capacitor.
2	GATE1	Gate-Driver Output. Connect GATE1 to the gate of an external p-channel FET pass switch to provide low drain-to-source voltage drop, reverse voltage protection, and back-charge prevention.
3	SENSE IN	Differential Voltage Sense Input (Input Side of IC). Used with SENSE OUT to provide back-charge prevention when the SENSE IN voltage falls below the SENSE OUT voltage by 25mV.
4	\overline{SHDN}	Active-Low Shutdown/Wake Input. Drive \overline{SHDN} high to turn on the voltage detectors. GATE2 is shorted to V_{CC} when \overline{SHDN} is low. \overline{SHDN} is internally pulled to GND through a 0.5µA current sink. Connect \overline{SHDN} to V_{CC} for always-on operation.
5	\overline{OV}	Open-Drain Overvoltage Indicator Output. Connect a pullup resistor from \overline{OV} to a positive supply such as V_{CC} . \overline{OV} is pulled low when the voltage at SET exceeds the internal threshold.
6	GND	Ground
7	SET	Controller Overvoltage Threshold Programming Input. Connect SET to the center of an external resistive divider network between TERM and GND to adjust the desired overvoltage switch-off or limiter threshold.
8	TERM	Voltage-Divider Termination Output. TERM is internally connected to SENSE OUT in the MAX16915 and to V_{CC} in the MAX16914. TERM is high impedance when \overline{SHDN} is low, forcing the current to zero in the resistor-divider connected to TERM.
9	SENSE OUT	Differential Voltage Sense Input (Output Side Of IC). Used with SENSE IN to provide back-charge prevention when the SENSE IN voltage falls below the SENSE OUT voltage by 25mV.
10	GATE2	Gate-Driver Output. Connect GATE2 to the gate of an external p-channel FET pass switch. GATE2 is driven low during normal operation and quickly regulated or shorted to V_{CC} during an overvoltage condition. GATE2 is shorted to V_{CC} when \overline{SHDN} is low.

Ideal Diode, Reverse-Battery, and Overvoltage Protection Switch/Limiter Controllers with External MOSFETs

Functional Diagram

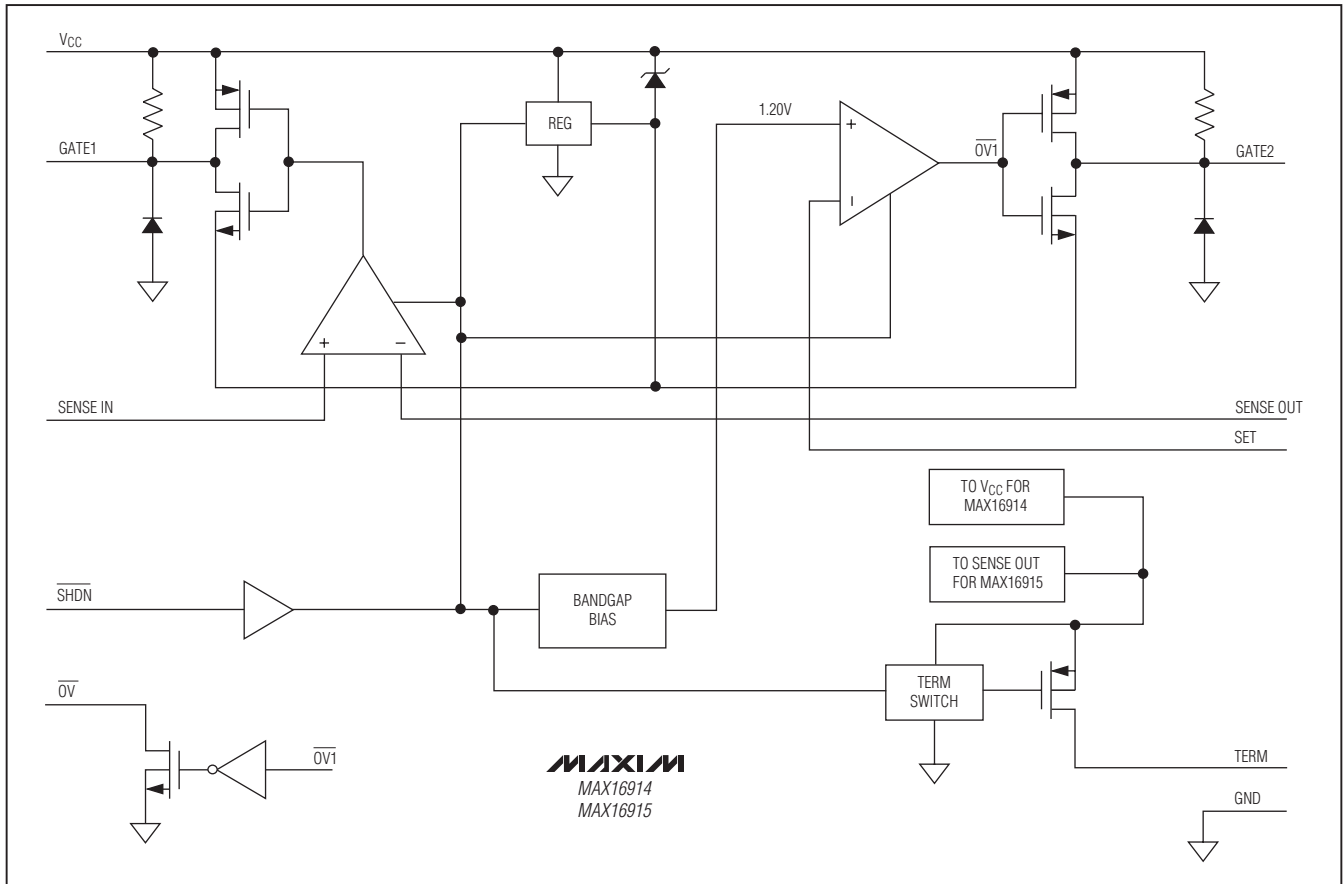

Detailed Description

The MAX16914/MAX16915 are ultra-small, low-quiescent, high load-current, overvoltage-protection circuits for automotive or industrial applications. These devices monitor the input and output voltages and control two p-channel MOSFETs to protect downstream loads from reverse-battery, overvoltage, and high-voltage transient conditions and prevent downstream tank capacitors from discharging into the source (back-charging).

One MOSFET (P1) eliminates the need for external diodes, thus minimizing the input voltage drop and provides back-charge and reverse-battery protection. The second MOSFET (P2) isolates the load or regulates the output voltage during an overvoltage condition. These ICs allow system designers to size the external p-channel MOSFET to their load current, voltage drop, and board size.

Overvoltage Switch-Off Controller (MAX16914)

In the MAX16914, the input voltage is monitored (TERM is internally shorted to VCC—see the *Functional Diagram*) making the device an overvoltage switch-off controller. As the VCC voltage rises, and the programmed overvoltage threshold is tripped, the internal fast comparator turns off the external p-channel MOSFET (P2), pulling GATE2 to VCC to disconnect the power source from the load. When the monitored voltage goes below the adjusted overvoltage threshold, the MAX16914 enhances GATE2, reconnecting the load to the power source.

Ideal Diode, Reverse-Battery, and Overvoltage Protection Switch/Limiter Controllers with External MOSFETs

MAX16914/MAX16915

Overvoltage Limiter Controller (MAX16915)

In the MAX16915, TERM is internally connected to SENSE OUT (see the *Functional Diagram*) allowing the IC to operate in voltage-limiter mode.

During normal operation, GATE2 is pulled low to fully enhance the MOSFET. The external MOSFET's drain voltage is monitored through a resistor-divider between TERM, SET, and GND. When the output voltage rises above the adjusted overvoltage threshold, an internal comparator pulls GATE2 to VCC turning off P2. When the monitored voltage goes below the overvoltage threshold (-4% hysteresis), the p-channel MOSFET (P2) is turned on again. During a continuous overvoltage condition, MOSFET (P2) cycles on and off (between the overvoltage threshold and the hysteresis), generating a sawtooth waveform with a frequency dependent on the load capacitance and load current. This process continues to keep the voltage at the output regulated to within approximately a 4% window. The output voltage is regulated during the overvoltage transients and MOSFET (P2) continues to conduct during the overvoltage event, operating in switched-linear mode.

Caution must be exercised when operating the MAX16915 in voltage-limiting mode for long durations due to the MOSFET's power-dissipation consideration (see the *MOSFET Selection* section).

Shutdown

The MAX16914/MAX16915 feature an active-low shutdown input (SHDN). Drive SHDN low to switch off FET (P2), disconnecting the input from the output, thus placing the IC in low-quiescent-current mode. Reverse-battery protection is still maintained.

Reverse-Battery Protection

The MAX16914/MAX16915 feature reverse-battery protection to prevent damage to the downstream circuitry caused by battery reversal or negative transients. The reverse-battery protection blocks the flow of current into the downstream load and allows the circuit designer to remove series-protection diodes.

Back-Charge Switch-Off

The MAX16914/MAX16915 monitor the input-to-output differential voltage between SENSE IN and SENSE OUT. It turns off the external FET (P1) when $(V_{SENSE\ OUT} - V_{SENSE\ IN}) > 25mV$ (see Figure 1) to prevent discharging of a downstream tank capacitor into the battery supply during an input voltage drop, such as a cold-crank condition or during a superimposed sinusoidal voltage on top of the supply voltage. It turns on the FET (P1) again if the back-charge voltage threshold hysteresis of 50mV is satisfied.

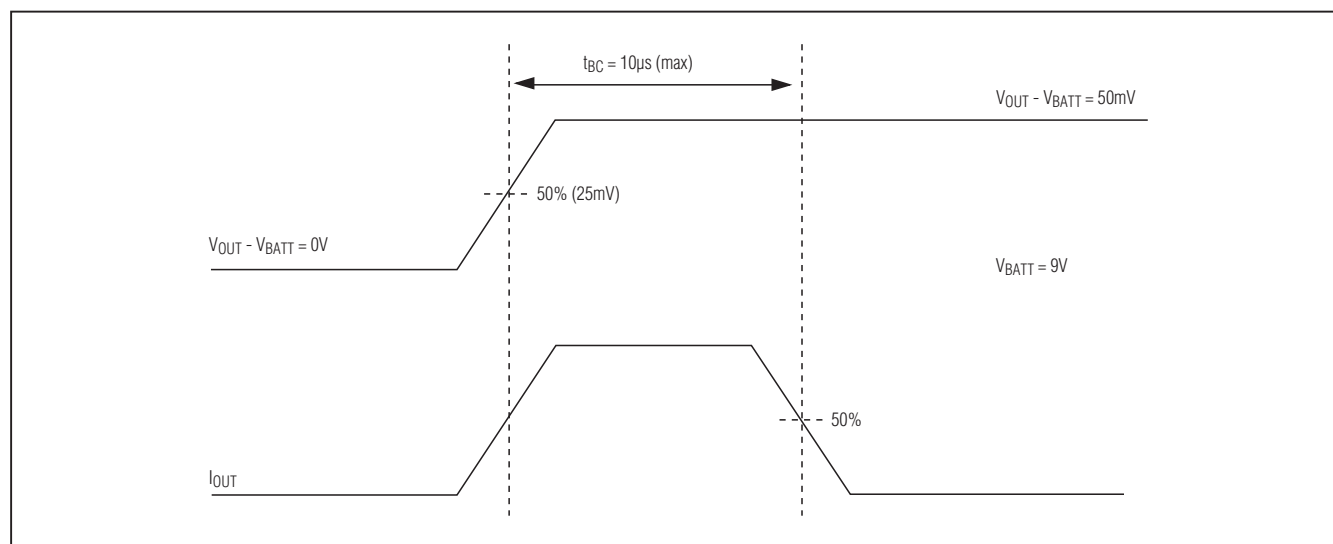

Figure 1. Back-Charge Turn-Off Time

Ideal Diode, Reverse-Battery, and Overvoltage Protection Switch/Limiter Controllers with External MOSFETs

Overvoltage Indicator Output (\overline{OV})

The MAX16914/MAX16915 include an active-low, open-drain overvoltage-indicator output (\overline{OV}). For the MAX16914, \overline{OV} asserts low when V_{CC} exceeds the programmed overvoltage threshold. \overline{OV} deasserts when the overvoltage condition is over.

For the MAX16915, \overline{OV} asserts if V_{OUT} exceeds the programmed overvoltage threshold. \overline{OV} deasserts when V_{OUT} drops 4% (typ) below the overvoltage threshold level. If the overvoltage condition continues, \overline{OV} may toggle with the same frequency as the overvoltage limiter FET (P2). If the P2 device is turned on for a very short period (less than t_{OVBPD}), the \overline{OV} pin may not toggle. To obtain a logic-level output, connect a 45k Ω pullup resistor from \overline{OV} to a system voltage less than 44V. A capacitor connected from \overline{OV} to GND helps extend the time that the logic level remains low.

Applications Information

Load Dump

Most automotive applications run off a multicell “12V” lead-acid battery with a nominal voltage that swings between 9V and 16V (depending on load current, charging status, temperature, battery age, etc.). The battery voltage is distributed throughout the automobile and is locally regulated down to voltages required by the different system modules. Load dump occurs when the alternator is charging the battery and the battery becomes disconnected. The alternator voltage regulator is temporarily driven out of control. Power from the alternator flows into the distributed power system and elevates the voltage seen at each module. The voltage spikes have rise times typically greater than 5ms and decays within several hundred milliseconds but can extend out to 1s or more depending on the characteristics of the charging system. These transients are capable of destroying sensitive electronic equipment on the first “fault event.”

Setting Overvoltage Thresholds

TERM and SET provide an accurate means to set the overvoltage level for the MAX16914/MAX16915. Use a resistive divider to set the desired overvoltage condition (see the *Typical Operating Circuit*). V_{SET} has a rising 1.20V threshold with a 4% falling hysteresis. Begin by selecting the total end-to-end resistance:

$$R_{TOTAL} = R1 + R2$$

For high accuracy, choose R_{TOTAL} to yield a total current equivalent to a minimum $100 \times I_{SET}$ where I_{SET} is the input bias current at SET.

For example:

With an overvoltage threshold (V_{OV}) set to 20V, $R_{TOTAL} < 20V/(100 \times I_{SET})$, where $I_{SET} = 1\mu A$ (max).

$$R_{TOTAL} < 200k\Omega$$

Use the following formula to calculate R2:

$$R2 = (V_{TH} \times R_{TOTAL})/V_{OV}$$

where V_{TH} is the 1.20V SET rising threshold and V_{OV} is the desired overvoltage threshold.

Then, $R2 = 12.0k\Omega$.

Use the nearest standard-value resistor lower than the calculated value. A lower value for total resistance dissipates more power but provides slightly better accuracy.

To determine R1:

$$R_{TOTAL} = R2 + R1$$

Then, $R1 = 188k\Omega$.

Use the nearest standard-value resistor lower than the calculated value. A lower value for total resistance dissipates more power but provides slightly better accuracy.

MOSFET Selection

Output p-Channel MOSFET (P2)

Select the external output MOSFET according to the application current level. The MOSFET's on-resistance ($R_{DS(ON)}$) should be chosen low enough to have a minimum voltage drop at full load to limit the MOSFET power dissipation. Determine the device power rating to accommodate an overvoltage fault when operating the MAX16915 in overvoltage-limiting mode. During normal operation for either IC, the external MOSFET dissipates little power. The power dissipated in the MOSFET during normal operation is:

$$P_{NORM} = I_{LOAD}^2 \times R_{DS(ON)}$$

where P_{NORM} is the power dissipated in the MOSFET in normal operation, I_{LOAD} is the output load current, and $R_{DS(ON)}$ is the drain-to-source resistance of the MOSFET. Worst-case power dissipation in the output MOSFET occurs during a prolonged overvoltage event when operating the MAX16915 in voltage-limiting mode. The power dissipated across the MOSFET is as follows:

$$P_{OVLO} = V_{DS} \times I_{LOAD}$$

where P_{OVLO} is the power dissipated in the MOSFET in overvoltage-limiting operation, V_{DS} is the voltage across the MOSFET's drain and source, and I_{LOAD} is the load current.

Ideal Diode, Reverse-Battery, and Overvoltage Protection Switch/Limiter Controllers with External MOSFETs

MAX16914/MAX16915

Reverse-Polarity Protection MOSFET (P1)

Most battery-powered applications must include reverse-voltage protection. Many times this is implemented with a diode in series with the battery. The disadvantage in using a diode is the forward-voltage drop of the diode, which reduces the operating voltage available to downstream circuits ($V_{LOAD} = V_{BATTERY} - V_{DIODE}$).

The MAX16914/MAX16915 include high-voltage GATE1 drive circuitry allowing users to replace the high-voltage drop series diode with a low-voltage-drop MOSFET device (as shown in the *Typical Operating Circuit*). The forward-voltage drop is reduced to $I_{LOAD} \times R_{DS(ON)}$ of P1. With a suitably chosen MOSFET, the voltage drop can be reduced to millivolts.

In normal operating mode, internal GATE1 output circuitry enhances P1. The constant enhancement ensures P1 operates in a low $R_{DS(ON)}$ mode, but the gate-source junction is not overstressed during high battery-voltage applications or transients (many MOSFET devices specify a $\pm 20V$ V_{GS} absolute maximum). As V_{CC} drops below 10V, GATE1 is limited to GND, reducing P1 V_{GS} to V_{CC} . In normal operation, the P1 power dissipation is very low:

$$P1 = I_{LOAD}^2 \times R_{DS(ON)}$$

During reverse-battery conditions, GATE1 is limited to GND and the P1 gate-source junction is reverse biased. P1 is turned off and neither the MAX16914/MAX16915 nor the load circuitry is exposed to the reverse-battery voltage. Care should be taken to place P1 (and its internal drain-to-source diode) in the correct orientation for proper reverse-battery operation.

Thermal Shutdown

The MAX16914/MAX16915 thermal-shutdown feature turns off both MOSFETs if the IC junction temperature exceeds the maximum allowable thermal dissipation. When the junction temperature exceeds $T_J = +170^\circ\text{C}$, the thermal sensor signals the shutdown logic, turning off both GATE1 and GATE2 outputs and allowing the device to cool. The thermal sensor turns GATE1 and GATE2 on again after the IC's junction temperature cools by 20°C . For continuous operation, do not exceed the absolute maximum junction-temperature rating of $T_J = +150^\circ\text{C}$.

Chip Information

PROCESS: BiCMOS

Package Information

For the latest package outline information and land patterns, go to www.maxim-ic.com/packages.

PACKAGE TYPE	PACKAGE CODE	DOCUMENT NO.
10 μ MAX	U10+2	21-0061

Maxim cannot assume responsibility for use of any circuitry other than circuitry entirely embodied in a Maxim product. No circuit patent licenses are implied. Maxim reserves the right to change the circuitry and specifications without notice at any time.

Maxim Integrated Products, 120 San Gabriel Drive, Sunnyvale, CA 94086 408-737-7600 _____ 9