



PRODUCT SPECIFICATION

Model No:CST-S30320T9/S30321T9

Descriptions:

- 0.3 Inch Triad Digit SMD Display
- Emitting Color : Super Bright Yellow



CUSTOMER APPROVED SIGNATURES	APPROVED BY	CHECKED BY	PREPARED BY

CHINA SEMICONDUCTOR CORPORATION
Address:2FL. NO.909,Chung-Cheng Road,
Chung-Ho City Taipei Hsien,Taiwan.

Tel:886-2-2223-9696
Fax:886-2-2223-9377

OPTO PLUS TECHNOLOGIES CO.,LTD
Address:696 Shun jiang Rd.,Ji Shan St.Shaoxing,
ZheJiang,China

Tel:86-0575-88623888
Fax:86-0575-88623112



Model No : CST-S30320/S30321T9

Features -

1. 0.3 inch (7.62mm) digit height.
2. Qualified according to JEDEC moisture sensitivity Level 2a.
3. RoHS compliant.
4. Low power consumption.
5. Easy mounting on P.C. board.

Device Selection Guide -

Model No.	Chip		Description
	Material	Emitting Color	
CST-S30320T9	AlGaInP	Super Bright Yellow	Common Anode
CST-S30321T9	AlGaInP	Super Bright Yellow	Common Cathode

Mechanical Dimensions -

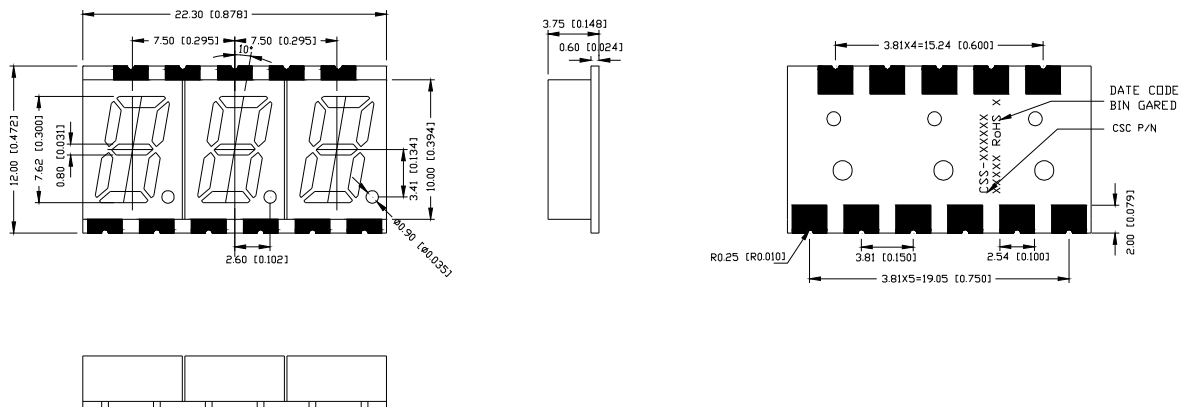

Notes:

All dimensions are in millimeters [inches], and tolerance is ± 0.25 [0.010] unless otherwise noted.



Model No : CST-S30320/S30321T9

Internal Circuit Diagrams -

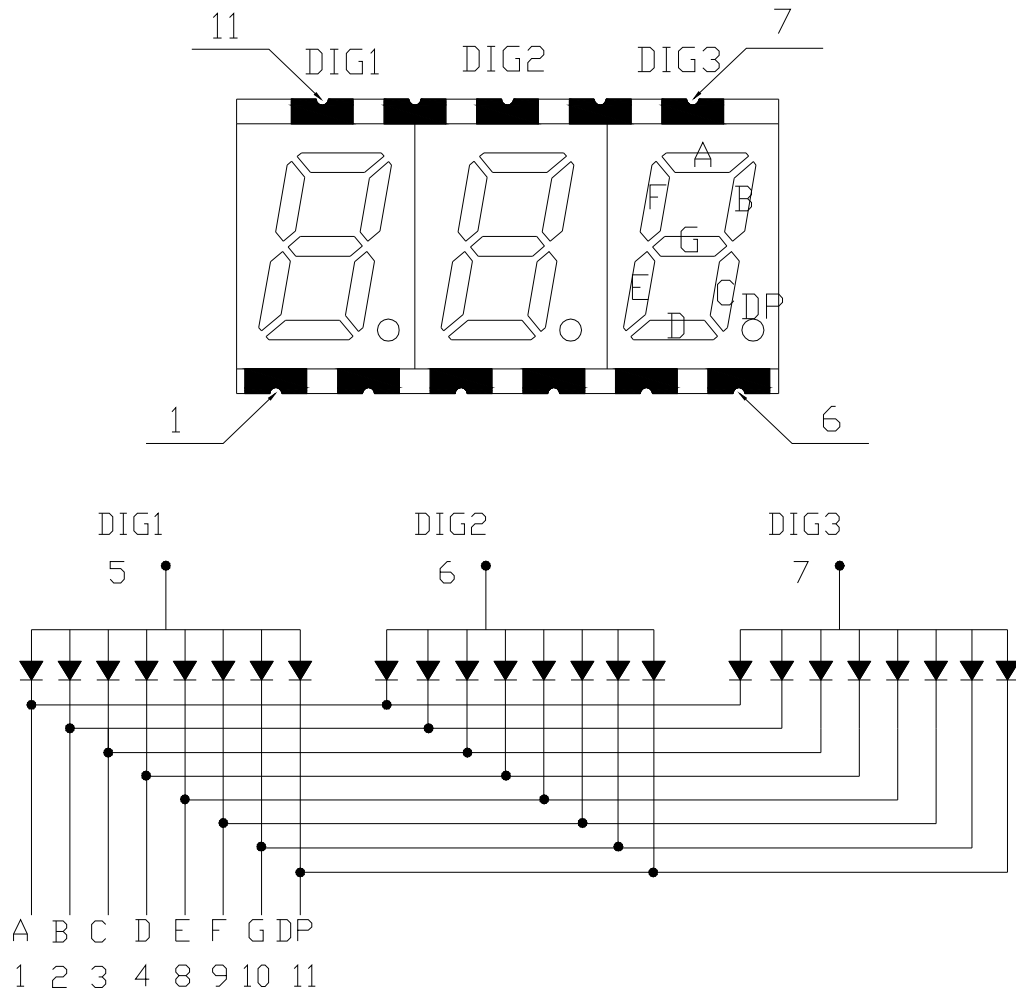

CST-S30320 Common Anode
(CST-S30321 Common Cathode)



Model No : CST-S30320/S30321T9

■ Absolute Maximum Rating -

(Ta=25°C)

Parameter	Symbol	Rating	Unit
Power Dissipation Per Dice	P _{AD}	70	mW
Continuous Forward Current Per Dice	I _{AF}	25	mA
Peak Current Per Dice(duty cycle 1/10,1KHz)	I _{PF}	90	mA
Derating Linear From 25°C Per Dice	-	0.33	mA/°C
Reverse Voltage Per Dice	V _R	5	V
Operating Temp.	T _{opr}	-40 ~ +105	°C
Storage Temp.	T _{stg}	-40 ~ +105	°C

■ Electro-optical Characteristics -

(Ta=25°C)

Parameter	Symbol	Min.	Typ.	Max.	Unit	Condition
Forward Voltage Per Segment	V _F	-	2.1	2.8	V	I _F =20mA
Luminous Intensity Per Segment	I _v	5	13	-	mcd	I _F =10mA
Peak Emission Wavelength	λ _P	-	592	-	nm	I _F =20mA
Spectrum Radiation Bandwidth	Δλ	-	20	-	nm	I _F =20mA
Reverse Current	I _R	-	-	100	μA	V _R =5V
Luminous Intensity Matching Ratio	I _{V-m}	-	-	2:1	-	I _F =10mA



Model No : CST-S30320/S30321T9

Typical Electrical / Optical Characteristics Curves -

(Ta = 25°C Unless Otherwise Noted)

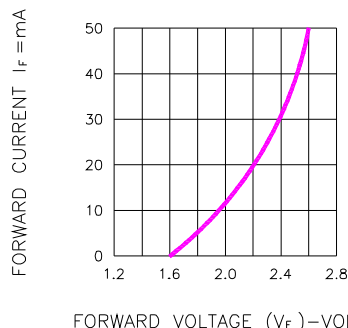

Fig.1 FORWARD CURRENT VS. FORWARD VOLTAGE

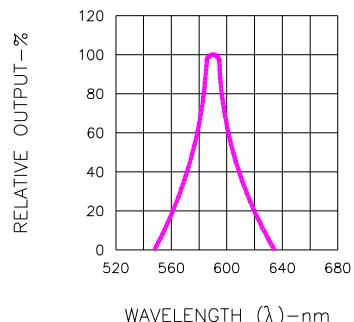

Fig.2 SPECTRAL RESPONSE

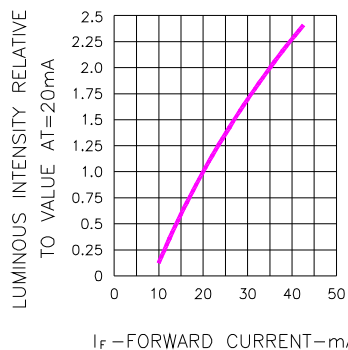

Fig.3 RELATIVE LUMINOUS INTENSITY VS. FORWARD CURRENT

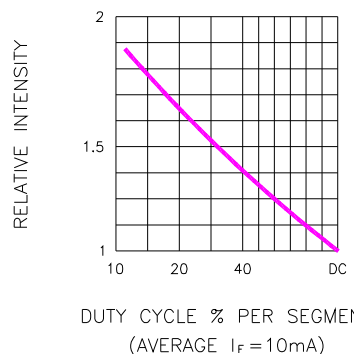

Fig.5 LUMINOUS INTENSITY VS. DUTY CYCLE

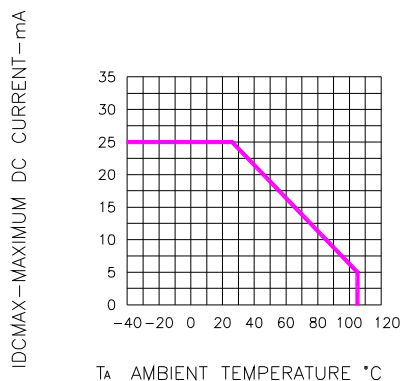

Fig.4 MAXIMUM ALLOWABLE DC CURRENT PER SEGMENT VS. A FUNCTION OF AMBIENT TEMPERATURE

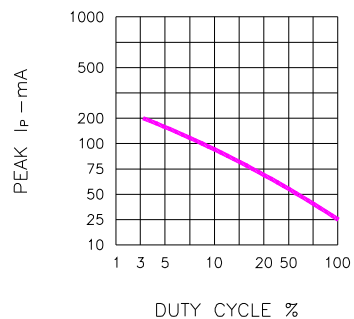

Fig.6 MAX PEAK CURRENT VS. DUTY CYCLE % (REFRESH RATE f=1 KHz)



Model No : CST-S30320/S30321T9

SMT REFLOW SOLDERING INSTRUCTIONS

IR Reflow Temperature / Time :

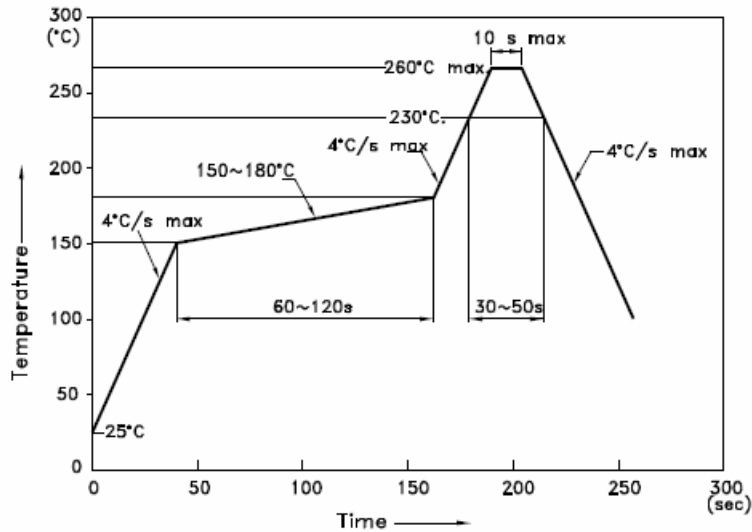

NOTES:

1. We recommend the reflow temperature 245°C(+/-5°C). The maximum soldering temperature should be limited to 260°C.
2. Don't cause stress to the epoxy resin while it is exposed to high temperature.
3. Number of reflow process shall be 2 times or less.

Soldering Pad Size

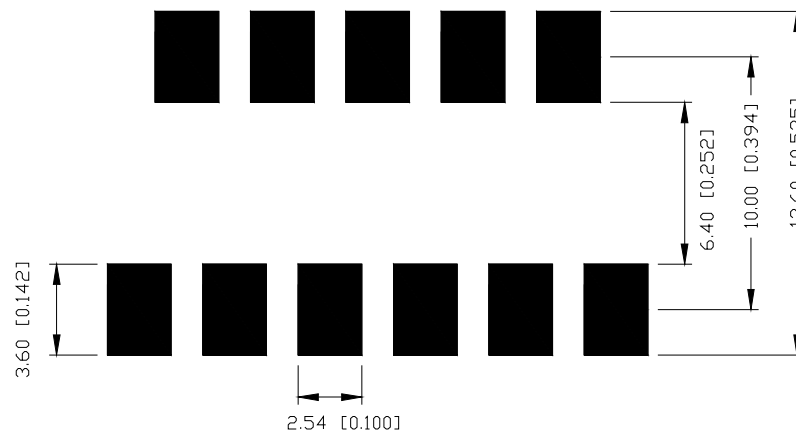



Model No : CST-S30320/S30321T9

REEL DIMENSIONS

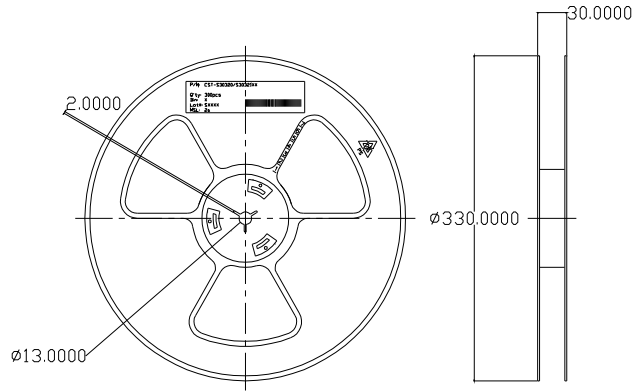

PACKING & LABEL SPECIFICATIONS

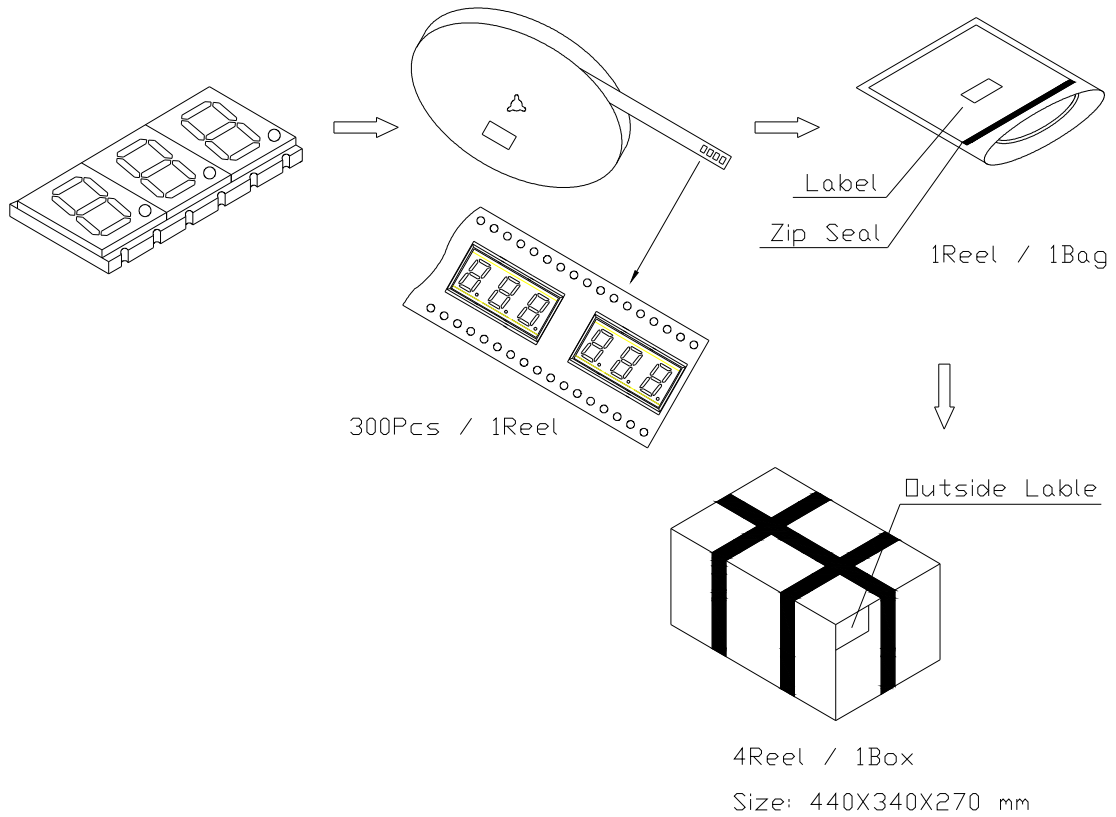

Note: The specifications are subject to change without notice. Please contact us for updated