

# SPECIFICATION FOR APPROVAL

REF : 20070414-A

PAGE: 1

PROD. NAME	SMD POWER INDUCTOR	ABC'S DWG NO.	SB1806□□□□L□-□□□
		ABC'S ITEM NO.	

**. CONFIGURATION & DIMENSIONS :**

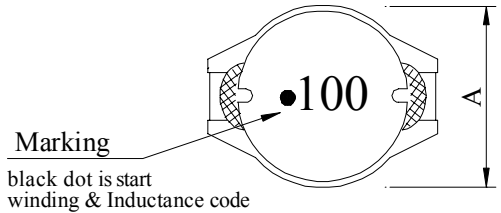

- A : 14.0±0.5 m/m
- B : 18.2±0.5 m/m
- C : 6.6±0.5 m/m
- D : 2.5±0.2 m/m
- E : 2.6±0.2 m/m
- F : 13.0±0.3 m/m
- G : 12.7 ref. m/m
- H : 2.9 ref. m/m
- I : 3.2 ref. m/m

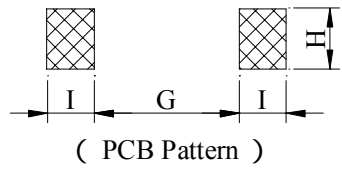
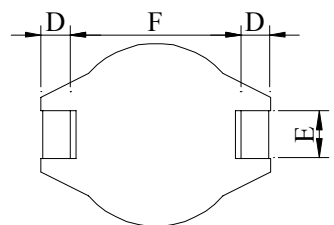
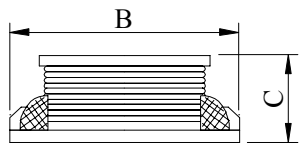

**. SCHEMATIC DIAGRAM :**

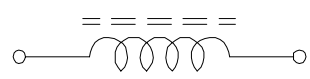

**. MATERIALS :**

- a . Core : Ferrite DR core
- b . Wire : Enamelled copper wire ( class F )
- c . Base : LCP E4008
- d . Terminal : Cu/Ni/Sn
- e . Adhesive : Epoxy resin
- f . Solder wire : Sn97/Cu3 Alloys
- g . Remark : Products comply with RoHS' requirements

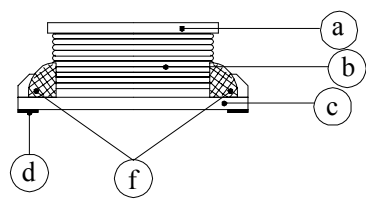

Peak Temp : 260 max.  
 Max time above 230 : 50sec max.  
 Max time above 200 : 70sec max.

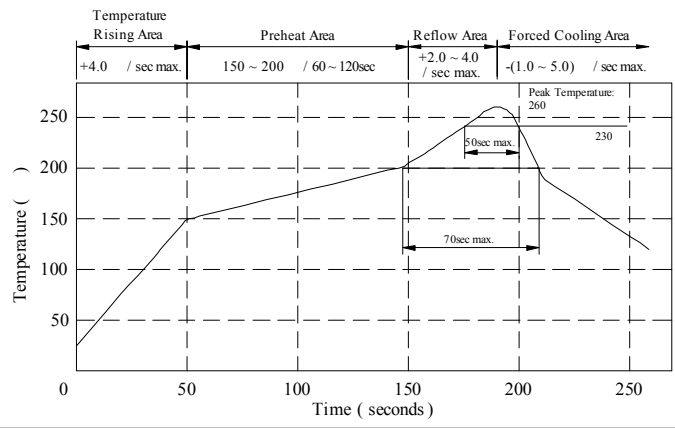

**. GENERAL SPECIFICATION :**

- a . Temp. rise : 40 max.
- b . Storage temp. : -40 ~ +125
- c . Operating temp. : -40 ~ +105
- d . Resistance to solder heat : 260 . 10 secs.

AR-001A

# SPECIFICATION FOR APPROVAL

REF : 20070414-A

PAGE: 2

PROD. NAME	SMD POWER INDUCTOR	ABC'S DWG NO.	SB1806□□□□L□-□□□
		ABC'S ITEM NO.	

**. ELECTRICAL CHARACTERISITCS :**

DWG No.	Inductance ( $\mu$ H)	SRF (MHz) typ.	RDC (m $\Omega$ ) max.	I <sub>rms</sub> (A)	I <sub>sat</sub> (A)
SB18061R0ML□-□□□	1.0 $\pm$ 20%	100.0	4.0	10.00	30.00
SB18062R2ML□-□□□	2.2 $\pm$ 20%	55.0	6.8	9.00	22.00
SB18063R3ML□-□□□	3.3 $\pm$ 20%	40.0	9.8	7.60	17.00
SB18065R6ML□-□□□	5.6 $\pm$ 20%	30.0	15.0	6.40	12.80
SB1806100ML□-□□□	10.0 $\pm$ 20%	25.0	25.0	5.30	10.00
SB1806150ML□-□□□	15.0 $\pm$ 20%	17.0	35.0	4.30	8.00
SB1806220ML□-□□□	22.0 $\pm$ 20%	13.0	45.0	3.60	6.70
SB1806330ML□-□□□	33.0 $\pm$ 20%	11.0	68.0	3.00	5.40
SB1806470ML□-□□□	47.0 $\pm$ 20%	9.0	95.0	2.50	4.60
SB1806680ML□-□□□	68.0 $\pm$ 20%	8.0	130.0	2.10	3.80
SB1806101KL□-□□□	100.0 $\pm$ 10%	7.0	190.0	1.70	3.20
SB1806151KL□-□□□	150.0 $\pm$ 10%	5.0	270.0	1.40	2.60
SB1806221KL□-□□□	220.0 $\pm$ 10%	4.5	420.0	1.10	2.20
SB1806331KL□-□□□	330.0 $\pm$ 10%	3.5	580.0	1.00	1.80
SB1806471KL□-□□□	470.0 $\pm$ 10%	3.0	820.0	0.80	1.50
SB1806681KL□-□□□	680.0 $\pm$ 10%	2.5	1200.0	0.70	1.20
SB1806102KL□-□□□	1000.0 $\pm$ 10%	2.0	1800.0	0.50	1.00

- 1). □ : Packaging information ... [A]: Bulk [B]: Taping Reel
- 2). "-□□□": Reference code
- 3). Inductance Test Freq. at 100KHz / 0.1V.
- 4). I<sub>rms</sub> base on T = 40 max.
- 5). I<sub>sat</sub> base on L/L0A = 10% typ.

@ Inductance VS. DC Current Curve

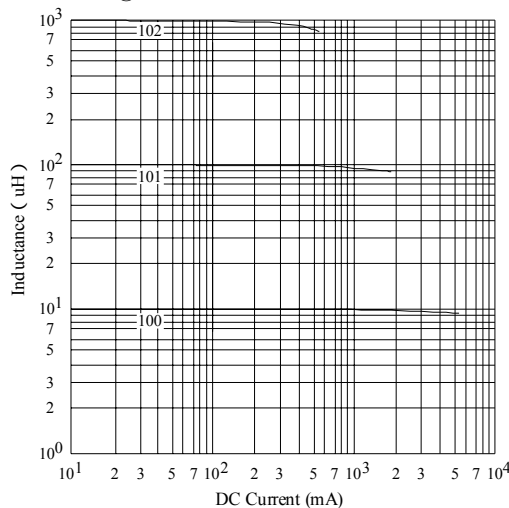

@ DC Current VS. Temp. Rise Curve

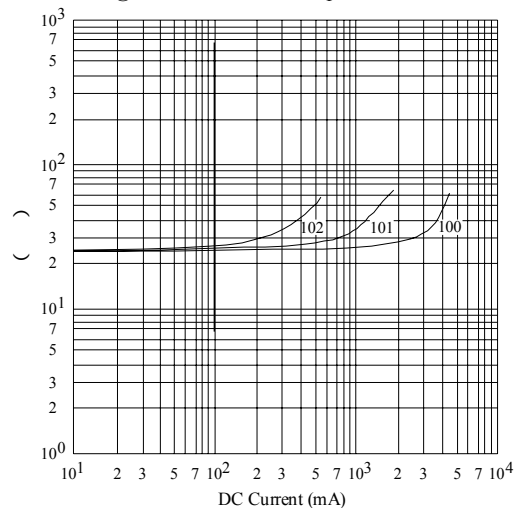

AR-001A

# SPECIFICATION FOR APPROVAL

REF : 20070414-A

PAGE: 3

PROD. NAME	SMD POWER INDUCTOR	ABC'S DWG NO.	SB1806□□□□L□-□□□
		ABC'S ITEM NO.	

**. PACKAGING INFORMATION :**

1. Configuration :

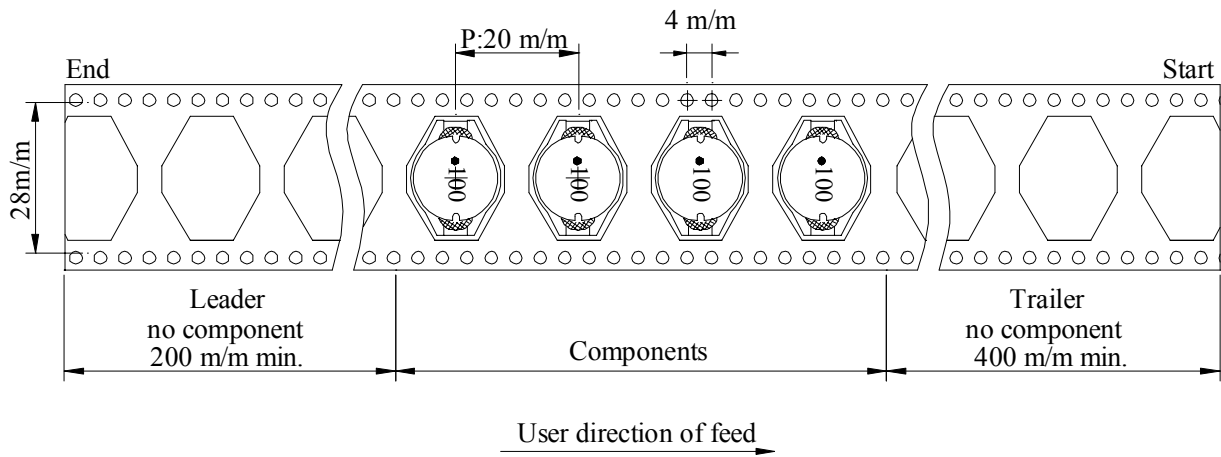
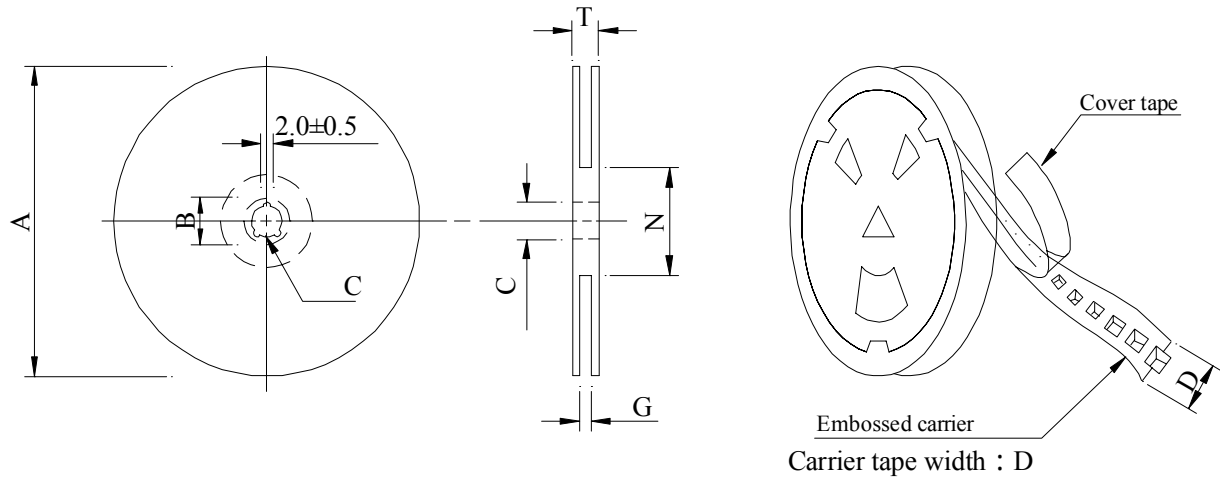

2. Dimensions : (m/m)

Style	A	B	C	D	G	N	T
13 - 32	330	21±0.8	13±0.5	32	34 <sup>+0</sup>	100 <sup>-0</sup>	38.4

3. Q'TY & G.W. Per package :

Series	Inner : Reel			Outer : Carton		
	Q'TY (pcs)	G.W. (gw)	Style	Q'TY (pcs)	G.W. (kg)	Size (cm)
SB1806	250	1,250	13 - 32	1,000	6.8	40 x 40 x 24

# SPECIFICATION FOR APPROVAL

REF : 20070414-A

PAGE: 4

PROD. NAME	SMD POWER INDUCTOR	ABC'S DWG NO.	SB1806□□□□L□-□□□
		ABC'S ITEM NO.	

. DWGING NUMBER EXPRESSION :

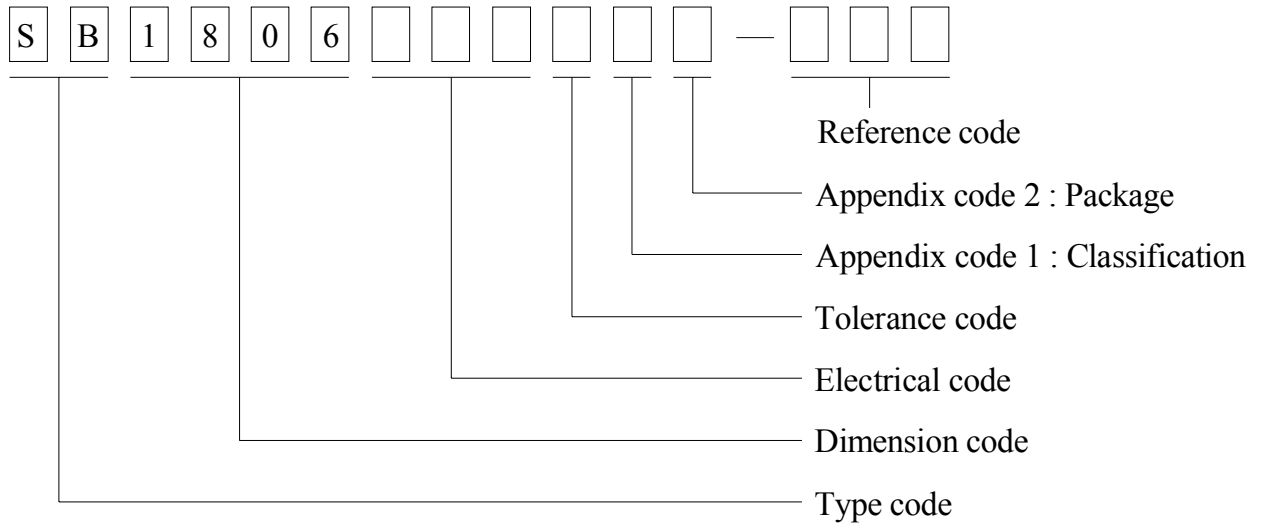

Appendix code 1 : Product Classification

- L : Lead Free Standard products comply with RoHS' requirements
- 1 ~ 9 : Lead Free Special products comply with RoHS' requirements

Appendix code 2 : Package Information

Code	Inner package	Inner Package Q'TY	Remark
A	T.B.D.	T.B.D.	
B	T / R ( Reel package )	250 pcs	

# SPECIFICATION FOR APPROVAL

REF : 20070414-A

PAGE: 5

PROD. NAME	SMD POWER INDUCTOR	ABC'S DWG NO.	SB1806□□□□L□-□□□
		ABC'S ITEM NO.	

**. RELIABILITY TEST :**

Test item	Specification	Test condition						
Solderability	More than 90% of the terminal electrode shall be covered with fresh solder.	Preheat : 150±25 for 60 seconds Solder : Sn96.5 / Ag3 / Cu0.5 or equivalent Solder temp. : 235±5 Flux : Rosin Dip time : 4±1 seconds						
Thermal shock test ( Temp. cycle )	Inductance shall not change more than ±20%	<table style="width: 100%; border: none;"> <tr> <td style="text-align: center;">Room temp. 15 minutes</td> <td style="text-align: center;">→</td> <td style="text-align: center;">-25±2 30 minutes</td> </tr> <tr> <td style="text-align: center;">Room temp. 15 minutes</td> <td style="text-align: center;">→</td> <td style="text-align: center;">85±2 30 minutes</td> </tr> </table> <p>Total : 50 cycles</p>	Room temp. 15 minutes	→	-25±2 30 minutes	Room temp. 15 minutes	→	85±2 30 minutes
Room temp. 15 minutes		→	-25±2 30 minutes					
Room temp. 15 minutes		→	85±2 30 minutes					
Humidity Resistance test		Temperature : 40±2 Humidity : 90 ~ 95% Applied current : Per spec. Time : 500 hours						
High temp. Resistance test	Temperature : 105±2 Applied current : Per spec. Time : 500 hours							

# SPECIFICATION FOR APPROVAL

REF : 20070414-A

PAGE: 6

PROD. NAME	SMD POWER INDUCTOR	ABC'S DWG NO.	SB1806□□□□L□-□□□
		ABC'S ITEM NO.	

UL CARD :

OBMW2 September 8, 2000  
Magnet Wire-Component  
JUNG SHING WIRE CO LTD E174837  
231 CHUNG CHENG RD, SEC 3 JEN-TEH HSIANG, TAINAN  
HSIEN TAIWAN

Mtl Dsg	Mark Dsg	BC	Coat Typ	OC	ANSI Type	Temp Class
AIW	---	Polyamideimide	---	---	MW81-C	220
CFUEWB	---	Polyurethane	---	---	MW75C	130
EIAIW	---	Polyesterimide	Polyamideimide	---	MW35C	200
EILOCKY	---	Polyesterimide	Polyamide	---	---	180
EILOCKW	---	Polyesterimide	Modified Epoxy	---	---	200
EIW	---	Polyesterimide	---	---	---	220
EIW-2	---	Polyesterimide	---	---	MW74-C	200
FL.EILOCKY	---	Modified Polyester	Polyamide	---	---	155
LSFFW	---	Polyurethane	---	---	MW79-C	155
LSUEW	---	Polyurethane	---	---	---	130
PEW	---	Polyester	---	---	---	155
PEY	---	Polyester	Nylon	---	MW24-C	155
SF.FLW	---	Modified Polyester	---	---	MW26C	155
SF.EIW	---	Polyesterimide	---	---	MW77C	180
SF.BY@	---	Modified Polyester	Nylon	---	MW27-C	155
SF.FLY@	---	Modified Polyester	Nylon	---	MW27-C	155
SF.BLOCKBS	---	Modified Polyester	Modified Polyamide	---	---	155
SF.EILOCKY#	---	Polyesterimide	Polyamide	---	---	180
SF.EILOCKBS	---	Polyesterimide	Modified Polyamide	---	---	180
SF.BW@	---	Modified Polyester	Polyamide	---	MW26C	155
SFFW	---	Polyurethane	---	---	MW79	155

A not-for-profit organization dedicated to public safety and committed to quality service

287806002 Page 1 of 2

Mtl Dsg	Mark Dsg	BC	Coat Typ	OC	ANSI Type	Temp Class
SFFY	---	Polyurethane	Polyamide	---	MW80C	155
UEW-1	---	Polyurethane	---	---	MW2-C	105
UEW-2	---	Polyurethane	---	---	---	130
UEW-4	---	Polyurethane	---	---	MW75C	130
UEY	---	Polyurethane	Nylon	---	MW28-C	130
UEY-2	---	Polyurethane	Polyamide	---	MW28-C	130

@-May be suffixed by LZ; # - May be suffixed by LZ, EL or LZI.  
LZ - Signifies magned wires twisted together; EL - signifies base coated magnet wire laid parallel with top coat applied overall; LZL - signifies base coated magnet wire twisted together and covered with top coat overall.  
Marking: Company name or trademarks **JSW** or 榮星電線, material designation or marked designation on packaed or reel, and Recognized Component Mark.

See General Information Preceding These Recognitions  
For use only in equipment where the acceptability of the combination is determined by Underwriters Laboratories Inc.

287806002 Page 2 of 2 OBMW2/E174837  
September 8, 2000

# SPECIFICATION FOR APPROVAL

REF : 20070414-A

PAGE: 7

PROD. NAME	SMD POWER INDUCTOR	ABC'S DWG NO. ABC'S ITEM NO.	SB1806□□□□L□-□□□
---------------	--------------------	---------------------------------	------------------

		SUMITOMO CHEMICAL CO LTD 5-33 KITAHAMA 4-CHOME CHUO-KO, OSAKA JAPAN						E54705 (M)			
Mtl Dsg	Col	Min Thk mm	UL94 Flame Class	Elec	RTI Mech with Imp	w/o Imp	H W I	H A I	H V T R	D 4 9 5	C T I
Liquid crystal polyester (LCP), designated "EKONOL" or "SUMIKASUPER", furnished in the form of pellets, (Contd)											
E4008, E400X	NC, BK	0.30	94V-0	130	130	130	—	—	—	—	—
		0.75	94V-0	130	130	130	3	4	—	—	—
		1.5	94V-0	130	130	130	2	4	—	—	—
		3.0	94V-0	130	130	130	1	4	0	5	4
E4008	NC, WT, BK	0.30	94V-0	130	130	130	—	—	—	—	—
		0.75	94V-0	220	180	220	3	4	—	—	—
		1.5	94V-0	220	200	240	2	4	—	—	—
		3.0	94V-0	220	200	240	1	4	0	5	4
E4010	NC, BK	0.30	94V-0	130	130	130	—	—	—	—	—
		0.75	94V-0	220	180	220	3	4	—	—	—
		1.5	94V-0	220	200	240	2	4	—	—	—
		3.0	94V-0	220	200	240	1	4	0	5	4
E400(Y)L, E4008L	NC, BK	0.30	94V-0	130	130	130	—	—	—	—	—
		0.75	94V-0	130	130	130	3	4	—	—	—
		1.5	94V-0	130	130	130	2	4	—	—	—
		3.0	94V-0	130	130	130	1	4	0	5	4
E4810	NC, BK	0.30	94V-0	130	130	130	—	—	—	—	—
		0.75	94V-0	130	130	130	0	4	—	—	—
		1.5	94V-0	130	130	130	0	4	—	—	—
		3.0	94V-0	130	130	130	1	4	0	5	4

(X) Denotes any number 1 thru 9.  
(Y) Denotes any number 1 thru 7.