



PM053-115-1225BT-4 PM053-230-1225BT-4

Features

Size: 120 x 120 x 25 mm (4.7" x 4.7" x 1.0")
 Airflow: 53 CFM
 Weight: 338 grams (12 oz)
 Noise: 38 dBA
 Terminal: .120 inches
 Impeller: Reinforced Plastic (94V-0)
 Frame: Aluminum Alloy
 Bearings: Sealed Ball



UL E101153



CUL E101153

• RoHS Compliant

Dimensions – inches mm

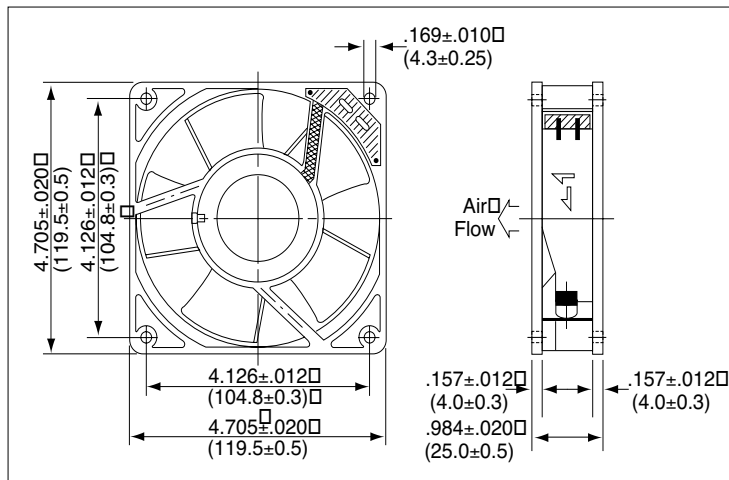

Air Flow vs Air Pressure

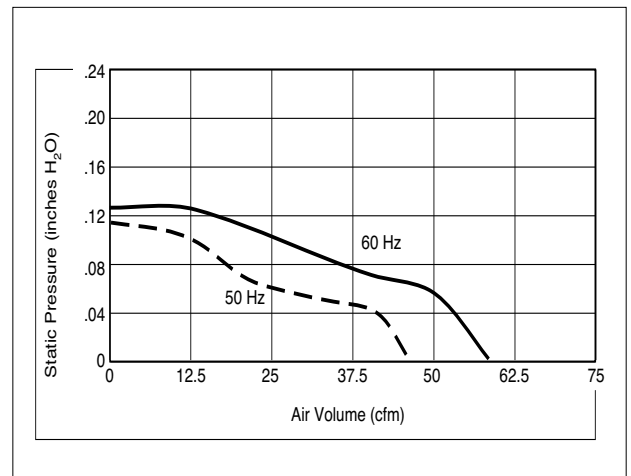

Performance

Type	Rated Voltage (V)	Operating Frequency (Hz)	Input Power (W) (@ 60 Hz)	Max Air Flow (CFM)	Max Air Pressure (In H ₂ O)	Noise* (dBA)	Operating Temperature (°C)	Life Expectancy (Hr) (@ 20 ±15°C)
PM053-115-1225BT-4	115	50/60	13.0	53	0.12	38	-20~ +85	60,000
PM053-230-1225BT-4	230	50/60	13.0	53	0.12	38	-20~ +85	60,000

*Measured 1 m from intake

Product specifications contained herein may be changed without prior notice.

It is therefore advisable to contact Purdy Electronics before proceeding with the design of equipment incorporating this product.