

1. PART NO. EXPRESSION :

P D B 1 0 0 5 1 0 1 M Z F

(a) (b) (c) (d)(e)(f)

- (a) Series code
- (b) Dimension code
- (c) Inductance code : 101 = 100uH
- (d) Tolerance code : M = ±20%
- (e) X, Y, Z : Standard part
- (f) F : Lead Free

2. CONFIGURATION & DIMENSIONS :

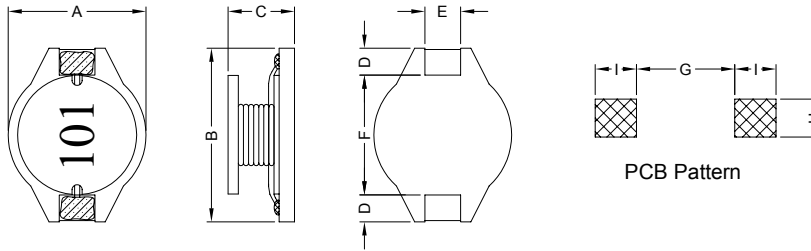

Unit:m/m

A	B	C	D	E	F	G	H	I
10.0±0.2	12.7±0.2	5.0±0.3	2.4±0.2	2.2±0.2	7.6±0.3	7.3 Ref.	2.8 Ref.	3.0 Ref.

3. SCHEMATIC :

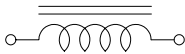

4. MATERIALS :

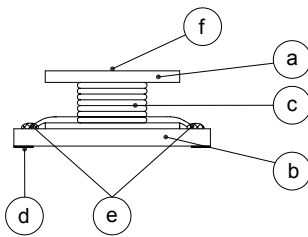

- (a) Core : DR Ferrite Core
- (b) Base : LCP
- (c) Wire : Enamelled Copper Wire
- (d) Terminal : Tinned Copper Plate
- (e) Adhesive : Epoxy
- (f) Ink : Bon Margue

5. GENERAL SPECIFICATION :

- a) Temp. rise : 40°C Max.
- b) Rated current : Base on temp. rise & $\Delta L/L0A = 10\%$ Typ.
- c) Storage temp. : -40°C to +125°C
- d) Operating temp. : -40°C to +85°C
- e) Resistance to solder heat : 260°C.10 secs



RoHS Compliant

NOTE : Specifications subject to change without notice. Please check our website for latest information.

01.05.2008



SUPERWORLD ELECTRONICS (S) PTE LTD

6. ELECTRICAL CHARACTERISTICS :

Part No.	Inductance (μ H)	Q Ref.	Test Frequency (Hz)	SRF (MHz) Typ.	RDC (m Ω) Max.	IDC (A)
PDB10051R0MZF	1.0 \pm 20%	50	1V / 100K	150.0	9	6.8
PDB10051R5MZF	1.5 \pm 20%	50	1V / 100K	100.0	10	6.4
PDB10052R2MZF	2.2 \pm 20%	45	1V / 100K	85.0	12	6.1
PDB10053R3MZF	3.3 \pm 20%	35	1V / 100K	60.0	15	5.4
PDB10054R7MZF	4.7 \pm 20%	35	1V / 100K	45.0	18	4.8
PDB10056R8MZF	6.8 \pm 20%	35	1V / 100K	35.0	27	4.4
PDB1005100MZF	10.0 \pm 20%	30	1V / 100K	25.0	38	3.9
PDB1005150MZF	15.0 \pm 20%	30	1V / 100K	20.0	46	3.1
PDB1005220MZF	22.0 \pm 20%	25	1V / 100K	18.0	85	2.7
PDB1005330MZF	33.0 \pm 20%	30	1V / 100K	14.0	100	2.1
PDB1005470MZF	47.0 \pm 20%	20	1V / 100K	11.0	140	1.8
PDB1005680MZF	68.0 \pm 20%	35	1V / 100K	10.0	200	1.5
PDB1005101MZF	100.0 \pm 20%	40	1V / 100K	7.0	280	1.3
PDB1005151MZF	150.0 \pm 20%	40	1V / 100K	6.5	400	1.0
PDB1005221MZF	220.0 \pm 20%	40	1V / 100K	5.0	610	0.8
PDB1005331MZF	330.0 \pm 20%	60	1V / 100K	4.0	1020	0.6
PDB1005471MZF	470.0 \pm 20%	50	1V / 100K	3.0	1270	0.5
PDB1005681MZF	680.0 \pm 20%	65	1V / 100K	2.5	2020	0.4
PDB1005102MZF	1000.0 \pm 20%	60	1V / 100K	2.0	3000	0.3



RoHS Compliant

NOTE : Specifications subject to change without notice. Please check our website for latest information.

01.05.2008



SUPERWORLD ELECTRONICS (S) PTE LTD

PG. 2

7. CHARACTERISTICS CURVES :

@ TEMP. RISE VS. DC SUPERPOSITION RESPONSE CURVE

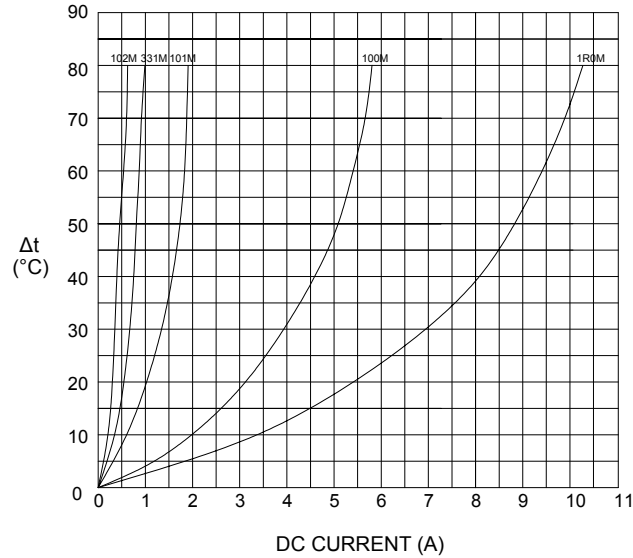

@ INDUCTANCE VS. FREQUENCY RESPONSE CURVE

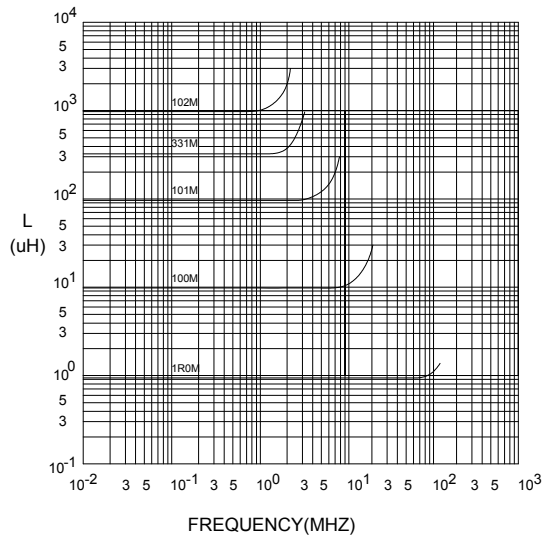

@ INDUCTANCE VS. DC SUPERPOSITION RESPONSE CURVE

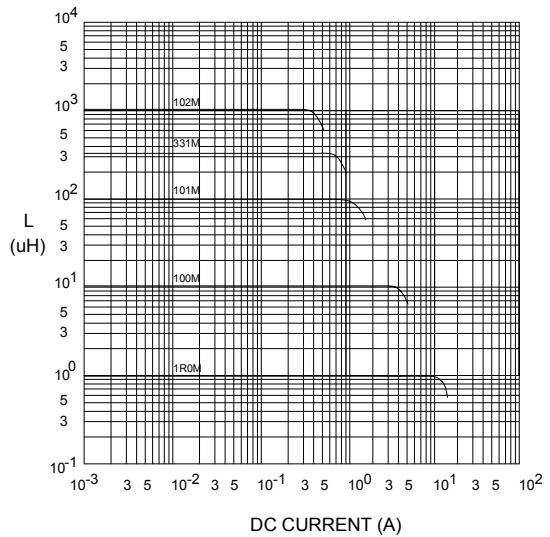

NOTE : Specifications subject to change without notice. Please check our website for latest information.



RoHS Compliant

01.05.2008



SUPERWORLD ELECTRONICS (S) PTE LTD

RECOMMENDED SOLDERING CONDITIONS REFLOW SOLDERINGS

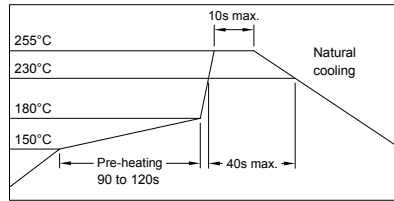

8. PACKAGING INFORMATION :

(1) CONFIGURATION

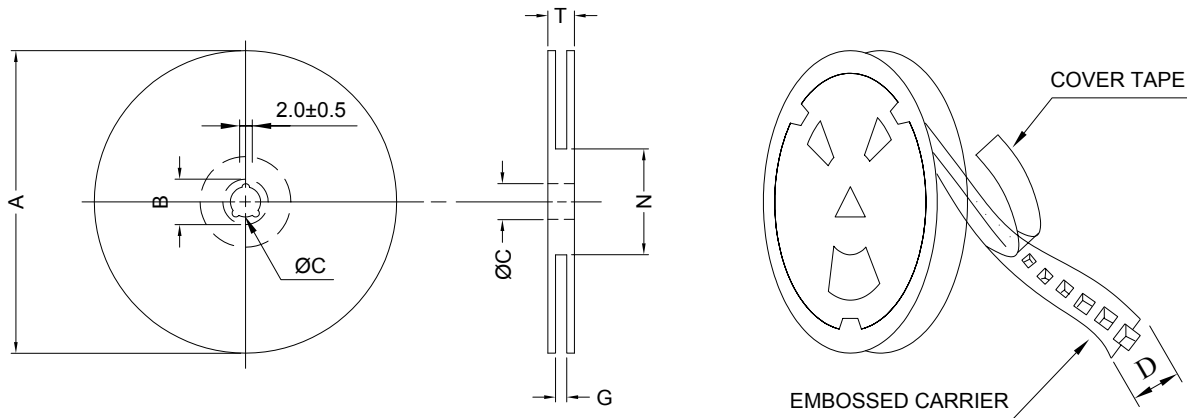

* CARRIER TAPE WIDTH : D

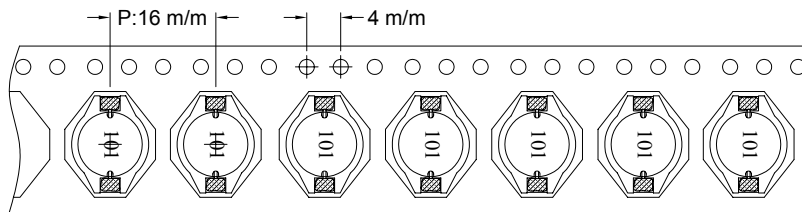

(2) DIMENSIONS

Unit:m/m

STYLE	A	B	C	D	G	N	T
13-24	330	21±0.8	13±0.5	24	26 ⁺⁰	50 ⁻⁰	30.4

(3) Q'TY & G.W. PER PACKAGE

SERIES	INNER : REEL			OUTER : CARTON		
	Q'TY (PCS)	G.W. (gw)	STYLE	Q'TY (PCS)	G.W. (Kg)	SIZE (cm)
PDB1005	600	1100	13-24	2400	7.90	40 x 40 x 24



RoHS Compliant

NOTE : Specifications subject to change without notice. Please check our website for latest information.

01.05.2008



SUPERWORLD ELECTRONICS (S) PTE LTD

9. RELIABILITY AND TEST CONDITION :

TEST ITEM	SPECIFICATION	TEST CONDITION
SOLDERABILITY	MORE THAN 90% OF THE TERMINAL ELECTRODE SHALL BE COVERED WITH FRESH SOLDER.	PREHEAT : 125±25°C FOR 60 SECONDS SOLDER : 99%Sn/0.3%Ag/0.7%Cu OR EQUIVALENT SOLDER TEMP. : 245±5°C FLUX : ROSIN DIP TIME : 4±1 SECONDS
THERMAL SHOCK TEST (TEMP. CYCLE)	INDUCTANCE SHALL NOT CHANGE MORE THAN ±20%	ROOM TEMP. → -25±2°C 15 MINUTES → 30 MINUTES ROOM TEMP. → 85±2°C 15 MINUTES → 30 MINUTES TOTAL : 50 CYCLES
HUMIDITY RESISTANCE TEST		TEMPERATURE : 40±2°C HUMIDITY : 90 ~ 95% APPLIED CURRENT : PER SPEC. TIME : 500 HOURS
HIGH TEMP. RESISTANCE TEST		TEMPERATURE : 85±2°C APPLIED CURRENT : PER SPEC. TIME : 500 HOURS



RoHS Compliant

NOTE : Specifications subject to change without notice. Please check our website for latest information.

01.05.2008



SUPERWORLD ELECTRONICS (S) PTE LTD

10. UL CARD :

OBMW2 **November 30, 2000**
Magnet Wire - Component

PACIFIC ELECTRIC WIRE & CABLE (SHENZHEN) CO LTD **E201757**
 607 BAOLONG INDUSTRIAL ESTATE LONGGANG, SHENZHEN
 GUANGDONG CHINA

Mtl Dsg	BC	Coating Type	TC	ANSI Type	TI
UEW/U		Polyurethane	—	—	130
PEW/U		Polyester	—	MW5-C	155°C
PEWH/U		Modified Polyester	—	MW30-C	180
PEW-NY/U		Polyester	Polyamide	MW24-C	155
HAI/U		Polyester(Amide)(Imide)	Polyamideimide	MW35,73	200
UEW-NY/U		Polyurethane	Polyamide	MW80-C	155
				MW28-C	130

Marking: Company name and material designation or marked designation on package or reel, and Recognized Component Mark.

See General Information Preceding These Recognitions

1/3/2001 **Underwriters Laboratories Inc.** **Card 1 of 2**

SUMITOMO CHEMICAL CO LTD **E54705 (M)**
 5-33 KITAHAMA 4-CHOME CHUO-KO, OSAKA JAPAN

Mtl Dsg	Col	Min Thk mm	UL94 Flame Class	Elec	RTI with Imp	Mech w/o Imp	H W I	H A I	H V R	D 4 5	C T I
Liquid crystal polyester (LCP), designated "EKONOL" or "SUMIKASUPER", furnished in the form of pellets, (Contd)											
E4008 , E400X	NC , BK	0.30	94V-0	130	130	130	—	—	—	—	—
		0.75	94V-0	130	130	130	3	4	—	—	—
		1.5	94V-0	130	130	130	2	4	—	—	—
E4008	NC , WT , BK	3.0	94V-0	130	130	130	1	4	0	5	4
		0.30	94V-0	130	130	130	—	—	—	—	—
		0.75	94V-0	220	180	220	3	4	—	—	—
E4010	NC , BK	1.5	94V-0	220	200	240	2	4	—	—	—
		3.0	94V-0	220	200	240	1	4	0	5	4
		0.30	94V-0	130	130	130	—	—	—	—	—
E400(Y)L , E4008L	NC , BK	0.75	94V-0	220	180	220	3	4	—	—	—
		1.5	94V-0	220	200	240	2	4	—	—	—
		3.0	94V-0	220	200	240	1	4	0	5	4
E4810	NC , BK	0.30	94V-0	130	130	130	—	—	—	—	—
		0.75	94V-0	130	130	130	3	4	—	—	—
		1.5	94V-0	130	130	130	2	4	—	—	—
		3.0	94V-0	130	130	130	1	4	0	5	4
		0.30	94V-0	130	130	130	—	—	—	—	—
		0.75	94V-0	130	130	130	0	4	—	—	—
		1.5	94V-0	130	130	130	0	4	—	—	—
		3.0	94V-0	130	130	130	1	4	0	5	4

(X) Denotes any number 1 thru 9.
(Y) Denotes any number 1 thru 7.



RoHS Compliant

NOTE : Specifications subject to change without notice. Please check our website for latest information.

01.05.2008



SUPERWORLD ELECTRONICS (S) PTE LTD