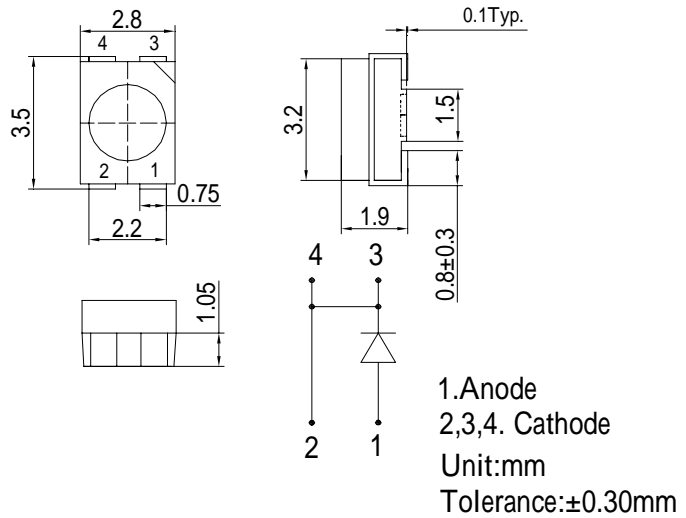

■Features

- High Luminous PLCC4 Power Top SMD LEDs
- 3.5x2.8x1.9mm Standard Directivity
- Long Lifetime Operation (Up to 100,000hours)
- Superior Weather-resistance
- UV Resistant Epoxy

■Applications

- Automotive Dashboard Lighting
- Traffic Signal Lamp
- Back Lighting
- Other Lighting

■Outline Dimension

■Absolute Maximum Rating

(Ta=25)

Item	Symbol	Value	Unit
DC Forward Current	I_F	35	mA
Pulse Forward Current*	I_{FP}	100	mA
Reverse Voltage	V_R	5	V
Power Dissipation	P_D	133	mW
Operating Temperature	T_{opr}	-30 ~ +85	
Storage Temperature	T_{stg}	-40~ +100	
Lead Soldering Temperature	T_{sol}	260 /5sec	-

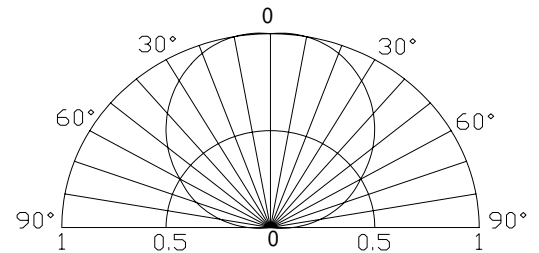
*Pulse width Max.10ms , Duty ratio max 1/10

■Directivity

Electrical -Optical Characteristics

(Ta=25)

Item	Symbol	Condition	Min.	Typ.	Max.	Unit
DC Forward Voltage	V_F	$I_F=30mA$	3.0	3.3	3.8	V
DC Reverse Current	I_R	$V_R=5V$	-	-	10	μA
Luminous Intensity*	I_v	$I_F=30mA$	-	1900	-	mcd
Chromaticity Coordinates*	x	$I_F=30mA$	-	0.45	-	
	y	$I_F=30mA$	-	0.41	-	
50% Power Angle	$2\theta_{1/2}$	$I_F=30mA$	-	120	-	deg

*1 Tolerance of chromaticity coordinates is ±10%

*2 Tolerance of luminous intensity is ±15%