

# Guardamotores MS

Con protección contra sobrecarga y cortocircuito,  
sensibilidad al fallo de fase de acuerdo a IEC 947-4-1, DIN VDE 0660 Part 102

Debido a su alta capacidad de ruptura con alta limitación de corriente, los guardamotores MS suministran una óptima protección para motores eléctricos, así como a otras aplicaciones hasta 25 amperes. Están equipados con un dispositivo de sensibilidad al fallo de fase, aislamiento y principalmente funciones de switch, 13 rangos de corriente nominal cubren de 0.1 hasta 25 amperes.

Se puede obtener hasta 100kA, de ruptura si se usan con Limitadores de corriente cat. SBMS32. Los guardamotores MS son automáticamente compensados contra las variaciones de la temperatura ambiente; el funcionamiento del disparador de corriente en cortocircuito es 12 x I<sub>n</sub>. Los guardamotores MS están de conformidad con IEC 947.

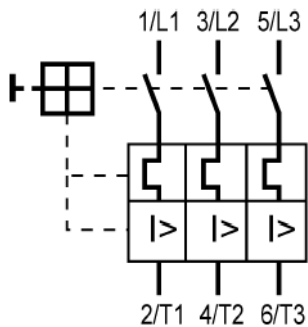

Max. Poder de operación (kW/CA-3)				Ajuste de los disparadores térmicos (A)	Ajuste instantáneo (A)	Código	Peso g/pza.	Pzas X Emp.
220V KW	220V HP	440V KW	440V HP					
—	—	—	—	0.1 - 0.16	1.92	<b>MS016</b>	250	1
0.04	0.06	—	—	0.16 - 0.25	3	<b>MS025</b>	250	1
0.06	0.12	—	—	0.25 - 0.4	4.8	<b>MS04</b>	250	1
0.08	0.18	—	—	0.4 - 0.63	7.6	<b>MS063</b>	250	1
0.18	0.25	—	1/2	0.63 - 1	12	<b>MS1</b>	250	1
0.35	0.55	—	3/4	1 - 1.6	19.2	<b>MS1.6</b>	250	1
0.5	1.1	1/2	1	1.6 - 2.5	30	<b>MS2.5</b>	250	1
1	1.5	3/4	2	2.5 - 4	48	<b>MS4</b>	250	1
1.3	3	1 1/2	3	4 - 6.3	75.6	<b>MS6.3</b>	250	1
2.5	4	2	5	6.3 - 10	120	<b>MS10</b>	250	1
4	9	3	10	10 - 16	192	<b>MS16</b>	250	1
5	1	5	15	16 - 20	240	<b>MS20</b>	250	1
7	12.5	5	15	20 - 25	300	<b>MS25</b>	250	1

## Guardamotores para motores monofásicos

Con protección contra sobrecarga y cortocircuito de acuerdo a IEC 947-4-1, DIN VDE 0660 Parte 102 con ó sin contacto auxiliar integrado.

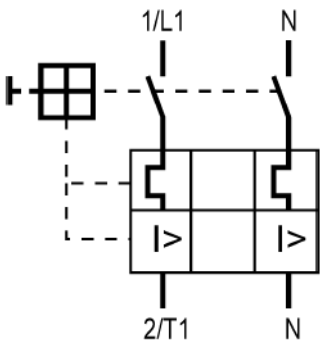

Max. Poder de operación (kW/CA-3)				Ajuste de los disparadores térmicos (A)	Ajuste instantáneo (A)	Artículo sin contacto auxiliar	Artículo con contacto auxiliar
127V KW	127V HP	220V KW	220V HP			Código	Código
—	—	0.08	—	0.63 - 1	12	<b>MSW1</b>	<b>MSH1</b>
—	—	0.1	—	1 - 1.6	19.2	<b>MSW1.6</b>	<b>MSH1.6</b>
0.1	—	0.16	1/6	1.6 - 2.5	30	<b>MSW2.5</b>	<b>MSH2.5</b>
0.14	—	0.33	1/4	2.5 - 4	48	<b>MSW4</b>	<b>MSH4</b>
0.27	1/2-1/4	0.5	1/3-1/2	4 - 6.3	75.6	<b>MSW6.3</b>	<b>MSH6.3</b>
0.56	1/3-1/2	1.5	3/4-1	6.3 - 10	120	<b>MSW10</b>	<b>MSH10</b>
1.1	3/4-1	2	1 1/2-2	10 - 16	192	<b>MSW16</b>	<b>MSH16</b>
1.65	1 1/2	3	3	16 - 20	240	<b>MSW20</b>	<b>MSH20</b>

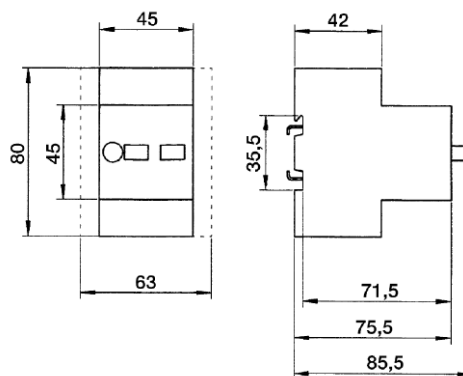

Nota: Todas las dimensiones se muestran en milímetros, para convertir a pulgadas, dividir entre 25.4

## Bloques de contactos auxiliares montaje lateral



Ancho mm	Diagrama de cableado	Contactos	Código	Peso g/pza	Emp. Std.
9		2NO	HMS20	40	10
9		1NO + 1NC	HMS11	40	10
9		1NO	HMS10	35	10
9		2NC	HMS02	40	10
9		1NC	HMS01	35	10



### Gabinete Sobreponer IP 55

Terminal T/N integrada con 2 knock-outs arriba y 2 abajo métricos

Código	Peso g/pza.	Paq. Std.
MS.G55	240	1

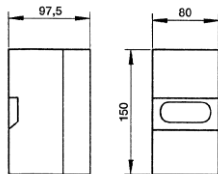

### Botón Hongo paro de emergencia

Girar o con llave para desenclavar, color rojo o amarillo

Desenclavamiento Tipo	Código	Peso g/pza.	Paq. Std.
Girar	MS.PV	60	5
Con Llave	MS.PS2	65	5

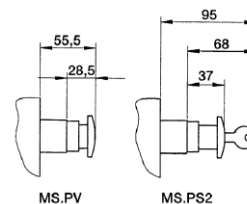

### Gabinete montaje empotrado IP55

Terminal T/N integrada

Código	Peso g/pza.	Paq. Std.
MS.F55	170	1

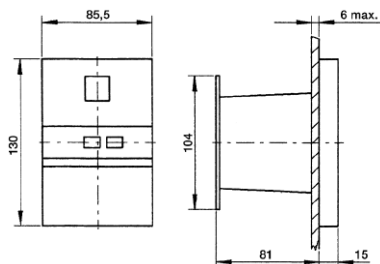

### Lámpara Indicadora

con foco de neón, rango de voltaje: 220 - 240V or 380 - 440V

Color	Código	Peso g/pza.	Paq. Std.
	220-240V	380-440V	
trans.	MS.SLW2	MS.SLW3	10 5
verde	MS.SLG2	MS.SLG3	10 5
rojo	MS.SLR2	MS.SLR3	10 5
amarillo	MS.SLJ2	MS.SLJ3	10 5



## Busbar



Busbar 63A	para 2 MS	para 3 MS	para 4 MS	para 5 MS
	Código	Código	Código	Código
Sin contacto aux.	G45-14-2	G45-14-3	G45-14-4	G45-14-5
Con contacto aux.	G54-14-2	G54-14-3	G54-14-4	G54-14-5

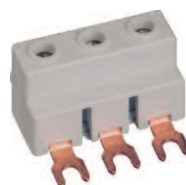

### Bloque alimentador de potencia

Código	Clasificación (A)	Paq. Std.
GE2-14	63A	1

Nota: Todas las dimensiones se muestran en milímetros, para convertir a pulgadas, dividir entre 25.4

# Interrupidores Miniatura

## CURVA -B CARACTERISTICAS

### Ejem. De Aplicación:

Equipo de oficina, protección de cableado, iluminación, aparatos electrodomesticos, circuitos de control, algunos motores y también para algunas aplicaciones electronicas. Con un relativamente largo disparo térmico y un bajo disparo magnético.

### Normas:

- IEC 60898
- EN 60898
- DIN VDE 0641
- IEC 60974-2
- EN 60974-2
- DIN VDE 0660

Nota: Para MCB's con  277Y/480V y clasificación 10kA por favor contacte con Altech.

### Certificación:



### Clasificación de Voltaje\*

### Capacidad interruptiva (IEC – Clasif.)

### Máximo fusible de respaldo De acuerdo a IEC60269

### Durabilidad Mecánica

### Temperatura de calibración

### Paq. Estandar y peso

### Tamaño de terminal aceptada

### Torque de terminal

### Dimensiones básicas (Vista frontal)

\* DC Clasificación (Certificación del fabricante): Un polo 60V CD, dos polos series 125V CD

## UN POLO



1B

## UN POLO MAS NEUTRO



8B

Clasif. Corriente	Código	Aprobación	Código	Aprobación
0.3A	ND		ND	
0.5A	ND		ND	
0.75A	ND		ND	
0.8A	ND		ND	
1.0A	ND		ND	
1.6A	ND		ND	
2.0A	ND		ND	
2.5A	ND		ND	
3.0A	ND		ND	
3.5A	ND		ND	
4.0A	ND		ND	
5.0A	ND		ND	
6.0A	1B6.06		8B6.06	
8.0A	ND		ND	
10A	1B106		8B106	
13A	1B136		8B136	
16A	1B166		8B166	
20A	1B206		8B206	
25A	1B256		8B256	
32A	1B326		8B326	
40A	1B406		8B406	
50A	1B506		8B506	
63A	1B636		8B636	
230V CA			230/400V CA	
6.0 - 63A (RC): 6kA			6.0 - 63A (RC): 6kA	
6.0 - 20A (RC) : 80A			6.0 - 20A (RC) : 80A	
25 - 32A (RC) : 100A			25 - 32A (RC) : 100A	
40 - 63A (RC) : 125A			40 - 63A (RC) : 125A	
20000 ON/OFF operaciones			20000 ON/OFF operaciones	
30°C (86°F)			30°C (86°F)	
10/0.3A - 32A = 1.4kg (3.1 lb.)			5/0.3A - 32A = 1.3kg (2.9 lb.)	
40A - 63A = 1.6kg (3.5 lb.)			40A - 63A = 1.45kg (3.2 lb.)	
Arriba: 18-3 AWG; 0.5-25mm <sup>2</sup>			Arriba: 18-3 AWG; 0.5-25mm <sup>2</sup>	
Abajo: 18-2 AWG; 0.5-35mm <sup>2</sup>			Abajo: 18-2 AWG; 0.5-35mm <sup>2</sup>	
22 lb.in.; max 2.5 Nm			22 lb.in.; max 2.5 Nm	

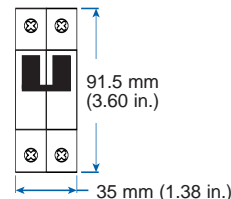
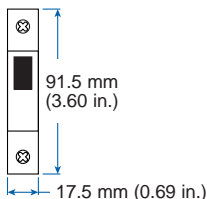

## DOS POLOS



**2B**



## TRES POLOS



**3B**



### Dimensiones Basicas (vista lateral)

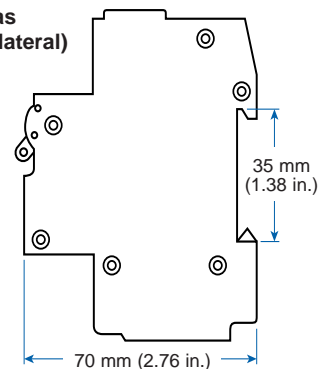

Clasif. Corriente

Código

Aprobación

Código

Aprobación

0.3A

ND

ND

0.5A

ND

ND

0.75A

ND

ND

0.8A

ND

ND

1.0A

ND

ND

1.6A

ND

ND

2.0A

ND

ND

2.5A

ND

ND

3.0A

ND

ND

3.5A

ND

ND

4.0A

ND

ND

5.0A

ND

ND

6.0A

2B6.06



3B6.06



8.0A

ND

ND

10A

2B106



3B106



13A

2B136



3B136



16A

2B166



3B166



20A

2B206



3B206



25A

2B256



3B256



32A

2B326



3B326



40A

2B406



3B406



50A

2B506



3B506



63A

2B636



3B636



230/400V CA

6.0 - 63A (RC) : 6kA

6.0 - 20A (RC) : 80A

25 - 32A (RC) : 100A

40 - 63A (RC) : 125A

20000 ON/OFF operaciones

30°C (86°F)

5/1.4kg (3.1 lb.)

Arriba: 18-3 AWG; 0.5-25mm<sup>2</sup>

Abajo: 18-2 AWG; 0.5-35mm<sup>2</sup>

22 lb.in.; max 2.5 Nm

230/400V CA

6.0 - 63A (RC) : 6kA

6.0 - 20A (RC) : 80A

25 - 32A (RC) : 100A

40 - 63A (RC) : 125A

20000 ON/OFF operaciones

30°C (86°F)

4/1.68kg (3.7 lb.)

Arriba: 18-3 AWG; 0.5-25mm<sup>2</sup>

Abajo: 18-2 AWG; 0.5-35mm<sup>2</sup>

22 lb.in.; max 2.5 Nm

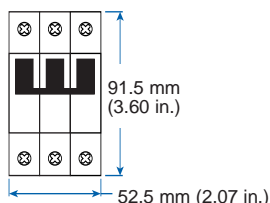
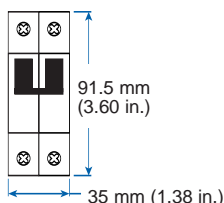

### V-EA-B Disparo 6.0 - 10 Amps

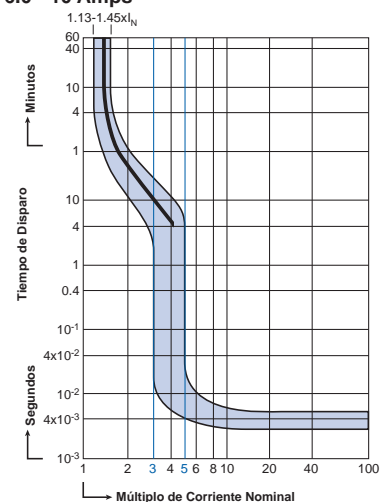

### V-EA-B Disparo 13 - 63 Amps

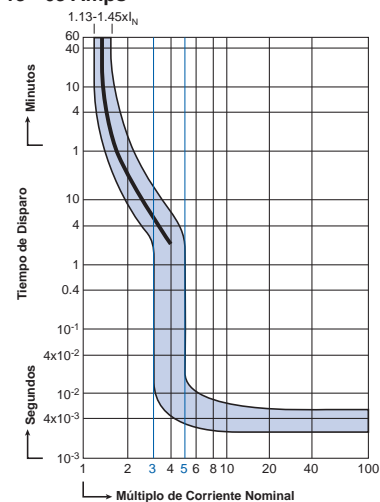

### Parámetros del Disparo Magnético Curva "B"

1. Mantenido por un mínimo de 100ms en sobre tensión ó 3 veces la corriente nominal.
2. Disparo abajo de 100 ms a 5 veces la intensidad nominal.

# Interruptores Miniatura

## CURVA -C CARACTERISTICAS

### Ejem. De aplicación:

Motores de baja demanda, iluminación, protección de cableado, electrodomesticos, equipo de oficina, y aplicaciones de circuitos de control. Con un relativamente largo disparo térmico y disparo magnético medio.

### Normas:

IEC 60898  
EN 60898  
DIN VDE 0641  
IEC 60974-2  
EN 60974-2  
DIN VDE 0660

Nota: Para MCB's con  277Y/480V y clasificación 10 kA por favor contacte con Altech.

### Certificación:



### Clasificación de Voltaje\*

### Capacidad interruptiva (IEC – Clasif.)

### Máximo fusible de respaldo

### De acuerdo a IEC60269

### Durabilidad Mecánica

### Temperatura de calibración

### Paq. Estandar y peso

### Tamaño de terminal aceptada

### Torque de terminal

### Dimensiones básicas (Vista frontal)

\* DC Clasificación (Certificación del fabricante): Un polo 60V CD, dos polos series 125V CD

## UN POLO



1C

## UN POLO MAS NEUTRO



8C

Clasif. Corriente	Código	Aprobación	Código	Aprobación
0.3A	1C0.306		8C0.306	
0.5A	1C0.506		8C0.506	
0.75A	1C0.756		8C0.756	
0.8A	ND		ND	
1.0A	1C1.06		8C1.06	
1.6A	1C1.66		8C1.66	
2.0A	1C2.06		8C2.06	
2.5A	1C2.56		8C2.56	
3.0A	1C3.06		8C3.06	
3.5A	1C3.56		8C3.56	
4.0A	1C4.06		8C4.06	
5.0A	1C5.06		8C5.06	
6.0A	1C6.06		8C6.06	
8.0A	1C8.06		8C8.06	
10A	1C106		8C106	
13A	1C136		8C136	
16A	1C166		8C166	
20A	1C206		8C206	
25A	1C256		8C256	
32A	1C326		8C326	
40A	1C406		8C406	
50A	1C506		8C506	
63A	1C636		8C636	
230V CA			230/400V CA	
0.3 - 63A (RC): 6kA			0.3 - 63A (RC): 6kA	
6.0 - 20A (RC) : 80A			6.0 - 20A (RC) : 80A	
25 - 32A (RC) : 100A			25 - 32A (RC) : 100A	
40 - 63A (RC) : 125A			40 - 63A (RC) : 125A	
20000 ON/OFF operaciones			20000 ON/OFF operaciones	
30°C (86°F)			30°C (86°F)	
10/0.3A - 32A = 1.4kg (3.1 lb.)			10/0.3A - 32A = 1.4kg (3.1 lb.)	
40A - 63A = 1.6kg (3.5 lb.)			40A - 63A = 1.6kg (3.5 lb.)	
Arriba: 18-3 AWG; 0.5-25mm <sup>2</sup>			Arriba: 18-3 AWG; 0.5-25mm <sup>2</sup>	
Abajo: 18-2 AWG; 0.5-35mm <sup>2</sup>			Abajo: 18-2 AWG; 0.5-35mm <sup>2</sup>	
22 lb.in.; 2.5 Nm			22 lb.in.; 2.5 Nm	

## DOS POLOS



2C



## TRES POLOS



3C



### Dimensiones Basicas (vista lateral)

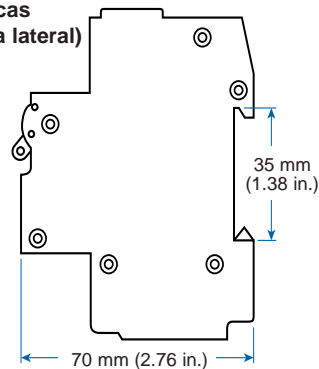

### V-EA-C Disparo 0.3 - 10 Amps

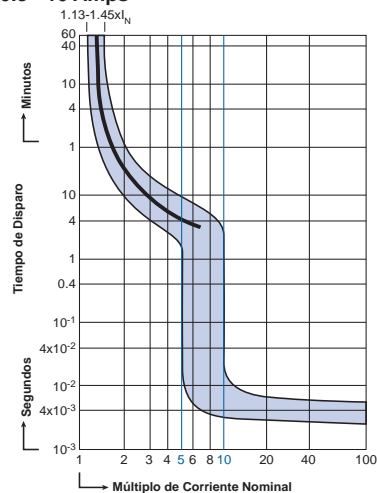

### V-EA-C Disparo 13 - 63 Amps

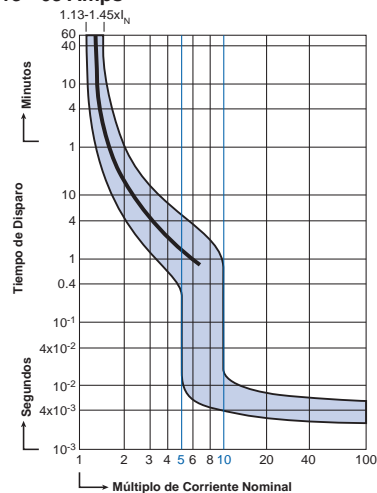

### Parámetros del Disparo Magnético Curva "C"

- Mantenido por un mínimo de 100ms en sobre tensión ó 5 veces la corriente nominal.
- Disparo abajo de 100 ms a 10 veces la intensidad nominal.

Clasif. Corriente	Código	Aprobación	Código	Aprobación
0.3A	2C0.306		3C0.306	
0.5A	2C0.506		3C0.506	
0.75A	2C0.756		3C0.756	
0.8A	ND		ND	
1.0A	2C1.06		3C1.06	
1.6A	2C1.66		3C1.66	
2.0A	2C2.06		3C2.06	
2.5A	2C2.56		3C2.56	
3.0A	2C3.06		3C3.06	
3.5A	2C3.56		3C3.56	
4.0A	2C4.06		3C4.06	
5.0A	2C5.06		3C5.06	
6.0A	2C6.06		3C6.06	
8.0A	2C8.06		3C8.06	
10A	2C106		3C106	
13A	2C136		3C136	
16A	2C166		3C166	
20A	2C206		3C206	
25A	2C256		3C256	
32A	2C326		3C326	
40A	2C406		3C406	
50A	2C506		3C506	
63A	2C636		3C636	
230/400V CA			230/400V CA	
0.3 - 63A (RC): 6kA			0.3 - 63A (RC): 6kA	
6.0 - 20A (RC): 80A			6.0 - 20A (RC): 80A	
25 - 32A (RC): 100A			25 - 32A (RC): 100A	
40 - 63A (RC): 125A			40 - 63A (RC): 125A	
20000 ON/OFF operaciones			20000 ON/OFF operaciones	
30°C (86°F)			30°C (86°F)	
5/1.4kg (3.1 lb.)			4/1.68kg (3.7 lb.)	
Arriba: 18-3 AWG; 0.5-25mm <sup>2</sup>			Arriba: 18-3 AWG; 0.5-25mm <sup>2</sup>	
Abajo: 18-2 AWG; 0.5-35mm <sup>2</sup>			Abajo: 18-2 AWG; 0.5-35mm <sup>2</sup>	
22 lb.in.; 2.5 Nm			22 lb.in.; 2.5 Nm	

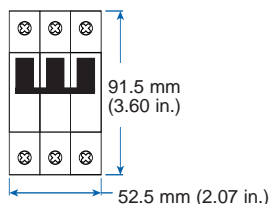
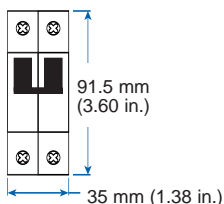



## FA Disparador a Distancia

Código	Voltaje de Disparo/ Bobina	Max. Corriente Bobina
FA12U	12V	1.3A
FA24U	24V	0.6A
FA48U	48-72V	0.2A
FA110U	110-240V	0.25-0.5A
FA110U	380-415V CA	0.8A

Paq. Std.: 1

Peso unitario: 120 gramos (0.27 lb.)

Ancho: 17.5mm (.689in.)



## UA Disparador de Bajo Voltaje

Código	Voltaje de línea 50/60Hz
UA.24	24V CA
UA220	220V CA
UA240	240V CA
UA380	380V CA
UA415	415V CA

Paq. Std.: 1

Peso unitario: 70 gramos (0.16 lb.)

Ancho: 17.5mm (.689in.)



## H11U Contacto Auxiliar

Clasificación de contacto

Código	H11U
	10A / 220V CA
	3A / 110V CD
	1A / 220V CD

Calibre de Conductor (max.)

4mm<sup>2</sup> (12 AWG)



## Portacandado

Previene el arranque inadvertido de los interruptores durante el mantenimiento.

Código	EASS
--------	------

## Interruptores de Corriente de Falla a Tierra

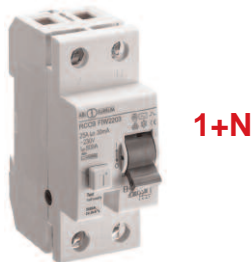

1+N



3+N

Código	Corriente Nominal	Corriente de falla
FIW22.03	25A	30mA
FIW23.03	40A	30mA

Código	Corriente Nominal	Corriente de falla
FIW42.03	25A	30mA
FIW43.03	40A	30mA
FIW44.03	63A	30mA

Nota: para una corriente de falla a tierra igual a 100mA o 300mA consulte a Altech.

## 1 fase Busbar

Normas: IEC 664  
VDE 0660, 0606, 0659

80A/500V  
para 100A/500V consulte a Altech

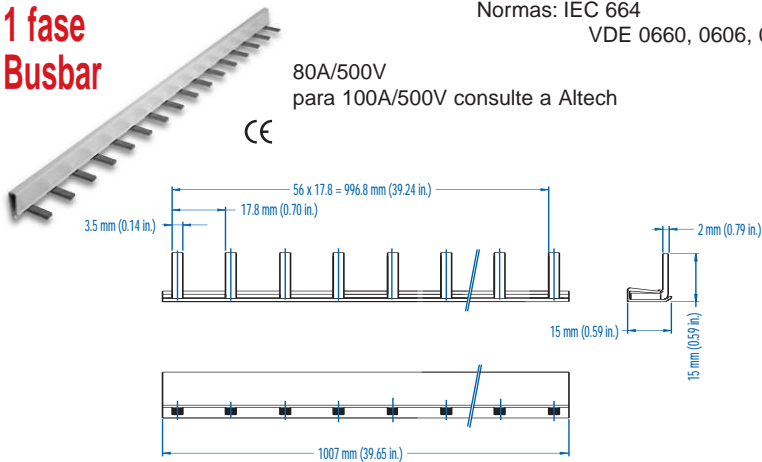

18mm <sup>2</sup> Código	No. de Pins	No. Máx. de Interruptores	largo/ mm
1P181/12	12	12x1 polos	208
1P181/57	57	57x1 polos	1007

## Terminal Alimentadora de Potencia

P50UT

125A/500V

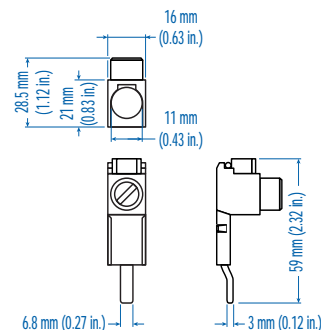

## 2 fases Busbar

80A/500V  
para 100A/500V consulte a Altech

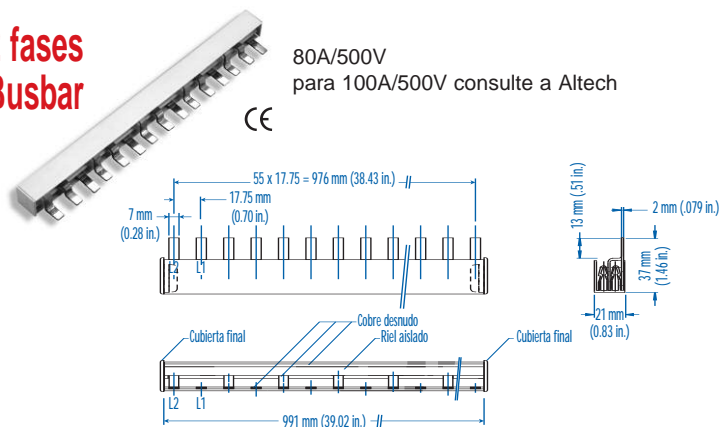

18mm <sup>2</sup> Código	No. de Pins	No. Máx. de Interruptores	largo/ mm
2P183/12	12	6x2 polos	208
2P183/56	56	28x2 polos	991

## Block Alimentador de Potencia

P95UB

200A/500V

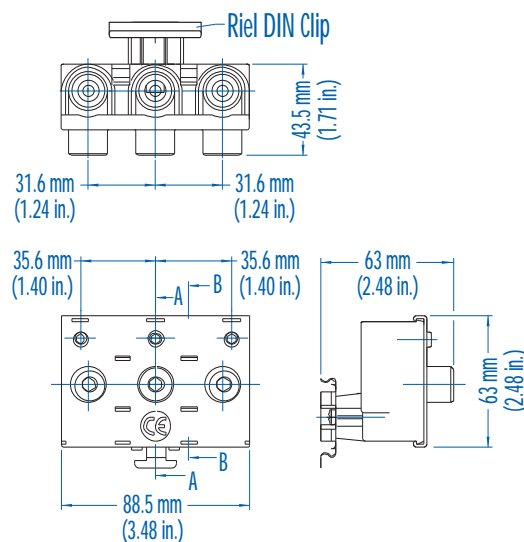

## 3 fases Busbar

80A/500V  
para 100A/500V consulte a Altech

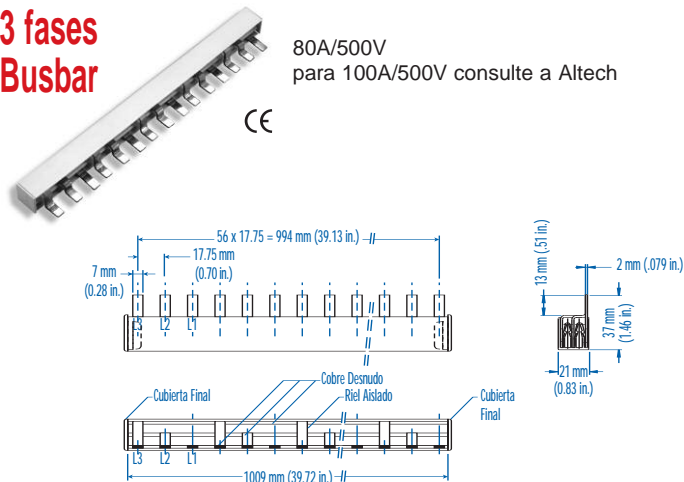

18mm <sup>2</sup> Código	No. de Pins	No. Máx. de Interruptores	largo/ mm
3P183/12	12	4x3 polos	208
3P183/57	57	19x3 polos	1009