

Electrically Tuned Attenuator

P/N: JXWBSJ-T-1000-2000-50D

Frequency Range(GHz)	1-2
Insertion Loss(dB)	1 max
Input/Output VSWR	2:1 max(Attenuation:0-40dB) 2.3:1 max(Attenuation:40-50dB)
Attenuation(dB)	50 min
Attenuation Flatness (dB)	±0.4 max(Attenuation<10dB) ±0.6 max(Attenuation:10-20dB) ±1.2 max(Attenuation:20-30dB) ±1.5 max(Attenuation:30-40dB) ±2.0 max(Attenuation:40-50dB)
Control Current(mA)	0-40
Input Power(W)	1 CW
Connector	SMA-Female(Customization is available)
Operating Temperature(°C)	-55 ~ +80
Storage Temperature(°C)	-65 ~ +120
Case	30 x 19 x 9

Outline Drawing (Size: mm)

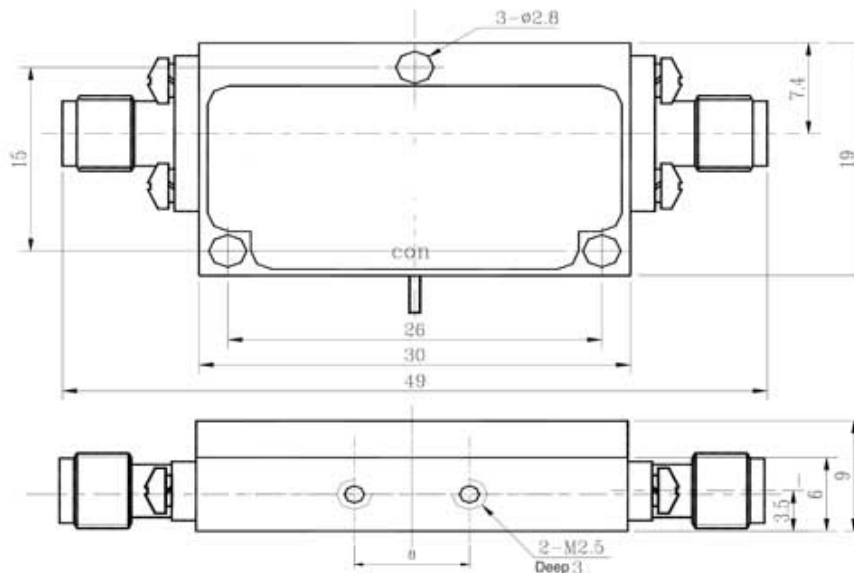

Data subject is to change without notice. For current data sheets, please contact: sales@aacix.com