

# SPECIFICATION FOR APPROVAL

PROD. NAME	SHIELDED SMD POWER INDUCTOR	ABC'S DWG NO.	BS0704□□□□F□-□□□
		ABC'S ITEM NO.	

## I . MECHANICAL DIMENSIONS :

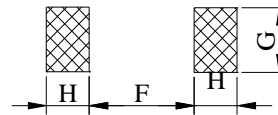
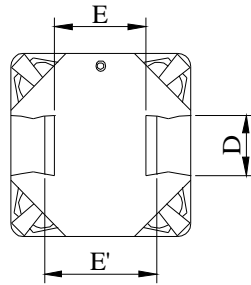
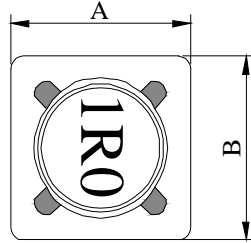

( PCB Pattern )

- A : 7.30 ± 0.2 m/m
- B : 7.30 ± 0.2 m/m
- C : 4.50 ± 0.2 m/m
- D : 2.00 typ. m/m
- E : 4.60 typ. m/m
- E' : 4.90 typ. m/m
- F : 4.80 typ. m/m
- G : 2.40 ref m/m
- H : 1.50 ref m/m

## II . SCHEMATIC DIAGRAM :

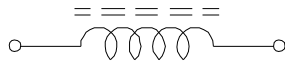

## III . MATERIALS LIST :

- a . Core : Ferrite DR core
- b . Core : Ferrite RI core
- c . Wire : Enamelled copper wire ( class H )
- d . Terminal : Cu/Ni/Sn
- e . Base : LCP Base
- f . Adhesive : Epoxy resin
- g . Remark : Products comply with RoHS' requirements

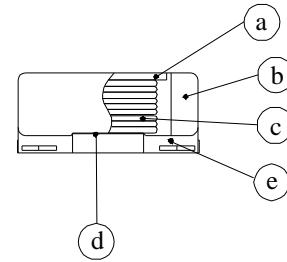

Peak Temp : 260°C max.  
 Max time above 230°C : 50sec max.  
 Max time above 200°C : 70sec max.

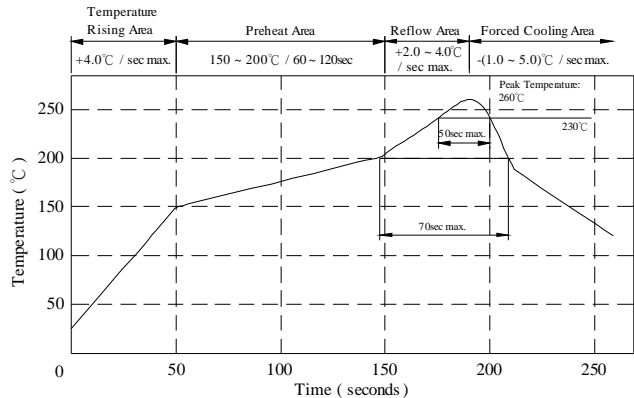

## IV . ELECTRICAL CHARACTERISTICS :

- a . Temp. rise : 40°C max.
- b . Storage temp. : -40°C ----+125°C
- c . Operating temp. : -25°C ----+105°C
- d . Resistance to solder heat : 260°C . 10 secs.

# SPECIFICATION FOR APPROVAL

REF : 20100112-A

PAGE: 2

PROD. NAME	SHIELDED SMD POWER INDUCTOR	ABC'S DWG NO.	BS0704□□□□F□-□□□
		ABC'S ITEM NO.	

### V . ELECTRICAL CHARACTERISTICS :

DWG No.	Inductance (uH)	Test Freq. (Hz) / 1V	RDC (Ω) max.	Irms (A)	Isat (A)
BS07041R0MF□ -□□□	1.0±20%	1K	0.013	5.00	5.60
BS07042R2MF□ -□□□	2.2±20%	1K	0.018	4.20	5.00
BS07043R3MF□ -□□□	3.3±20%	1K	0.022	3.80	4.40
BS07044R7MF□ -□□□	4.7±20%	1K	0.028	3.60	4.00
BS07045R6MF□ -□□□	5.6±20%	1K	0.032	3.00	3.40
BS07046R8MF□ -□□□	6.8±20%	1K	0.040	2.80	3.20
BS0704100MF□ -□□□	10.0±20%	1K	0.052	2.10	2.50
BS0704120MF□ -□□□	12.0±20%	1K	0.062	2.00	2.30
BS0704150MF□ -□□□	15.0±20%	1K	0.075	1.90	2.10
BS0704180MF□ -□□□	18.0±20%	1K	0.090	1.80	1.95
BS0704220MF□ -□□□	22.0±20%	1K	0.096	1.65	1.75
BS0704270MF□ -□□□	27.0±20%	1K	0.130	1.45	1.62
BS0704330MF□ -□□□	33.0±20%	1K	0.150	1.35	1.45
BS0704390MF□ -□□□	39.0±20%	1K	0.190	1.17	1.30
BS0704470MF□ -□□□	47.0±20%	1K	0.210	1.05	1.20
BS0704560MF□ -□□□	56.0±20%	1K	0.240	0.95	1.10
BS0704680MF□ -□□□	68.0±20%	1K	0.300	0.86	0.96
BS0704820MF□ -□□□	82.0±20%	1K	0.400	0.78	0.90
BS0704101MF□ -□□□	100.0±20%	1K	0.450	0.70	0.78
BS0704121MF□ -□□□	120.0±20%	1K	0.550	0.60	0.70
BS0704151MF□ -□□□	150.0±20%	1K	0.760	0.48	0.58
BS0704181MF□ -□□□	180.0±20%	1K	0.820	0.46	0.54
BS0704221MF□ -□□□	220.0±20%	1K	0.950	0.42	0.50
BS0704271MF□ -□□□	270.0±20%	1K	1.200	0.38	0.46
BS0704331MF□ -□□□	330.0±20%	1K	1.500	0.34	0.40
BS0704391MF□ -□□□	390.0±20%	1K	1.850	0.32	0.36
BS0704471MF□ -□□□	470.0±20%	1K	2.200	0.29	0.34
BS0704561MF□ -□□□	560.0±20%	1K	2.600	0.26	0.30
BS0704681MF□ -□□□	680.0±20%	1K	2.800	0.24	0.28
BS0704821MF□ -□□□	820.0±20%	1K	3.500	0.22	0.26
BS0704102MF□ -□□□	1000.0±20%	1K	4.100	0.20	0.24

- 1). □: Packaging Information...  Bulk  Taping Reel
- 2)."-□□□":Reference code
- 3). L Test Freq. : 1KHz / 1V
- 4). Irms base on Temp. rise 40°C max.
- 5). Isat base on ΔL/L0A=25% max.

AR-001A



# SPECIFICATION FOR APPROVAL

REF: 20100112-A

PAGE: 3

PROD.	SHIELDED SMD	ABC'S DWG NO.	BS0704□□□□F□-□□□
NAME	POWER INDUCTOR	ABC'S ITEM NO.	

VI . Inductance VS DC Current Curve :

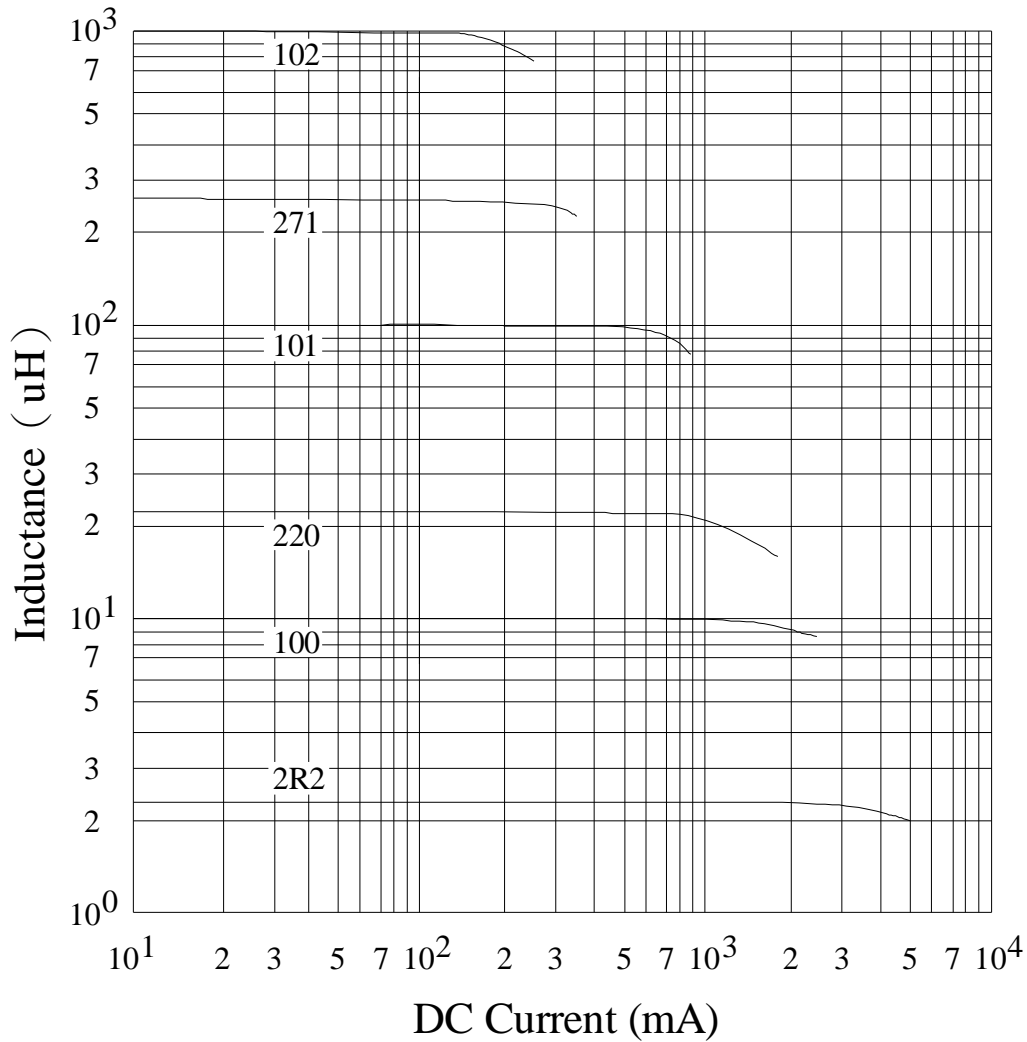

AR-001A



# SPECIFICATION FOR APPROVAL

REF: 20100112-A

PAGE: 4

PROD. NAME	SHIELDED SMD POWER INDUCTOR	ABC'S DWG NO.	BS0704□□□□F□-□□□
		ABC'S ITEM NO.	

## VII . PACKAGING INFORMATION :

### ( 1 ) Configuration

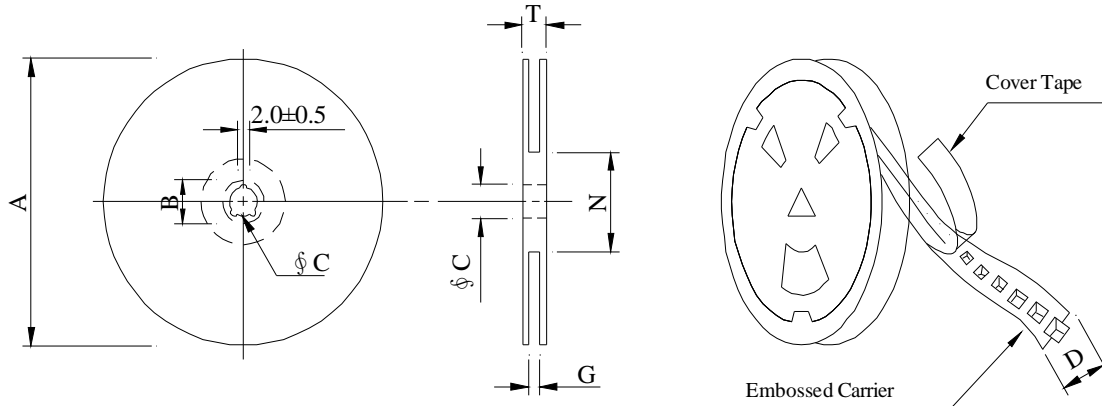

※Carrier Tape Width : D

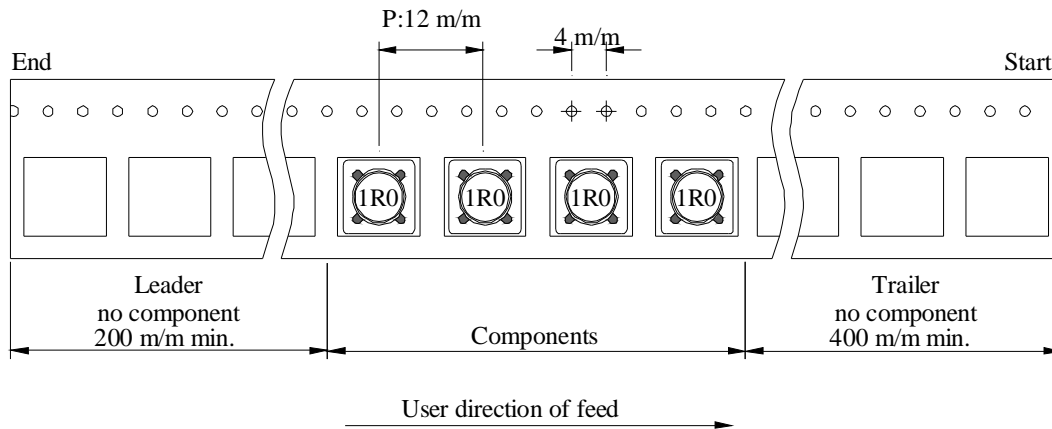

### ( 2 ) Dimensions

Unit:m/m

Style	A	B	C	D	G	N	T
13 - 16	330	21±0.8	13±0.5	16	18 <sup>+0</sup>	50 <sup>-0</sup>	22.4

### ( 3 ) Q'TY & G.W. Per package

Series	Inner : Reel			Outer : Carton		
	Q'TY (pcs)	G.W. (gw)	Style	Q'TY (pcs)	G.W. (Kg)	Size (cm)
BS0704-F	1,000	825	13 - 16	6,000	11.6	40 x 40 x 24

AR-001A

# SPECIFICATION FOR APPROVAL

REF: 20100112-A

PAGE: 5

PROD. NAME	SHIELDED SMD POWER INDUCTOR	ABC'S DWG NO.	BS0704□□□□F□-□□□
		ABC'S ITEM NO.	

**VIII . DWGING NUMBER EXPRESSION :**

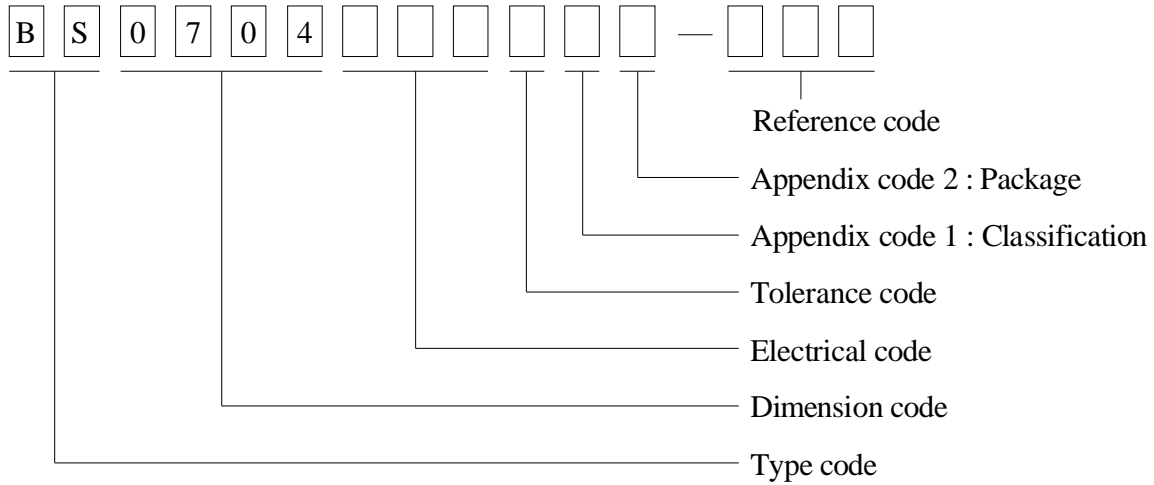

**Appendix code 1 : Product Classification**

- F : Lead Free Standard products comply with RoHS' requirements
- 1 ~ 9 : Lead Free Special products comply with RoHS' requirements

**Appendix code 2 : Package Information**

Code	Inner package	Inner package Q'TY	Remark
A	T.B.D.	T.B.D.	
B	T / R ( Reel package )	1000 pcs	

# SPECIFICATION FOR APPROVAL

REF : 20100112-A

PAGE: 6

PROD. NAME	SHIELDED SMD POWER INDUCTOR	ABC'S DWG NO. ABC'S ITEM NO.	BS0704□□□□F□-□□□
---------------	--------------------------------	---------------------------------	------------------

**IX . RELIABILITY TEST :**

Test item	Specification	Test condition						
Solderability	More than 95% of the terminal electrode shall be covered With fresh solder.	Preheat : 155°C / 4 hours. Solder : Sn96.5 / Ag3 / Cu0.5 or equivalent Solder temp. : 235±5°C Flux : Rosin Dip time : 5±0.5 seconds						
Thermal shock test ( Temp. cycle )	Electrical oharacteristics shall not change more than ±20%	<table style="width: 100%; border: none;"> <tr> <td style="border: none;">Room temp. 15 minutes</td> <td style="border: none; text-align: center;">→</td> <td style="border: none; text-align: center;">-25 °C 30 minutes</td> </tr> <tr> <td style="border: none;">Room temp. 15 minutes</td> <td style="border: none; text-align: center;">→</td> <td style="border: none; text-align: center;">+105 °C 30 minutes</td> </tr> </table> <p>Total : 50 cycles</p>	Room temp. 15 minutes	→	-25 °C 30 minutes	Room temp. 15 minutes	→	+105 °C 30 minutes
Room temp. 15 minutes	→	-25 °C 30 minutes						
Room temp. 15 minutes	→	+105 °C 30 minutes						
Humidity Test		Temperature : 40±2°C Humidity : 90±5% Time : 1000 hours						
High temp. Resistance test		Temperature : 105±5°C Applied current : Per spec. Time : 96 hours						

AR-001A

# SPECIFICATION FOR APPROVAL

REF : 20100112-A

PAGE: 7

PROD. NAME	SHIELDED SMD POWER INDUCTOR	ABC'S DWG NO. ABC'S ITEM NO.	BS0704□□□□F□-□□□
---------------	--------------------------------	---------------------------------	------------------

X . UL CARD :

OBMW2 October 06, 2005

Magnet Wire-Component

**ELEKTRISOLA (MALAYSLA) SDN BHD** E143312

JALAN DAMAI SATU JANDA BAIK 28750 BENTONG, PAHANG  
DARUL MAKMUR MALAYSIA

Mtl Dsg	Mark Dsg	Coating Type		ANSI Typ	Temp Class
		BC	OC		
Estersol 180	E180	Polyesterimide (solderable)	---	MW-77	180
Amldester 200	A200	Polyesterimide	---	MW-74	200
Polysol-N 155	PN155	Polyurethane	Nylon	MW-80, MW-28	155, 130
Polysol 155	P155, G155	Polyurethane	---	MW-79, MW-75	155, 130
Polysol 155g	Pg155	Polyurethane	---	MW-75	130
Polysol 155p	Pp155, Gp155	Polyurethane	---	MW-79	155
Polysol 160	P160	Polyurethane	---	MW-79	155
Polysol 180	P180, G180	Polyurethane	---	MW-82, MW-79	180, 155
Polysol 170	P170 or G170	Polyurethane	---	MW-79	155
Polysol-N 180	PN180	Polyurethane	Nylon	MW-83	180
Polysol P155p	P155p	Polyurethane	---	MW-79	155

Marking : Company name, material designation or marked designation and factory identification on package ok reel

---

See General Information preceding These Recognitions  
For use only in equipment where the acceptability of the combination is determined by Underwriters Laboratories Inc.

**SUMITOMO CHEMICAL CO LTD** E54705 (M)

5-33 KITAHAMA 4-CHOME CHUO-KO, OSAKA JAPAN

Mtl Dsg	Col	Min Thk mm	UL94 Flame Class	Elec	RTI Mech with Imp	w/o Imp	H		D		C
							W I	A I	V T R	4 9 5	
Liquid crystal polyester (LCP), designated "EKONOL" or "SUMIKASUPER", furnished in the form of pellets, (Contd)											
E4008, E400X	NC, BK	0.30	94V-0	130	130	130	---	---	---	---	---
		0.75	94V-0	130	130	130	3	4	---	---	---
		1.5	94V-0	130	130	130	2	4	---	---	---
		3.0	94V-0	130	130	130	1	4	0	5	4
E4008	NC, WT, BK	0.30	94V-0	130	130	130	---	---	---	---	---
		0.75	94V-0	220	180	220	3	4	---	---	---
		1.5	94V-0	220	200	240	2	4	---	---	---
		3.0	94V-0	220	200	240	1	4	0	5	4
E4010	NC, BK	0.30	94V-0	130	130	130	---	---	---	---	---
		0.75	94V-0	220	180	220	3	4	---	---	---
		1.5	94V-0	220	200	240	2	4	---	---	---
		3.0	94V-0	220	200	240	1	4	0	5	4
E400(Y)L, E4008L	NC, BK	0.30	94V-0	130	130	130	---	---	---	---	---
		0.75	94V-0	130	130	130	3	4	---	---	---
		1.5	94V-0	130	130	130	2	4	---	---	---
		3.0	94V-0	130	130	130	1	4	0	5	4
E4810	NC, BK	0.30	94V-0	130	130	130	---	---	---	---	---
		0.75	94V-0	130	130	130	0	4	---	---	---
		1.5	94V-0	130	130	130	0	4	---	---	---
		3.0	94V-0	130	130	130	1	4	0	5	4

(X) Denotes any number 1 thru 9.  
(Y) Denotes any number 1 thru 7.

AR-001A

