

FEATURES:

- POL delivering 10A output current
- Programmable output voltage
- Remote output sense
- Remote On/Off Control Function
- Output Over current protection
- Over temperature protection
- Operating temperature -40 to 85°C
- Industry standard SMD footprint

Models
Single output

Model	Nom. Input Voltage (V)	Output Voltage (V)	Output Current max (A)	Efficiency (%)
AMPL-0510-UZ	5	0.75, 1, 1.2, 1.5, 1.8, 2, 2.5, 3.3	10	97
AMPL-1210-UZ	12	0.75, 1, 1.2, 1.5, 1.8, 2, 2.5, 3.3, 5	10	96

Input Specifications

Parameters	Nominal	Typical	Maximum	Units
Voltage range	5	3~5.5		V
	12	10~14		

Output Specifications

Parameters	Conditions	Typical	Maximum	Units
Set point Voltage accuracy		±2		%
Trim range	Full Resistive load	0.75~3.63		V
Remote sense compensation		0.5		V
Short Circuit protection	R<10Ω		Continuous	
Short Circuit restart			Auto recovery	
Line voltage regulation	Full Resistive load	±0.5		% of Vin
Load voltage regulation	NL-FL	±0.5		%
Turn-on delay time	Full Resistive load	2		ms
Rise time	(0.1~0.9) of Vout	1.5		ms
Temperature coefficient		±0.02		%/°C
Ripple & Noise	At 20MHz Bandwidth	50		m Vp-p
Load transient voltage		160		mV
Setting time	Vout < 10% Peak Deviation	50		μs
Maximum capacitive load	Min ESR >10mΩ		5000	μF

General Specifications

Parameters	Conditions	Typical	Maximum	Units
Switching frequency	100% load	300		KHz
Operating temperature		-40 to +85		°C
Storage temperature		-55 to +125		°C
Cooling		Free air convection		
Humidity		10 ~ 90		%
Weight			7	g
Dimensions (L x W x H)		1.30 x 0.53 x 0.27 inches	33.00 x 13.46 x 6.70mm	
MTBF		> 5,000,000hrs, Bellcore TR332, 25 °C		

NOTE: All specifications in this datasheet are measured at an ambient temperature of 25°C, humidity<75%, nominal input voltage and at rated output load unless otherwise specified.

Pin Out Specifications

Pin	Single
1	+V Input
2	On/Off Control
3	Sense
4	Trim
5	+V out
6	GND

Dimensions

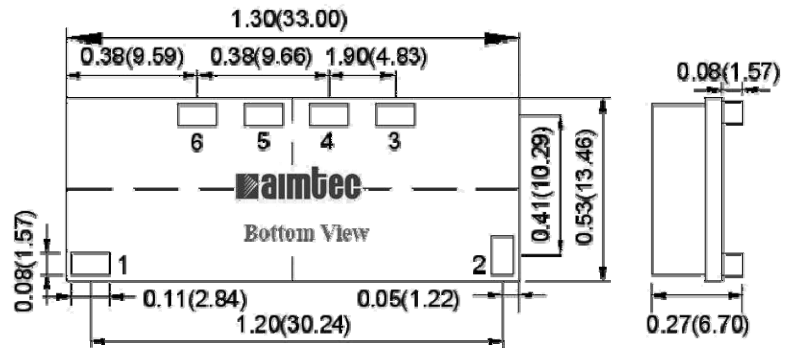

Voltage Adjustment

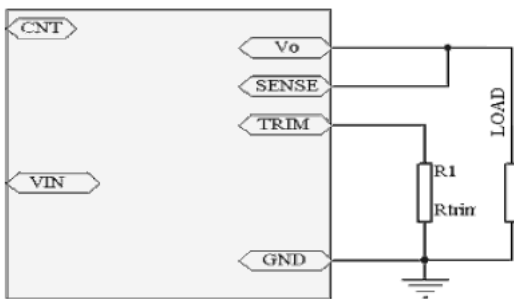

Vout (VDC)	R trim value in KΩ for 3~5.5V Vin (VDC)	R trim value in KΩ for 10~14V Vin (VDC)
0.75	Open	Open
1.0	80.6	41.2
1.2	42.2	22.6
1.5	23.2	13
1.8	15	9.09
2.0	11.8	7.32
2.5	6.98	4.99
3.3	3.16	3.09
5.0	2.21	1.47

Typical Application:

With not using a Control function:

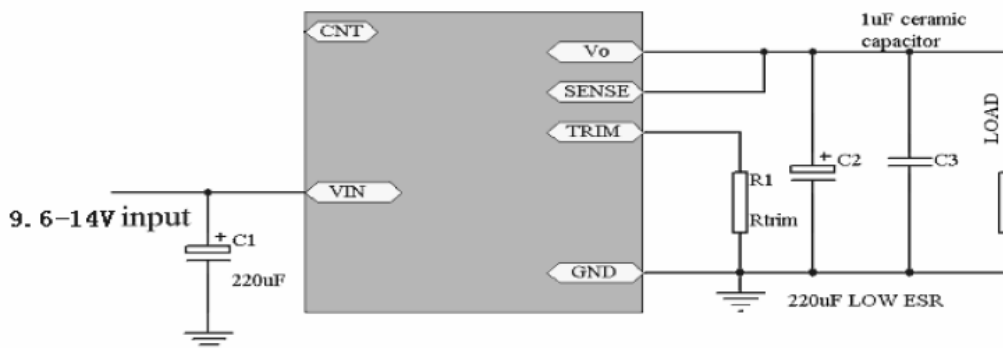

With using a Control option:

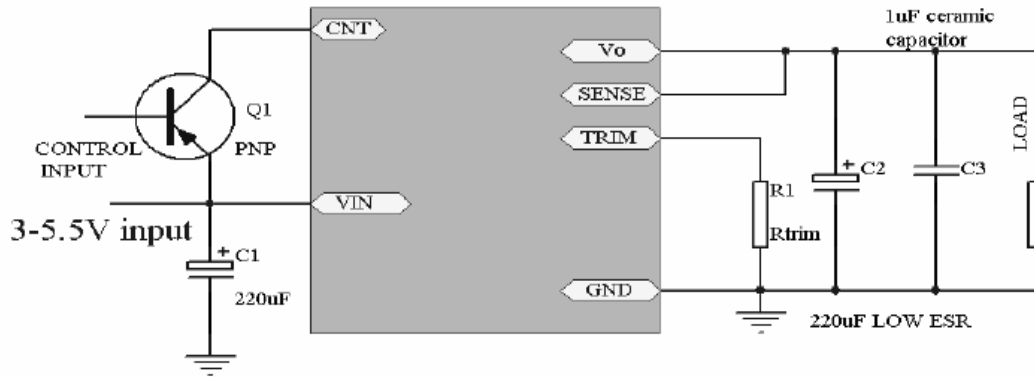

Output ripple and Noise Measurement – test set up:

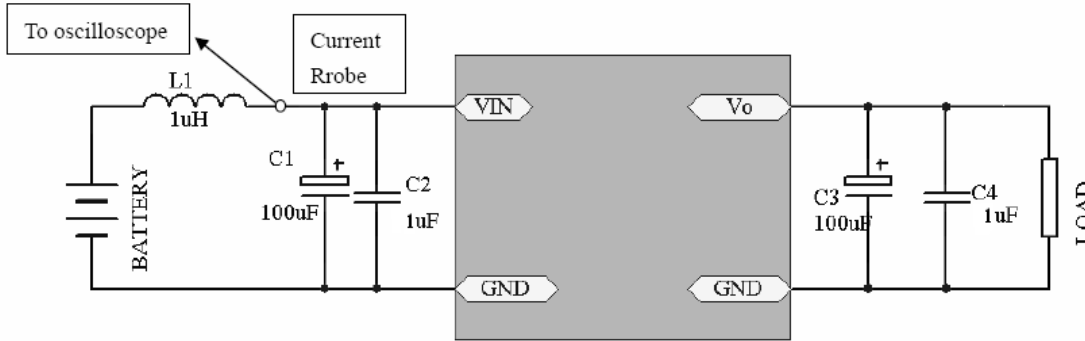

Note: This test set up configuration for measuring the output voltage ripple and the reflected input ripple current is using C1 and C3 tantalum capacitors with ESR<150mΩ and C2 and C4 ceramic capacitors.

Efficiency curves versus load current, at 3 ~ 5.5V input for each output voltage setting (25°C):

Vout 0.75V:

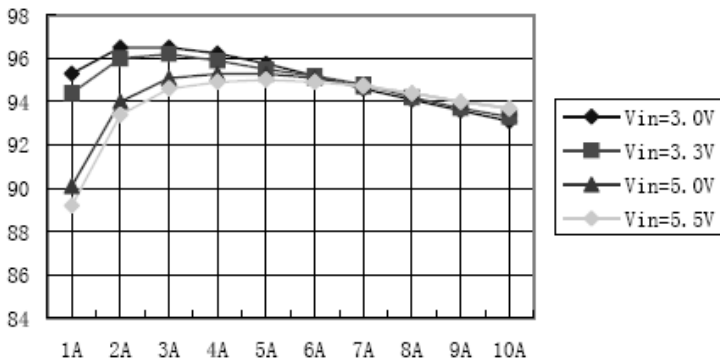

Vout 1V:

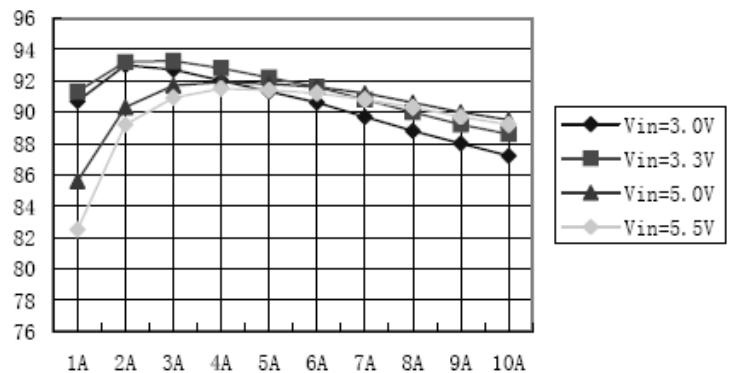

Efficiency curves versus load current, at 3 ~ 5.5V input for each output voltage setting (25°C):
(continued):

Vout 1.2V

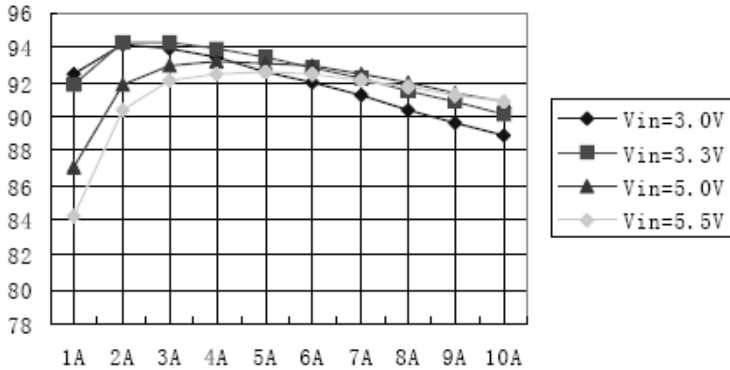

Vout 1.5V

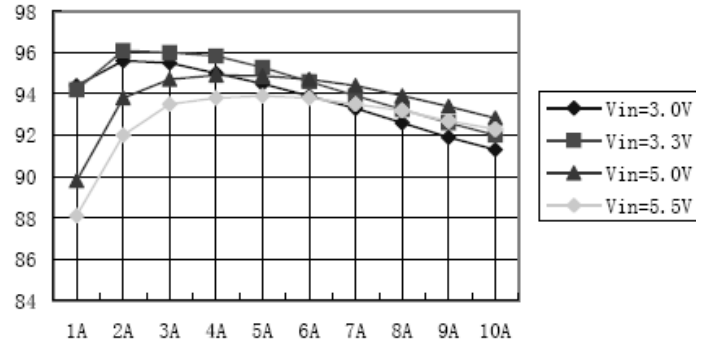

Vout 1.8V

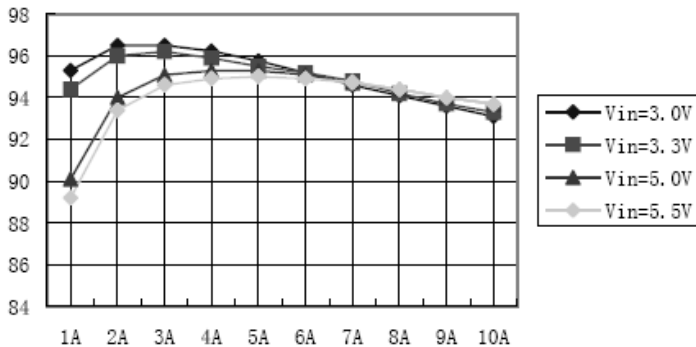

Vout 2V

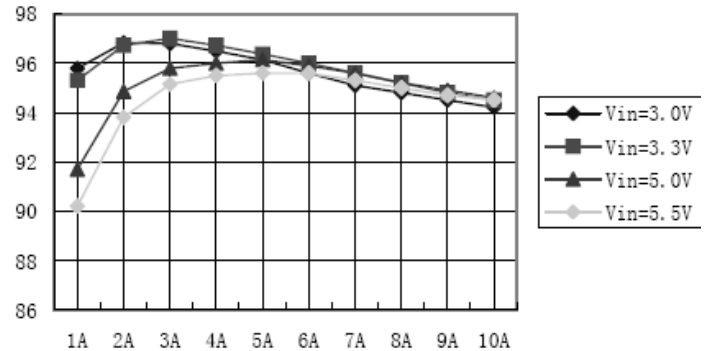

Vout 2.5V

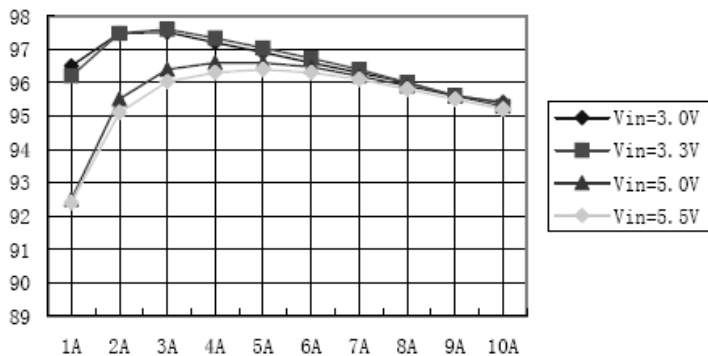

Vout 3.3V

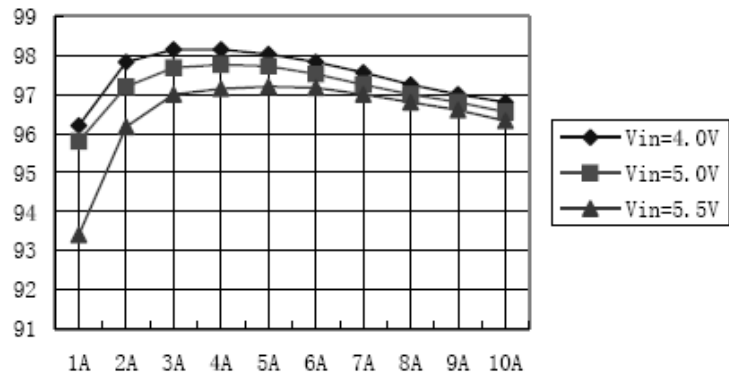

Derating curve at 3 ~ 5.5V input:

Vout 0.75, 1, 1.2, 1.5V:

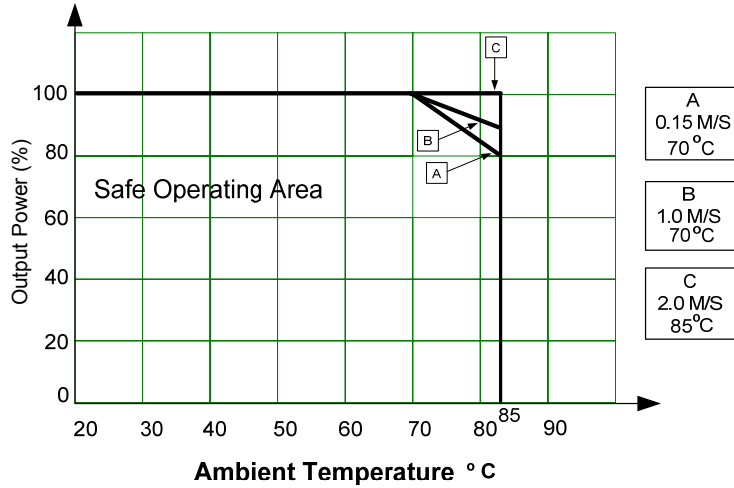

Vout 1.8, 2V

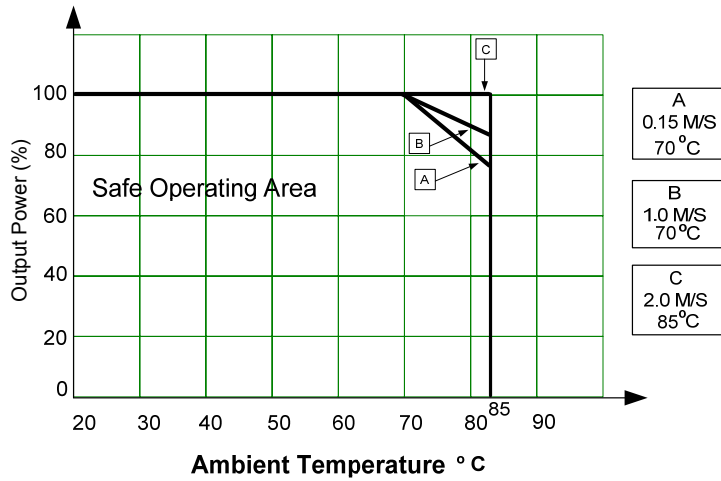

Vout 2.5, 3.3V

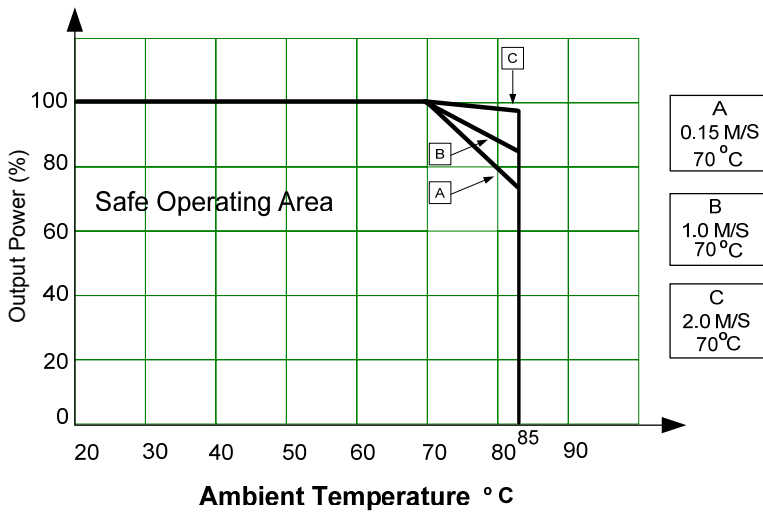

Efficiency curves versus load current, at 10 ~ 14V input for each output voltage setting (25°C):

Vout 0.75V:

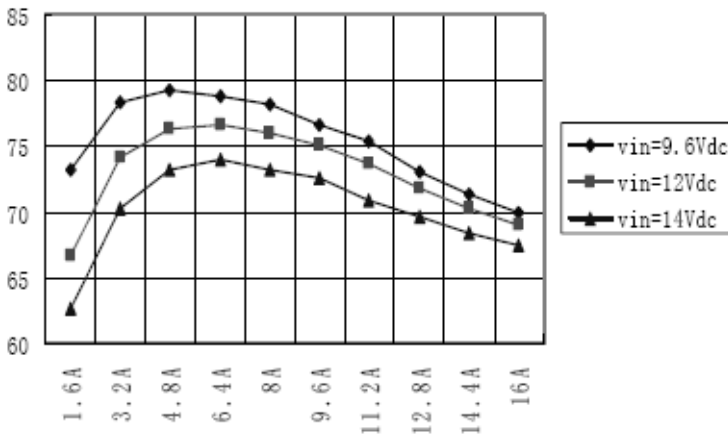

Vout 1V:

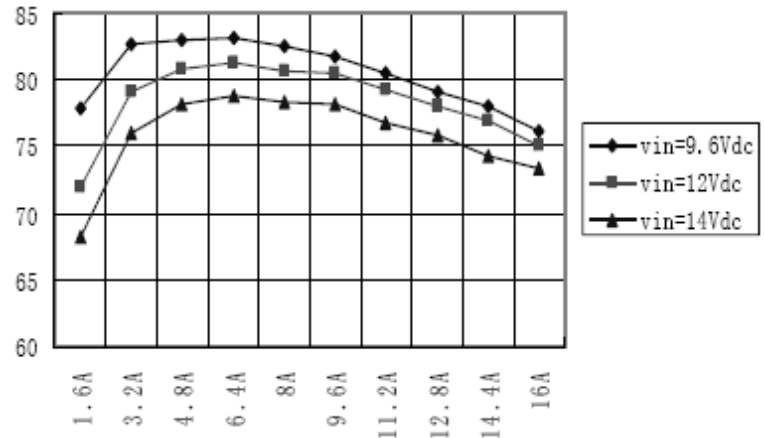

Vout 1.2V:

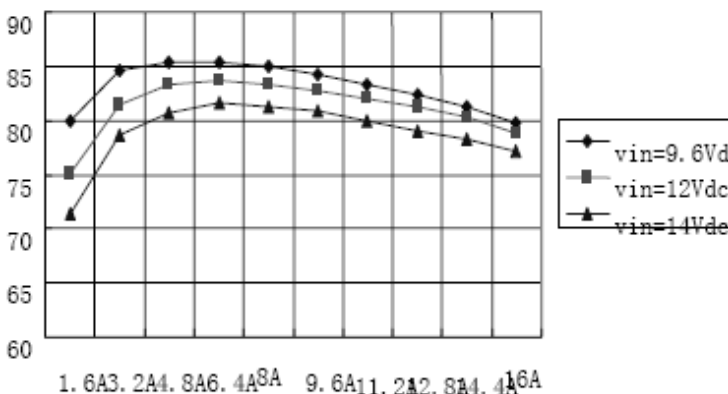

Vout 1.5V:

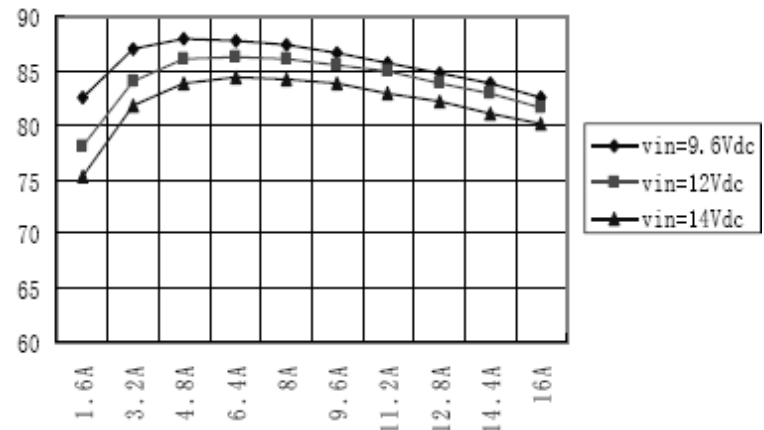

Efficiency curves versus load current, at 10 ~ 14V input for each output voltage setting (25°C)
(continued):

Vout 1.8V

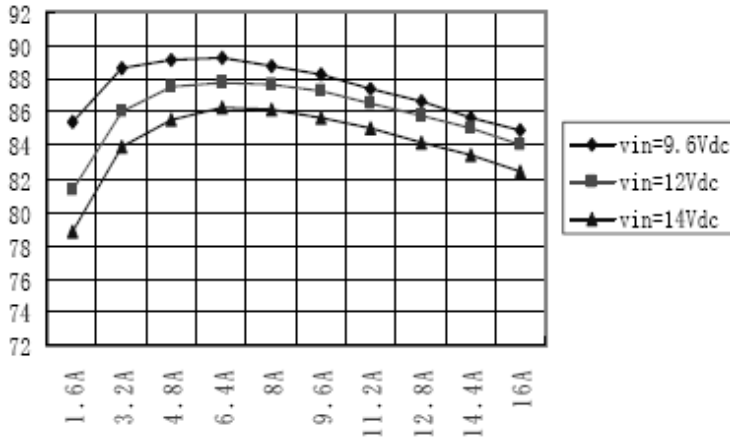

Vout 2V

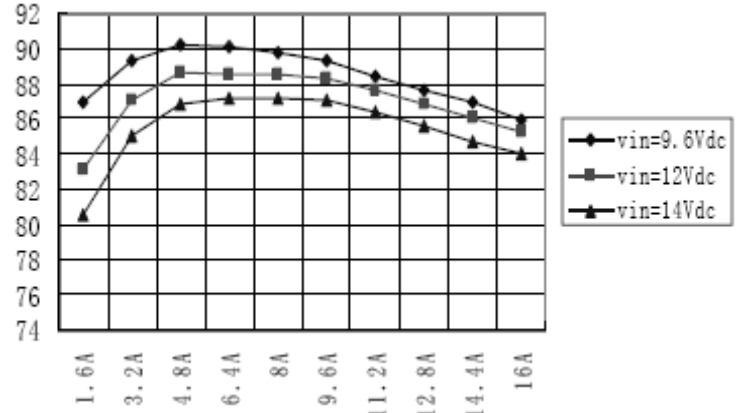

Vout 2.5V

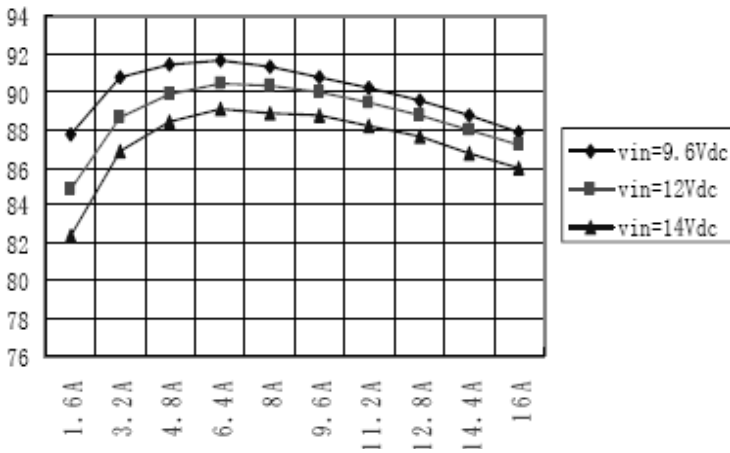

Vout 3.3V

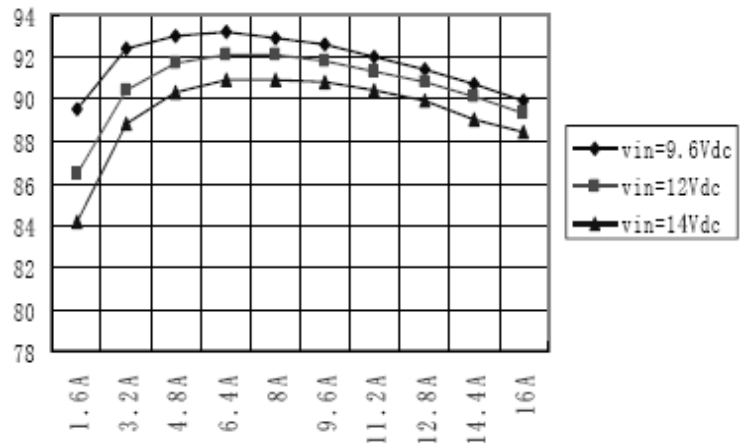

Vout 5V

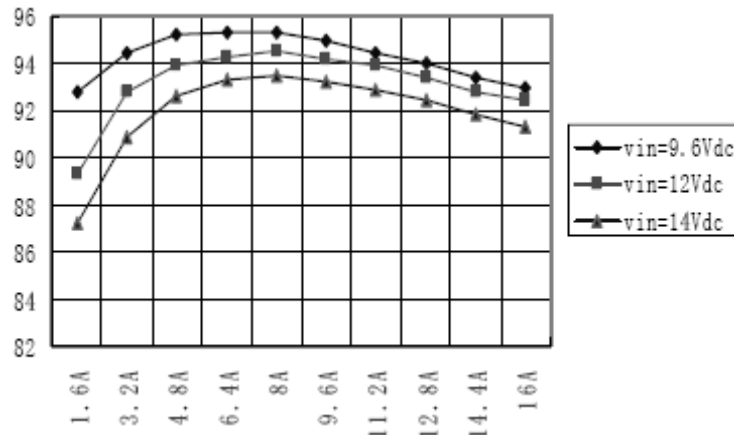

Derating curve at 10 ~ 14V input:

Vout 0.75, 1, 1.2, 1.5V:

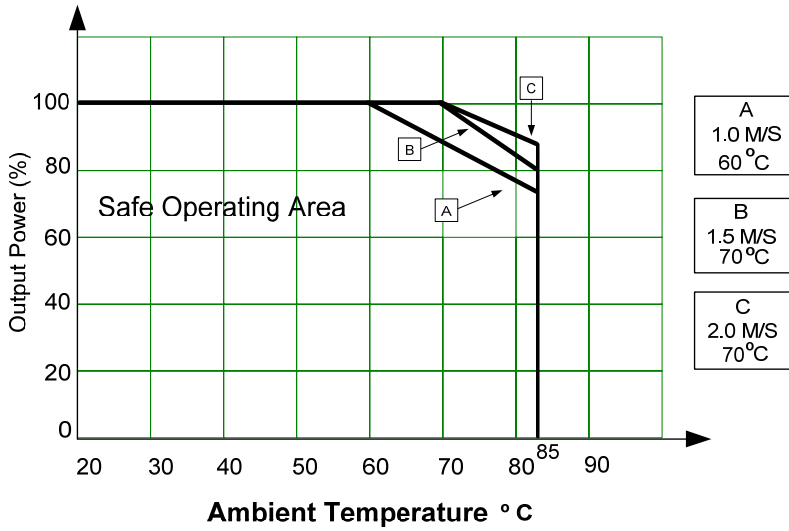

Vout 1.8, 2, 2.5V

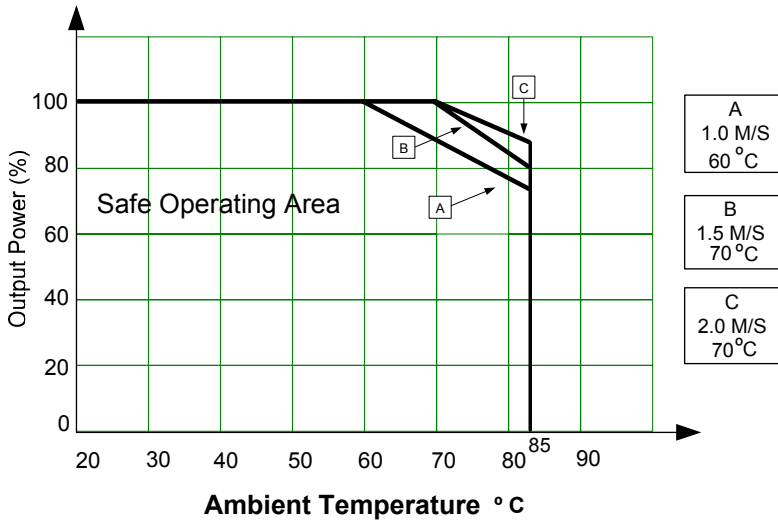

Derating curve at 10 ~ 14V input (continued):

Vout 3.3, 5V

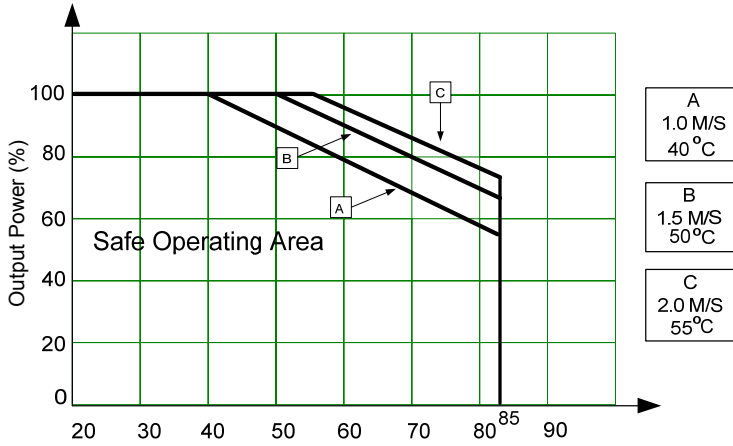

NOTE: **1.** Datasheets are updated as needed and as such, specifications are subject to change without notice. Once printed or downloaded, datasheets are no longer controlled by Aimtec; refer to www.aimtec.com for the most current product specifications. **2.** Product labels shown, including safety agency certifications on labels, may vary based on the date manufactured. **3.** Mechanical drawings and specifications are for reference only. **4.** All specifications are measured at an ambient temperature of 25°C, humidity<75%, nominal input voltage and at rated output load unless otherwise specified. **5.** Aimtec may not have conducted destructive testing or chemical analysis on all internal components and chemicals at the time of publishing this document. CAS numbers and other limited information are considered proprietary and may not be available for release. **5.** This product is not designed for use in critical life support systems, equipment used in hazardous environments, nuclear control systems or other such applications which necessitate specific safety and regulatory standards other the ones listed in this datasheet.