

Silicon NPN Power Transistors

2SC4512

DESCRIPTION

With TO-220C package

·Complement to type 2SA1726

APPLICATIONS

·Audio and General Purpose

PINNING

PIN	DESCRIPTION
1	Base
2	Collector;connected to mounting base
3	Emitter

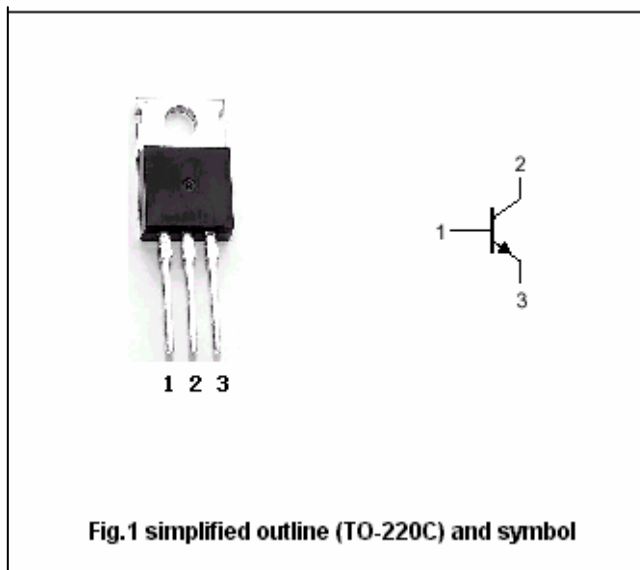

Fig.1 simplified outline (TO-220C) and symbol

Absolute maximum ratings(Ta=25℃)

SYMBOL	PARAMETER	CONDITIONS	VALUE	UNIT
V _{CBO}	Collector-base voltage	Open emitter	120	V
V _{CEO}	Collector-emitter voltage	Open base	80	V
V _{EBO}	Emitter-base voltage	Open collector	6	V
I _C	Collector current		6	A
I _B	Base current		3	A
P _C	Collector dissipation	T _C =25℃	50	W
T _j	Junction temperature		150	℃
T _{stg}	Storage temperature		-55~150	℃

Silicon NPN Power Transistors

2SC4512

CHARACTERISTICS

T_j=25°C unless otherwise specified

SYMBOL	PARAMETER	CONDITIONS	MIN	TYP.	MAX	UNIT
V _{(BR)CEO}	Collector-emitter breakdown voltage	I _C =25mA; R _{BE} =∞	80			V
V _{CE(sat)}	Collector-emitter saturation voltage	I _C =2A; I _B =0.2A			0.5	V
I _{CBO}	Collector cut-off current	V _{CB} =120V; I _E =0			10	μA
I _{EBO}	Emitter cut-off current	V _{EB} =6V; I _C =0			10	μA
h _{FE}	DC current gain	I _C =2A; V _{CE} =4V	50			
C _{OB}	Collector output capacitance	f=1MHz; V _{CB} =10V		110		pF
f _T	Transition frequency	I _E =-0.5A; V _{CE} =12V		20		MHz

Switching times

t _{on}	Turn-on time	V _{CC} =30V; I _C =3A I _{B1} =-I _{B2} =0.3A R _L =10Ω		0.16		μs
t _{stg}	Storage time			2.60		μs
t _f	Fall time			0.34		μs

◆ h_{FE} Classifications

O	P	Y
50-100	70-140	90-180

Silicon NPN Power Transistors

2SC4512

PACKAGE OUTLINE

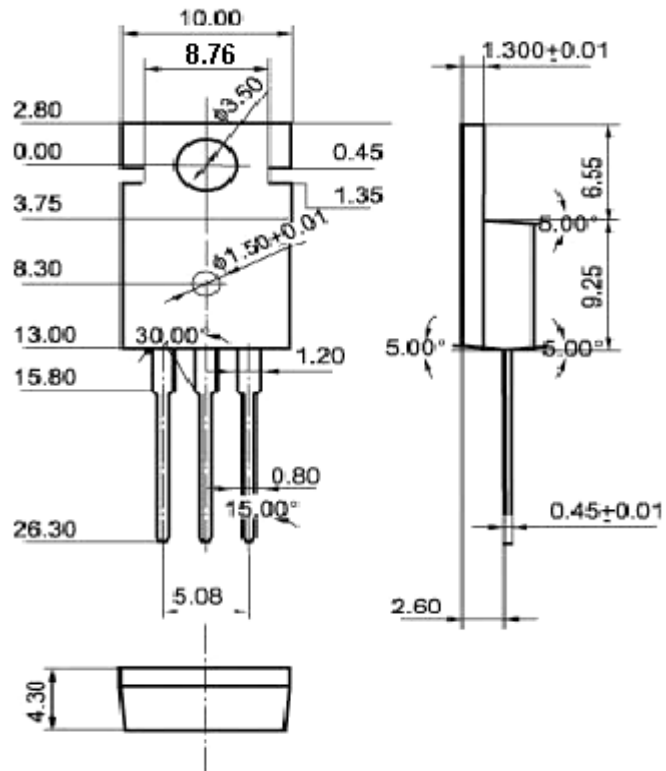

Fig.2 Outline dimensions (unindicated tolerance: ± 0.10 mm)

Silicon NPN Power Transistors

2SC4512

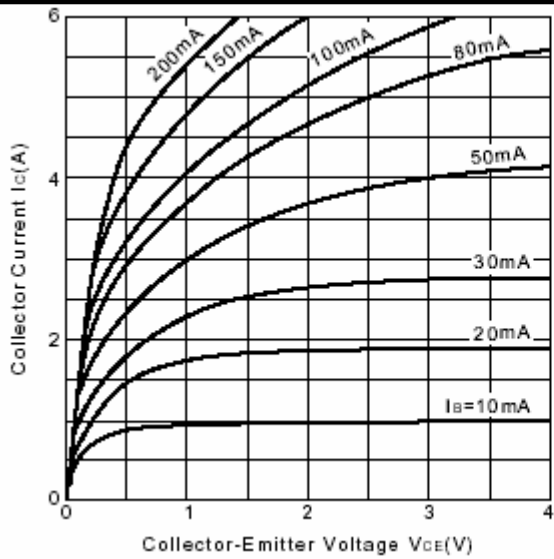

Fig.3 Static Characteristic

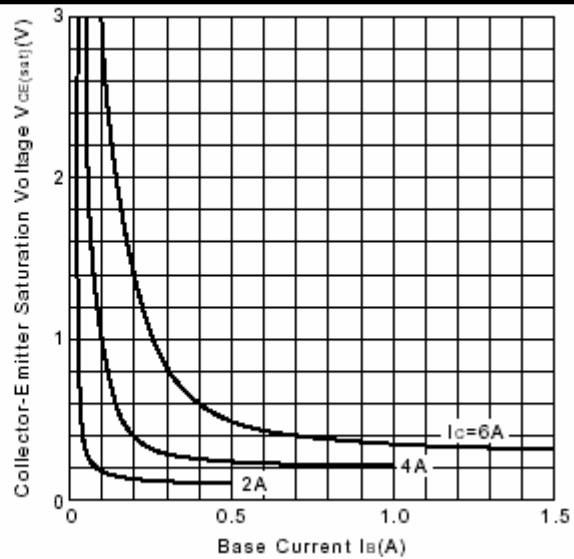

Fig.4 $V_{CE(sat)}-I_B$ Characteristics

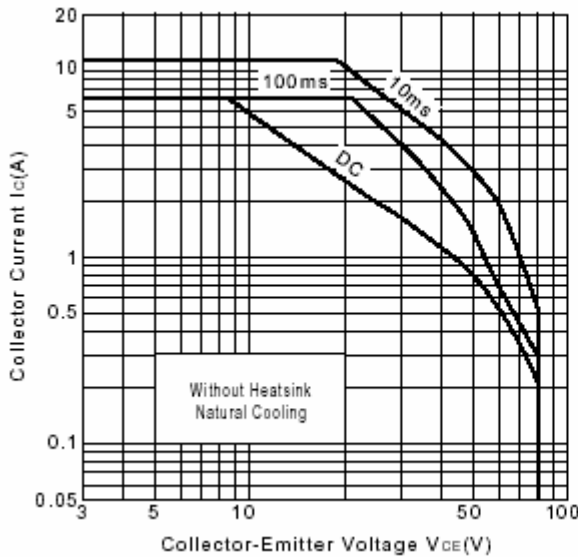

Fig.5 Safe Operating Area

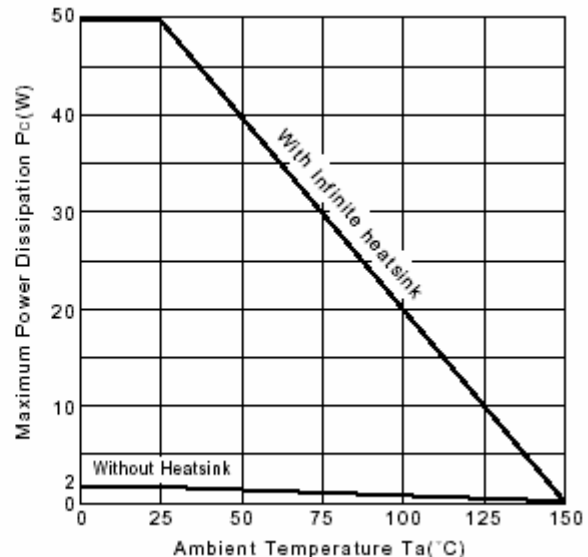

Fig.6 P_c-T_a Derating

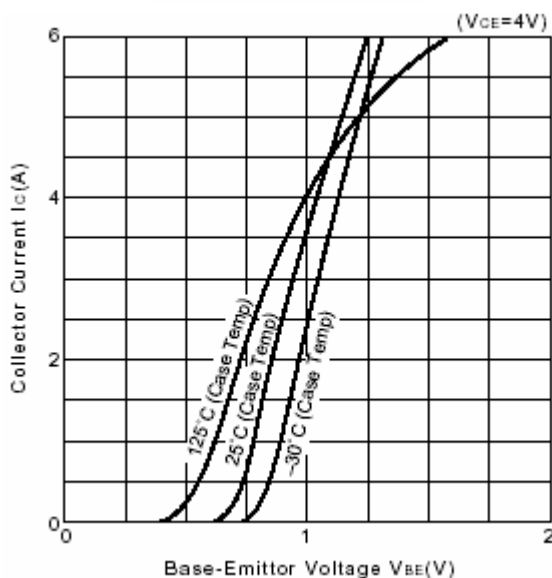

Fig.7 I_C-V_{BE}

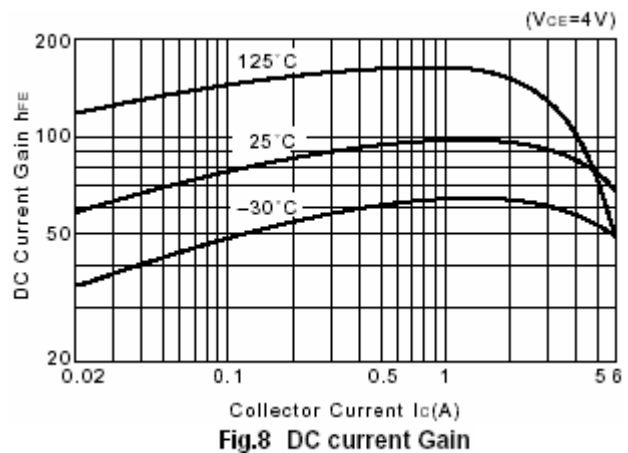

Fig.8 DC current Gain