

Sirenza Microdevices' SGC-6389Z is a high performance SiGe HBT MMIC amplifier utilizing a Darlington configuration with a patented active-bias network. The active bias network provides stable current over temperature and process Beta variations. Designed to run directly from a 5V supply, the SGC-6389Z does not require a dropping resistor as compared to traditional Darlington amplifiers. The SGC-6389Z product is designed for high linearity 5V gain block applications that require small size and minimal external components. It is internally matched to 50 ohms.

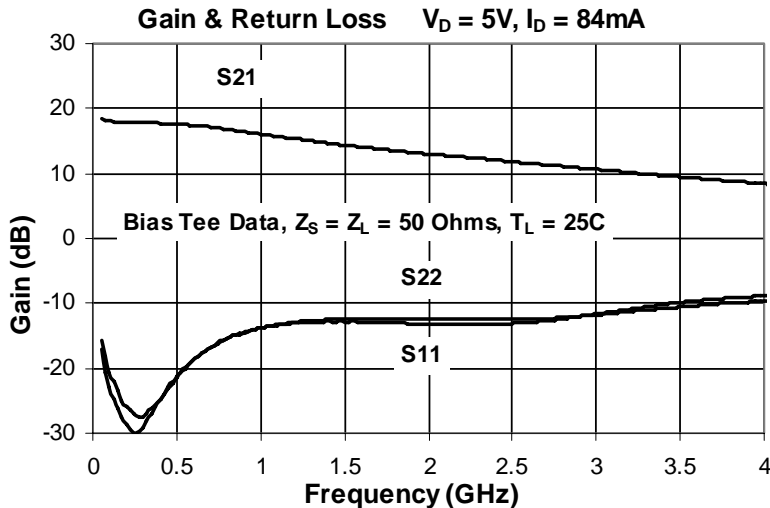

## SGC-6389Z

### 50-4000 MHz Active Bias Silicon Germanium Cascadable Gain Block



#### Product Features

- Single Fixed 5V Supply
- No Dropping Resistor Required
- Patented Self Bias Circuitry
- Gain = 12.8 dBm at 1950 MHz
- P1dB = 18.6 dBm at 1950 MHz
- OIP3 = 34.5 dBm at 1950 MHz
- Robust 1000V ESD, Class 1C HBM

#### Applications

- PA Driver Amplifier
- Cellular, PCS, GSM, UMTS, WCDMA
- IF Amplifier
- Wireless Data, Satellite

Symbol	Parameters	Units	Frequency	Min.	Typ.	Max.
G	Small Signal Gain	dB	850 MHz	14.8	16.3	17.8
			1950 MHz*	11.3	12.8	14.3
			2400 MHz		11.9	
P <sub>1dB</sub>	Output Power at 1dB Compression	dBm	850 MHz		19.5	
			1950 MHz*	17.6	18.6	
			2400 MHz		18.2	
OIP <sub>3</sub>	Output Third Order Intercept Point	dBm	850 MHz		36.0	
			1950 MHz*	32.5	34.5	
			2400 MHz		33.5	
IRL	Input Return Loss	dB	1950 MHz*	9.0	12.5	
ORL	Output Return Loss	dB	1950 MHz*	8.5	11.5	
NF	Noise Figure	dB	1950 MHz*		3.7	4.5
V <sub>D</sub>	Device Operating Voltage	V			5.0	
I <sub>D</sub>	Device Operating Current	mA		74	84	94
R <sub>th, j-l</sub>	Thermal Resistance (junction to lead)	°C/W			60	

**Test Conditions:**  $V_D = 5.0V$   $I_D = 84mA$   $T_L = 25^\circ\text{C}$  OIP3 Tone Spacing = 1MHz, Pout per tone = 0 dBm

Bias Tee Data  $Z_S = Z_L = 50 \text{ Ohms}$  \* Test results at 1950 MHz measured with Application Circuit

The information provided herein is believed to be reliable at press time. Sirenza Microdevices assumes no responsibility for inaccuracies or omissions. Sirenza Microdevices assumes no responsibility for the use of this information, and all such information shall be entirely at the user's own risk. Prices and specifications are subject to change without notice. No patent rights or licenses to any of the circuits described herein are implied or granted to any third party. Sirenza Microdevices does not authorize or warrant any Sirenza Microdevices product for use in life-support devices and/or systems. Copyright 2007 Sirenza Microdevices, Inc.. All worldwide rights reserved.

**Typical RF Performance at Key Operating Frequencies (Bias Tee Data)**

Symbol	Parameter	Unit	Frequency (MHz)						
			50	100	500	850	1950*	2400	3500
G	Small Signal Gain	dB	18.4	18.0	17.6	16.3	12.8	11.9	9.4
OIP <sub>3</sub>	Output Third Order Intercept Point	dBm	36.0	36.5	35.5	36.0	34.5	33.5	30.5
P <sub>1dB</sub>	Output Power at 1dB Compression	dBm	20.7	20.4	19.9	19.5	18.6	18.2	16.5
IRL	Input Return Loss	dB	17.5	23.0	21.5	15.5	12.5	12.0	10.5
ORL	Output Return Loss	dB	15.5	21.0	22.0	15.5	11.5	12.0	10.0
S <sub>12</sub>	Reverse Isolation	dB	20.5	20.0	21.0	21.5	19.5	19.0	18.5
NF	Noise Figure	dB	2.8	2.6	2.9	3.3	3.7	4.0	4.7

**Test Conditions:** V<sub>D</sub> = 5V I<sub>D</sub> = 84mA OIP<sub>3</sub> Tone Spacing = 1MHz, P<sub>out</sub> per tone = 0 dBm  
T<sub>L</sub> = 25°C Z<sub>S</sub> = Z<sub>L</sub> = 50 Ohms \* Test results at 1950 MHz measured with Application Circuit

**Typical Performance with Bias Tees, V<sub>D</sub> = 5V, I<sub>D</sub> = 84mA**

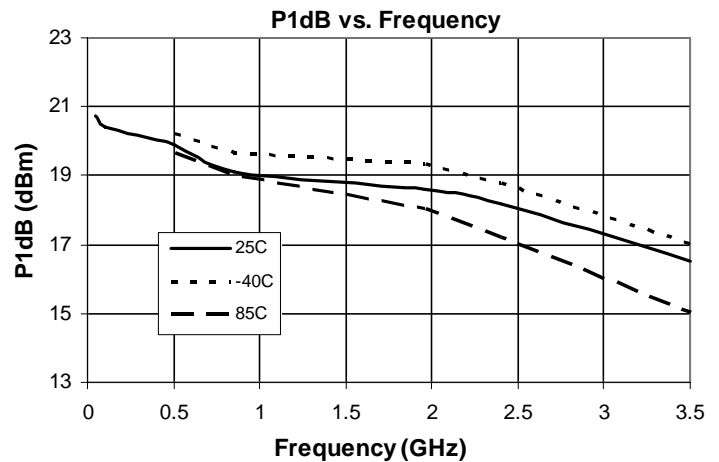
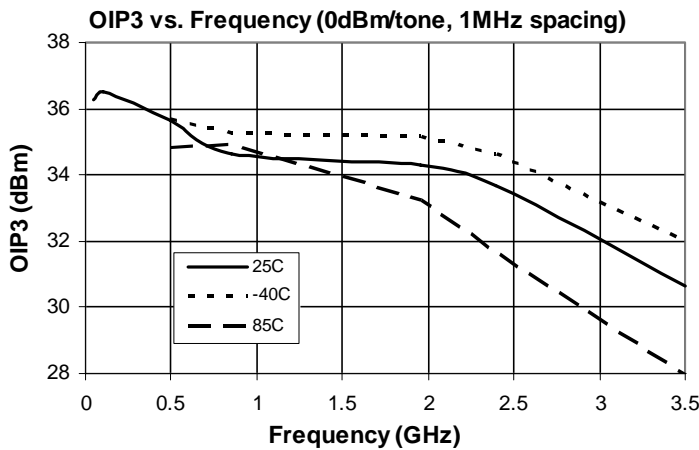

**Absolute Maximum Ratings**

Parameter	Absolute Limit
Max Device Current (I <sub>CE</sub> )	120 mA
Max Device Voltage (V <sub>CE</sub> )	6.5 V
Max. RF Input Power* (See Note)	+18 dBm
Max. Junction Temp. (T <sub>J</sub> )	+150°C
Operating Temp. Range (T <sub>L</sub> )	-40°C to +85°C
Max. Storage Temp.	+150°C

\*Note: Load condition, Z<sub>L</sub> = 50 Ohms

Operation of this device beyond any one of these limits may cause permanent damage. For reliable continuous operation, the device voltage and current must not exceed the maximum operating values specified in the table on page one.

Bias Conditions should also satisfy the following expression:

$$I_D V_D < (T_J - T_L) / R_{TH}, |I| \quad T_L = T_{LEAD}$$

**Reliability & Qualification Information**

Parameter	Rating
ESD Rating - Human Body Model (HBM)	Class 1C
Moisture Sensitivity Level	MSL 1

This product qualification report can be downloaded at [www.sirenza.com](http://www.sirenza.com)



**Caution: ESD sensitive**

Appropriate precautions in handling, packaging and testing devices must be observed.

Typical Performance with Bias Tees,  $V_D = 5V$ ,  $I_D = 84mA$

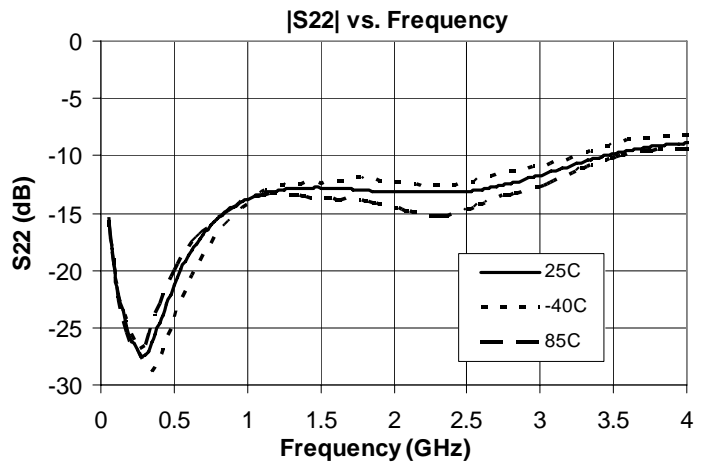
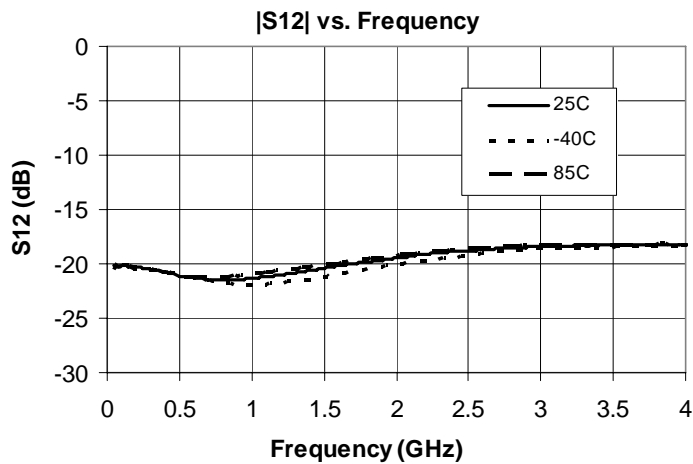
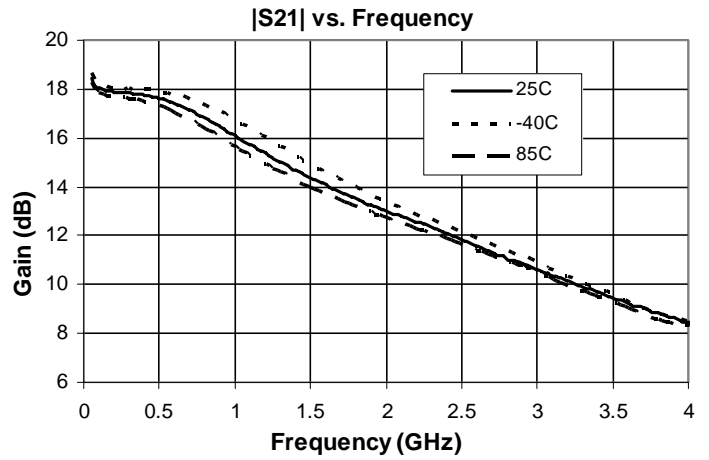
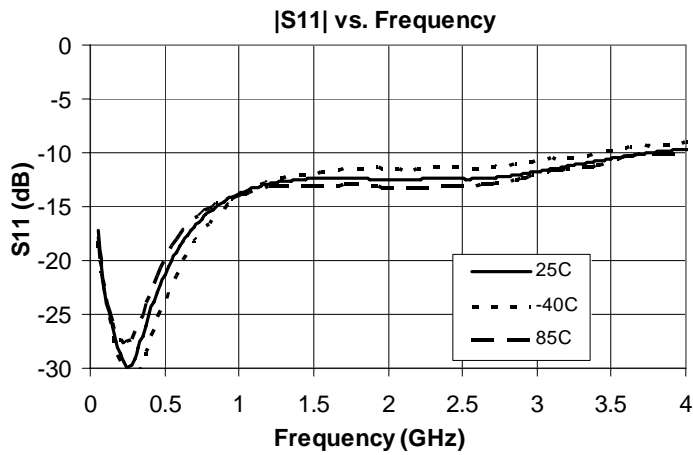
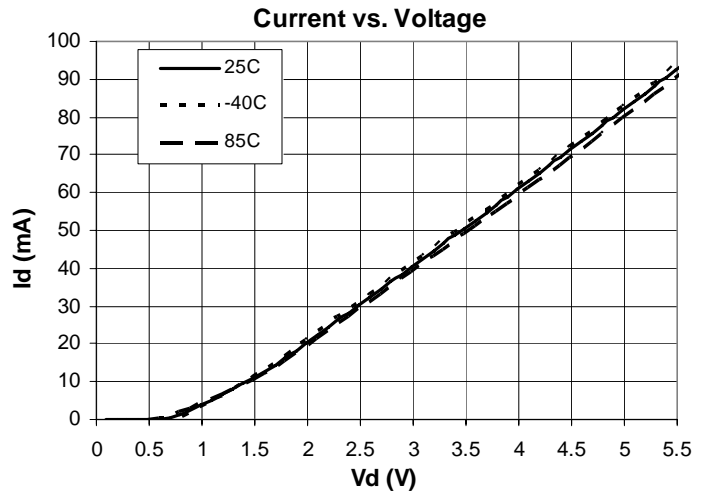
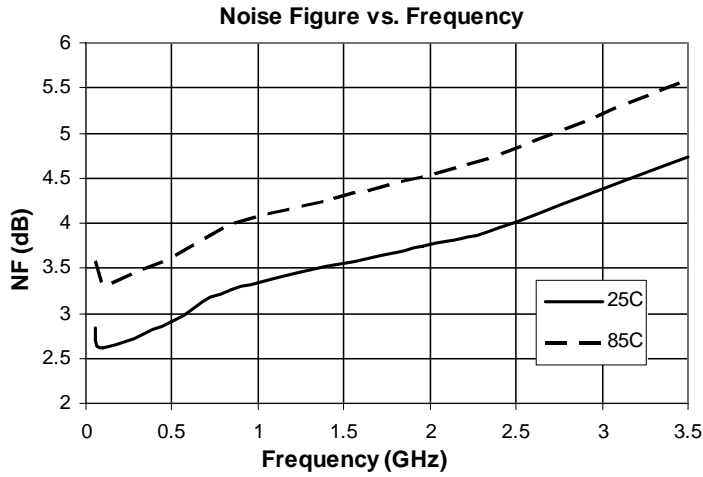

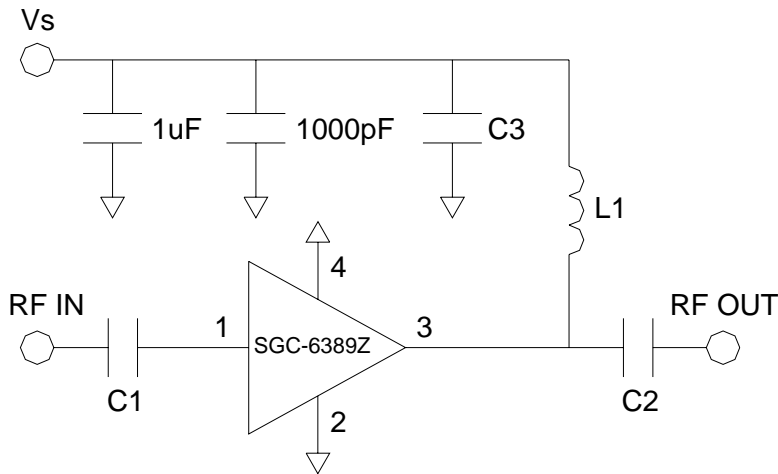

Application Circuit Element Values		
Reference Designator	100-1000MHz	1000-2200MHz
C1	1000pF	6.8pF
C2	100pF	6.8pF
C3	100pF	6.8pF
L1	100nH	39nH

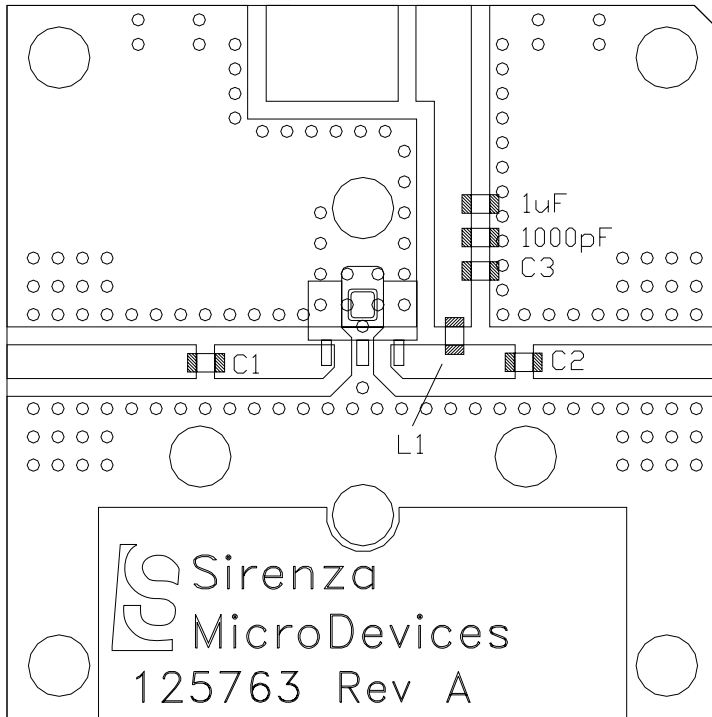

Part Identification Marking & Pinout

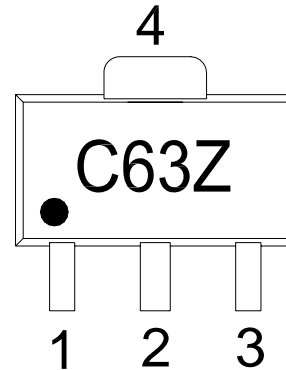

Pin #	Function	Description
1	RF IN	RF input pin. This pin requires the use of an external DC blocking capacitor chosen for the frequency of operation
2,4	GND	Connection to ground. Use via holes as close to the device ground leads as possible to reduce ground inductance and achieve optimum RF performance
3	RF OUT / DCBIAS	RF output and bias pin. This pin requires the use of an external DC blocking capacitor chosen for the frequency of operation.

Part / Evaluation Board Ordering Information			
Part Number	Description	Reel Size	Devices / Reel
SGC-6389Z	Lead Free, RoHs Compliant	13"	3000
SGC-6389Z-EVB1	100-1000 MHz Evaluation Board	N/A	N/A
SGC-6389Z-EVB2	1000-2200 MHz Evaluation Board	N/A	N/A

**SOT-89 PCB Pad Layout**

Dimensions in inches [millimeters]

Notes:

1. Provide a large ground pad area under device pins 2 and 4 with several plated-through holes placed as shown.
2. 1-2 ounce finished copper thickness is recommended.
3. RF I/O lines are 50Ω

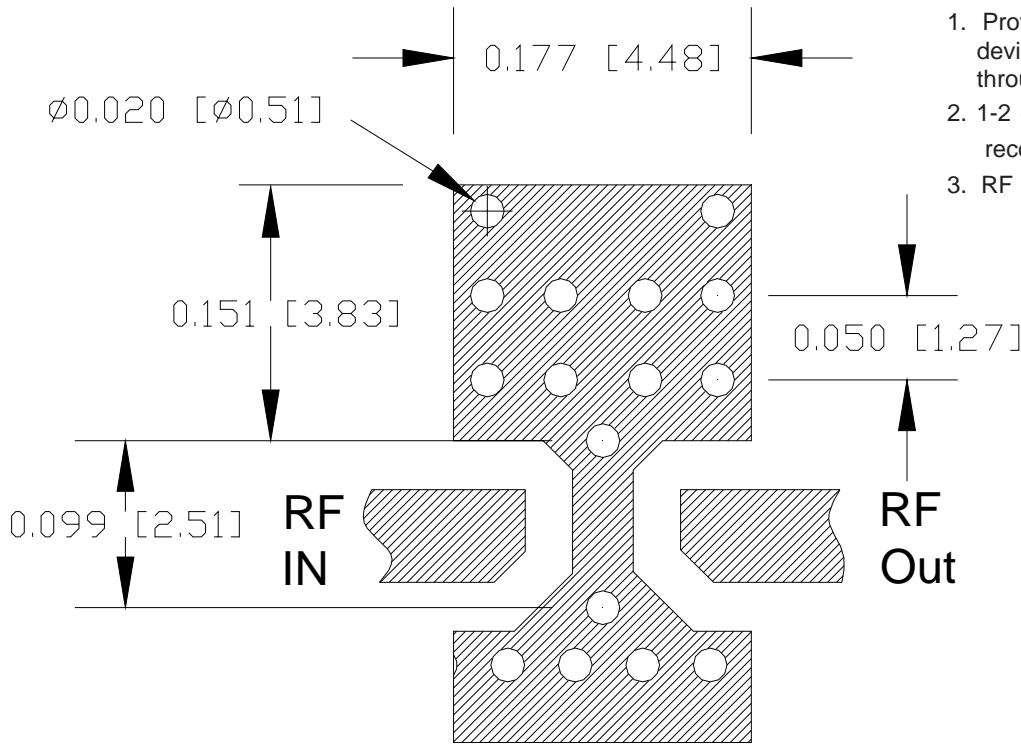

**SOT-89 Nominal Package Dimensions**

Dimensions in inches [millimeters]

A link to the SOT-89 package outline drawing with full dimensions and tolerances may be found on the product web page at [www.sirenza.com](http://www.sirenza.com).

