

## Features

- Small Size and Low Profile
- SOIC-8 Package
- Excellent Amplitude and Phase Balance
- Superior Repeatability
- Typical Insertion Loss: 1.0 dB
- Typical Isolation: 18 dB
- 1 Watt Power Handling

## Description

M/A-COM's DS53-0005 is an IC-based monolithic power divider using M/A-COM's GMIC technology in a low cost SOIC-8 plastic package. This 3-way power divider is ideally suited for applications where small size, low insertion loss, superior phase/amplitude tracking and low cost are required. Typical applications include personal communication systems and other communication applications where size and PCB real estate are at a premium. Available in tape and reel.

The DS53-0005 is fabricated using a passive-integrated circuit process. The process features full-chip passivation for increased performance and reliability.

## Functional Diagram

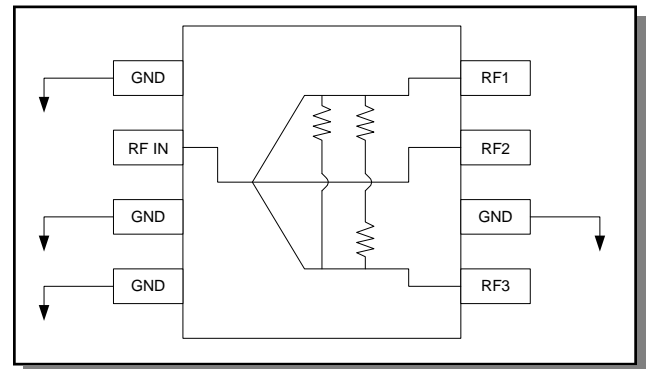

## Pin Configuration

Pin No.	Function	Pin No.	Function
1	GND	5	RF3
2	RF IN	6	GND
3	GND	7	RF2
4	GND	8	RF1

## Ordering Information

Part Number	Package
DS53-0005	Bulk Packaging
DS53-0005-TR	1000 piece reel

Note: Reference Application Note M513 for reel size information.

## Electrical Specifications: $T_A = 25^\circ\text{C}^1$

Parameter	Units	Min	Typ	Max
Insertion Loss above 4.8 dB	dB	—	1.0	1.4
Isolation	dB	12	18	—
VSWR Input	Ratio	—	1.8:1	2.0:1
Amplitude Balance	dB	—	0.3	0.6
Phase Balance	Deg.	—	7	14

1. All specifications apply with a 50-ohm source and load impedance.

## Absolute Maximum Ratings <sup>2,3</sup>

Parameter	Absolute Maximum
Input Power <sup>4</sup>	1W CW
Operating Temperature	-40°C to +85°C
Storage Temperature	-65°C to +150°C

- Exceeding any one or combination of these limits may cause permanent damage to this device.
- M/A-COM does not recommend sustained operation near these survivability limits.
- With internal load dissipation of 0.125W maximum.

## Handling Procedures

Please observe the following precautions to avoid damage:

## Static Sensitivity

GMIC Circuits are sensitive to electrostatic discharge (ESD) and can be damaged by static electricity. Proper ESD control techniques should be used when handling these devices.

## Recommended PIN Configuration

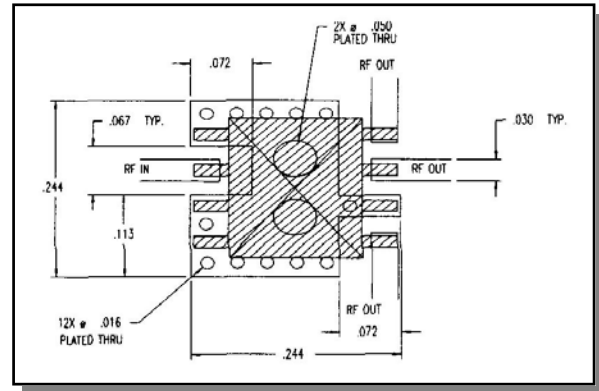

## Typical Performance Curves

**Insertion Loss**  
(Dashed lines show amplitude balance window)

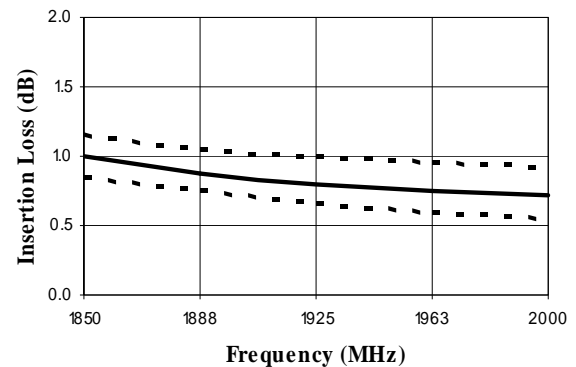

## VSWR

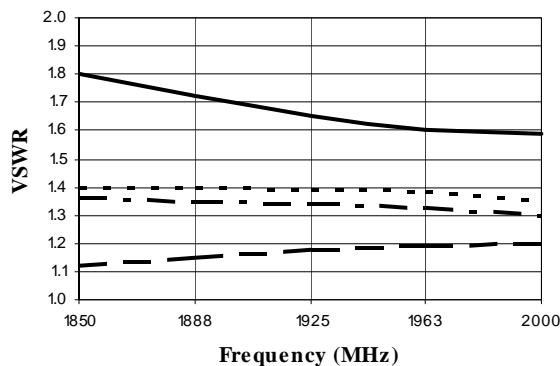

## Isolation

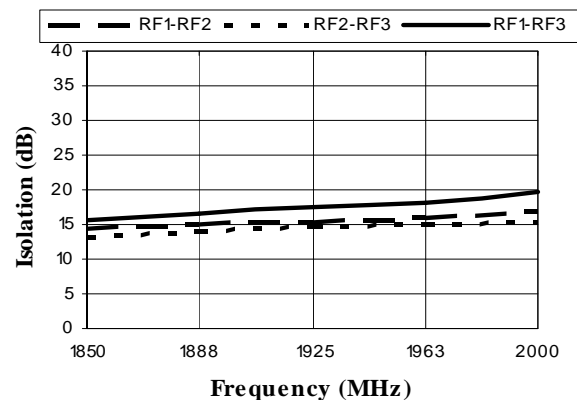

## Typical Performance Curves

### Phase Balance (Relative to RF1)

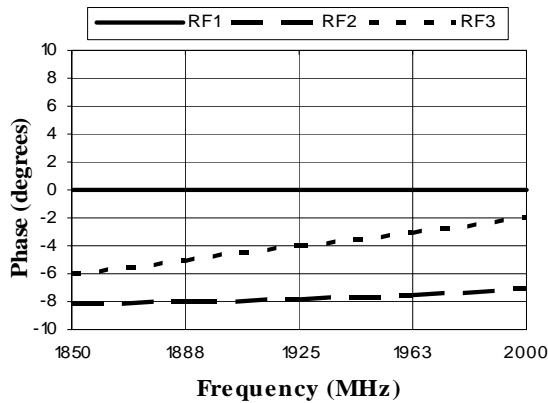

## SOIC-8<sup>†</sup>

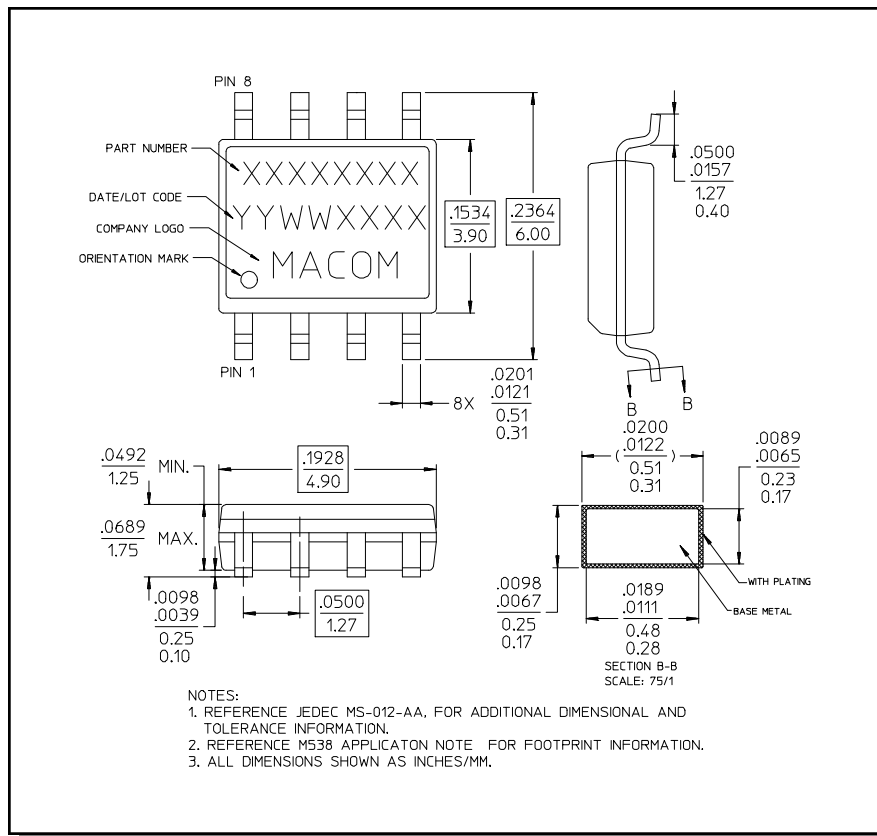

<sup>†</sup> Reference Application Note M538 for lead-free solder reflow recommendations.