

GENERAL DESCRIPTION

This high voltage MOSFET uses an advanced termination scheme to provide enhanced voltage-blocking capability without degrading performance over time. In addition, this advanced MOSFET is designed to withstand high energy in avalanche and commutation modes. The new energy efficient design also offers a drain-to-source diode with a fast recovery time. Designed for high voltage, high speed switching applications in power supplies, converters and PWM motor controls, these devices are particularly well suited for bridge circuits where diode speed and commutating safe operating areas are critical and offer additional and safety margin against unexpected voltage transients.

PIN CONFIGURATION

TO-220/TO-220FP
Top View

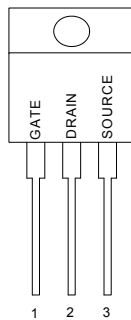

FEATURES

- ◆ Robust High Voltage Termination
- ◆ Avalanche Energy Specified
- ◆ Source-to-Drain Diode Recovery Time Comparable to a Discrete Fast Recovery Diode
- ◆ Diode is Characterized for Use in Bridge Circuits
- ◆ I_{DSS} and $V_{DS(on)}$ Specified at Elevated Temperature

SYMBOL

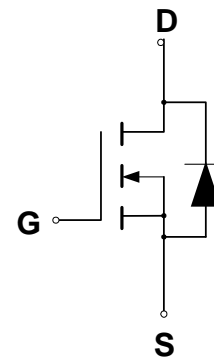

N-Channel MOSFET

ABSOLUTE MAXIMUM RATINGS

Rating	Symbol	Value	Unit
Drain to Current – Continuous	I_D	8.0	A
– Pulsed	I_{DM}	24	
Gate-to-Source Voltage – Continue	V_{GS}	±30	V
– Non-repetitive	V_{GSM}	±40	V
Total Power Dissipation	$P_{D(Max)}$		W
TO-220		83	
TO-220FP		30	
Operating and Storage Temperature Range	T_J, T_{STG}	-55 to 150	°C
Single Pulse Drain-to-Source Avalanche Energy – $T_J = 25^\circ\text{C}$ ($V_{DD} = 100\text{V}, V_{GS} = 10\text{V}, I_L = 8\text{A}, L = 10\text{mH}, R_G = 25\Omega$)	E_{AS}	320	mJ
Thermal Resistance – Junction to Case	θ_{JC}	1.0	°C/W
– Junction to Ambient	θ_{JA}	62.5	
Maximum Lead Temperature for Soldering Purposes, 1/8" from case for 10 seconds	T_L	260	°C

ORDERING INFORMATION

Part Number	Package
CMT08N50GN220*	TO-220
CMT08N50GN220FP*	TO-220 Full Package
CMT08N50XN220*	TO-220
CMT08N50XN220FP*	TO-220 Full Package

*Note : G : Suffix for PB Free Product
 X : Suffix for Halogen Free and PB Free Product

ELECTRICAL CHARACTERISTICS

Unless otherwise specified, $T_J = 25^\circ\text{C}$.

Characteristic		Symbol	CMT08N50			Units
			Min	Typ	Max	
Drain-Source Breakdown Voltage ($V_{GS} = 0\text{ V}$, $I_D = 250\ \mu\text{A}$)		$V_{(BR)DSS}$	500			V
Drain-Source Leakage Current ($V_{DS} = 500\text{ V}$, $V_{GS} = 0\text{ V}$) ($V_{DS} = 400\text{ V}$, $V_{GS} = 0\text{ V}$, $T_J = 125^\circ\text{C}$)		I_{DSS}			1 3	μA
Gate-Source Leakage Current-Forward ($V_{gsf} = 30\text{ V}$, $V_{DS} = 0\text{ V}$)		I_{GSSF}			100	nA
Gate-Source Leakage Current-Reverse ($V_{gsr} = -30\text{ V}$, $V_{DS} = 0\text{ V}$)		I_{GSSR}			100	nA
Gate Threshold Voltage ($V_{DS} = V_{GS}$, $I_D = 250\ \mu\text{A}$)		$V_{GS(th)}$	2.0		4.0	V
Static Drain-Source On-Resistance ($V_{GS} = 10\text{ V}$, $I_D = 4.0\text{A}$) *		$R_{DS(on)}$			0.7	Ω
Drain-Source On-Voltage ($V_{GS} = 10\text{ V}$) ($I_D = 8.0\text{ A}$)		$V_{DS(on)}$		5.0	7.2	V
Forward Transconductance ($V_{DS} = 50\text{ V}$, $I_D = 4.0\text{A}$) *		g_{FS}	4.9			mmhos
Input Capacitance	$(V_{DS} = 25\text{ V}$, $V_{GS} = 0\text{ V}$, $f = 1.0\text{ MHz}$)	C_{iss}		1450		pF
Output Capacitance		C_{oss}		190		pF
Reverse Transfer Capacitance		C_{rss}		45.4		pF
Turn-On Delay Time	$(R_{Go} + C17n = 9.1\Omega)$ *	$t_{d(on)}$		15		ns
Rise Time		t_r		33		ns
Turn-Off Delay Time		$t_{d(off)}$		40		ns
Fall Time		t_f		32		ns
Total Gate Charge	$(V_{DS} = 400\text{ V}$, $I_D = 8.0\text{ A}$, $V_{GS} = 10\text{ V})^*$	Q_g		40		nC
Gate-Source Charge		Q_{gs}		8.0		nC
Gate-Drain Charge		Q_{gd}		17		nC
Internal Drain Inductance (Measured from the drain lead 0.25" from package to center of die)		L_D		4.5		nH
Internal Drain Inductance (Measured from the source lead 0.25" from package to source bond pad)		L_S		7.5		nH
SOURCE-DRAIN DIODE CHARACTERISTICS						
Forward On-Voltage(1)	$(I_S = 8.0\text{ A}$, $V_{GS} = 0\text{ V}$, $d_i/d_t = 100\text{A}/\mu\text{s}$)	V_{SD}			1.5	V
Forward Turn-On Time		t_{on}		35		ns
Reverse Recovery Time		t_{rr}		75		ns

* Pulse Test: Pulse Width $\leq 300\mu\text{s}$, Duty Cycle $\leq 2\%$

** Negligible, Dominated by circuit inductance

TYPICAL ELECTRICAL CHARACTERISTICS

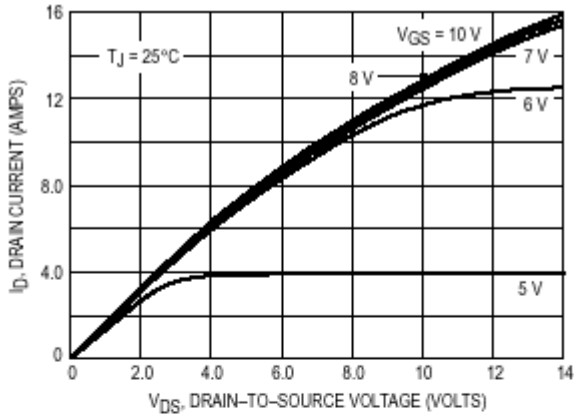

Figure 1. On-Region Characteristics

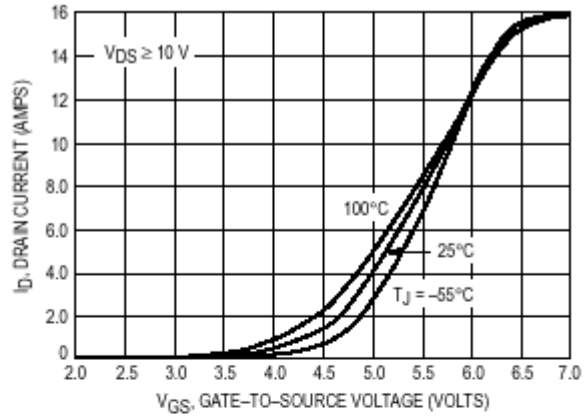

Figure 2. Transfer Characteristics

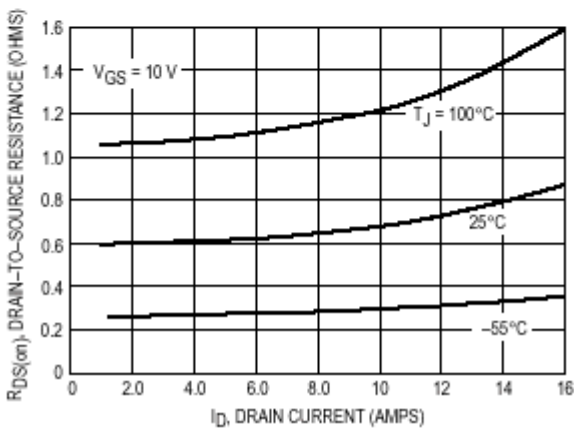

Figure 3. On-Resistance versus Drain Current and Temperature

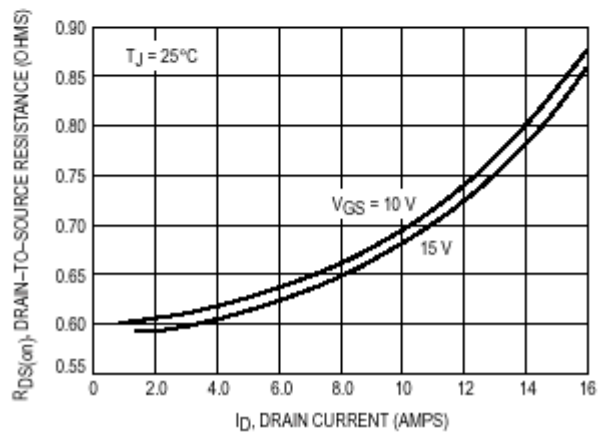

Figure 4. On-Resistance versus Drain Current and Gate Voltage

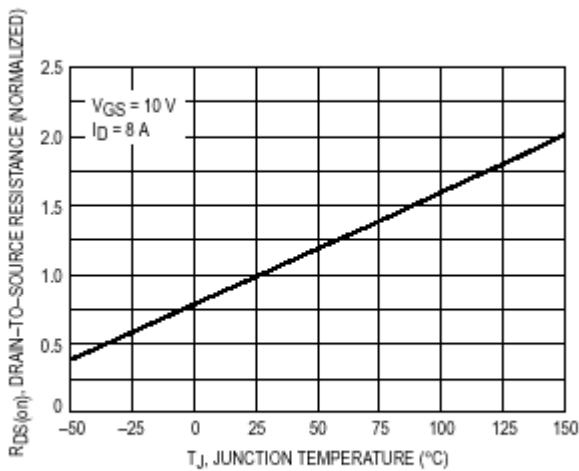

Figure 5. On-Resistance Variation with Temperature

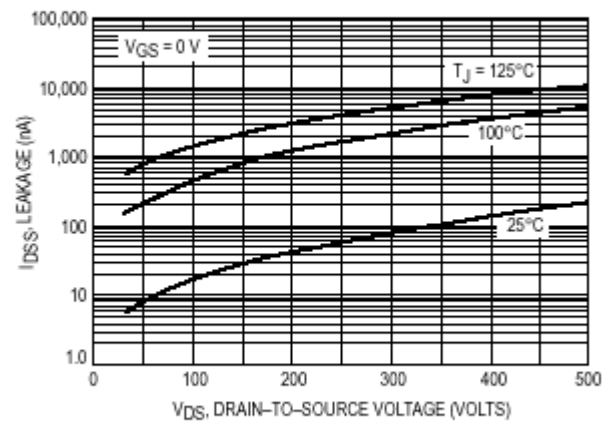

Figure 6. Drain-to-Source Leakage Current versus Voltage

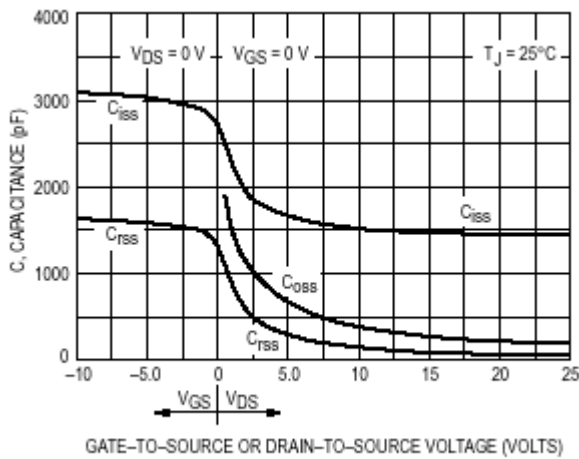

Figure 7. Capacitance Variation

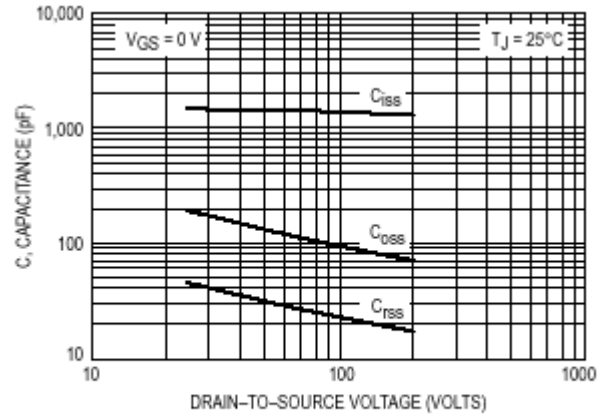

Figure 8. High Voltage Capacitance Variation

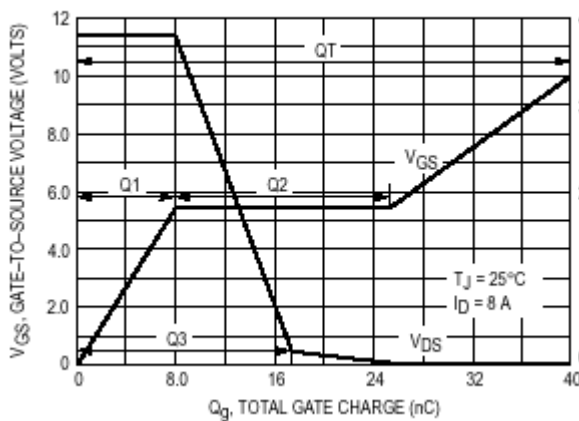

Figure 9. Gate-to-Source and Drain-to-Source Voltage versus Total Charge

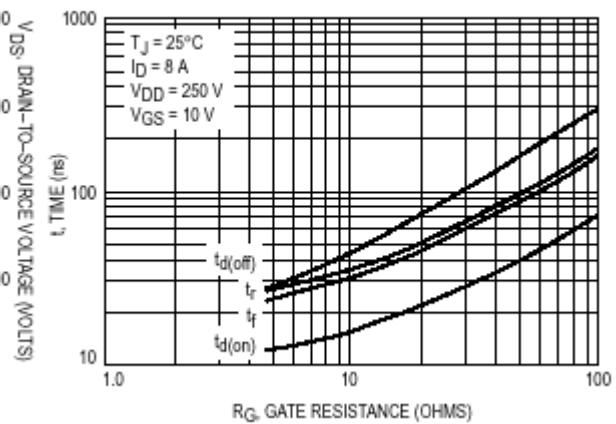

Figure 10. Resistive Switching Time Variation versus Gate Resistance

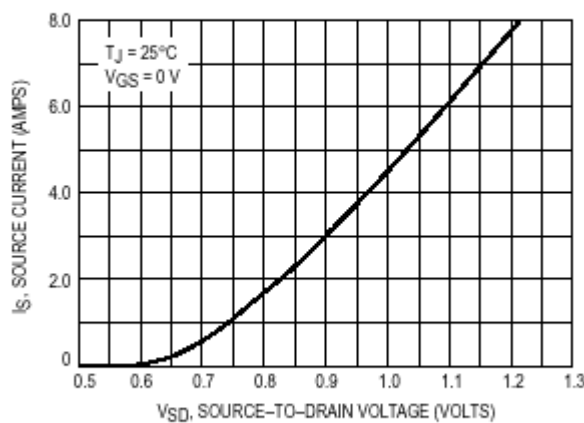

Figure 11. Diode Forward Voltage versus Current

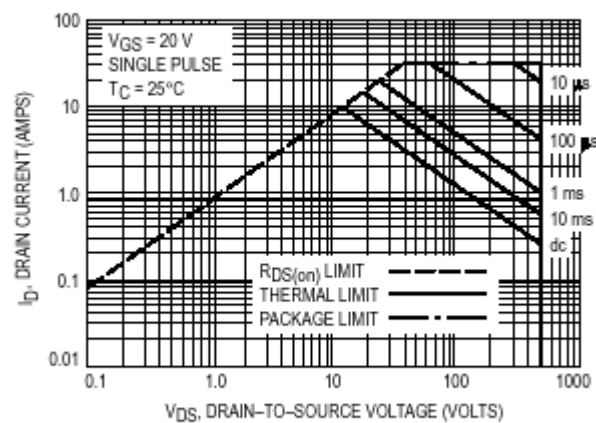

Figure 12. Maximum Rated Forward Biased Safe Operating Area

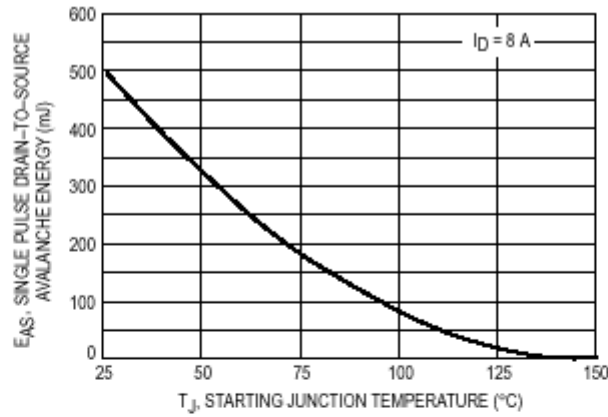

Figure 13. Maximum Avalanche Energy versus Starting Junction Temperature

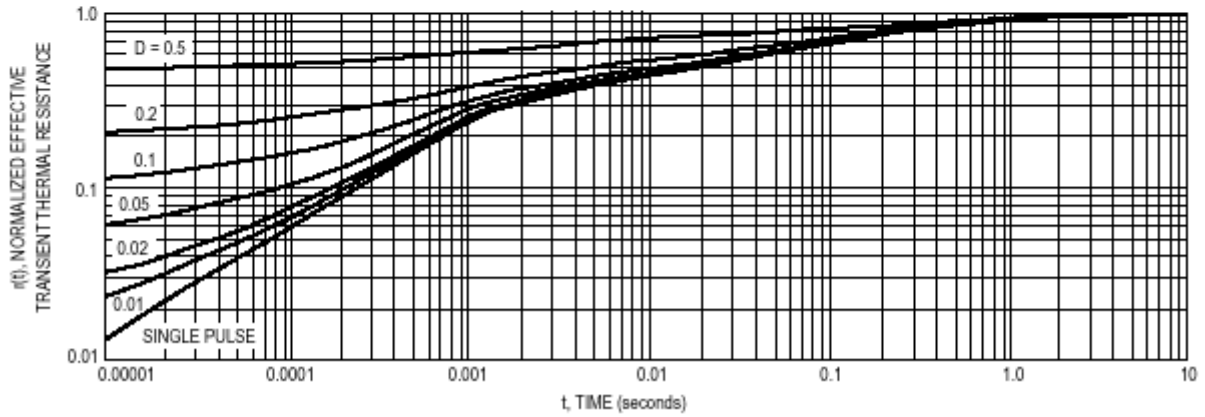
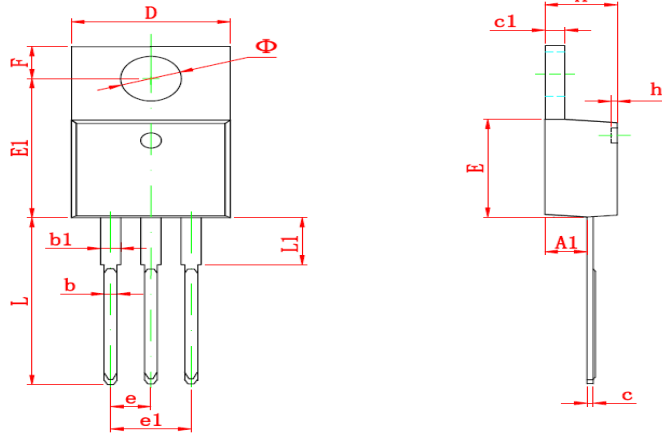

Figure 14. Thermal Response

PACKAGE DIMENSION

TO-220



Symbol	Dimensions In Millimeters		Dimensions In Inches	
	Min	Max	Min	Max
A	4.470	4.670	0.176	0.184
A1	2.520	2.820	0.099	0.111
b	0.710	0.910	0.028	0.036
b1	1.170	1.370	0.046	0.054
c	0.310	0.530	0.012	0.021
c1	1.170	1.370	0.046	0.054
D	10.010	10.310	0.394	0.406
E	8.500	8.900	0.335	0.350
E1	12.060	12.460	0.475	0.491
e	2.540 TYP		0.100 TYP	
e1	4.980	5.180	0.196	0.204
F	2.590	2.890	0.102	0.114
h	0.000	0.300	0.000	0.012
L	13.400	13.800	0.528	0.543
L1	3.560	3.960	0.140	0.156
Φ	3.735	3.935	0.147	0.155

TO-220FP

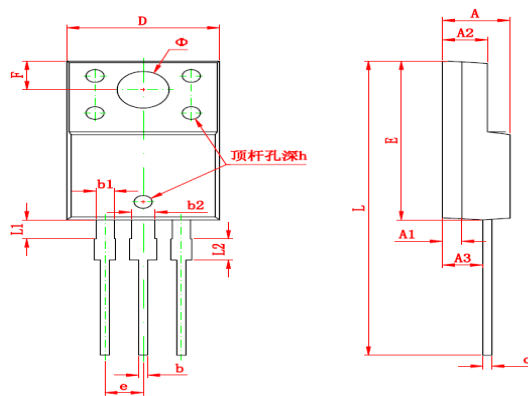

Symbol	Dimensions In Millimeters		Dimensions In Inches	
	Min	Max	Min	Max
A	4.300	4.700	0.169	0.185
A1	1.300 REF		0.051 REF	
A2	2.800	3.200	0.110	0.126
A3	2.500	2.900	0.098	0.114
b	0.500	0.750	0.020	0.030
b1	1.100	1.350	0.043	0.053
b2	1.500	1.750	0.059	0.069
c	0.500	0.750	0.020	0.030
D	9.960	10.360	0.392	0.408
E	14.800	15.200	0.583	0.598
e	2.540 TYP		0.100 TYP	
F	2.700 REF		0.106 REF	
Φ	3.500 REF		0.138 REF	
h	0.000	0.300	0.000	0.012
L	28.000	28.400	1.102	1.118
L1	1.700	1.900	0.067	0.075
L2	1.900	2.100	0.075	0.083

IMPORTANT NOTICE

Champion Microelectronic Corporation (CMC) reserves the right to make changes to its products or to discontinue any integrated circuit product or service without notice, and advises its customers to obtain the latest version of relevant information to verify, before placing orders, that the information being relied on is current.

A few applications using integrated circuit products may involve potential risks of death, personal injury, or severe property or environmental damage. CMC integrated circuit products are not designed, intended, authorized, or warranted to be suitable for use in life-support applications, devices or systems or other critical applications. Use of CMC products in such applications is understood to be fully at the risk of the customer. In order to minimize risks associated with the customer's applications, the customer should provide adequate design and operating safeguards.

HsinChu Headquarter

5F, No. 11, Park Avenue II,
Science-Based Industrial Park,
HsinChu City, Taiwan
TEL: +886-3-567 9979
FAX: +886-3-567 9909

Sales & Marketing

21F., No. 96, Sec. 1, Sintai 5th Rd., Sijhih City,
Taipei County 22102,
Taiwan, R.O.C.
TEL: +886-2-2696 3558
FAX: +886-2-2696 3559
