

Silicon NPN Power Transistors

2SD1065

DESCRIPTION

- With TO-3PN package
- Complement to type 2SB829
- Wide area of safe operation
- Low collector saturation voltage

APPLICATIONS

- Relay drivers,
- High-speed inverters,
- Converters,
- General high-current switching applications

PINNING

PIN	DESCRIPTION
1	Base
2	Collector;connected to mounting base
3	Emitter

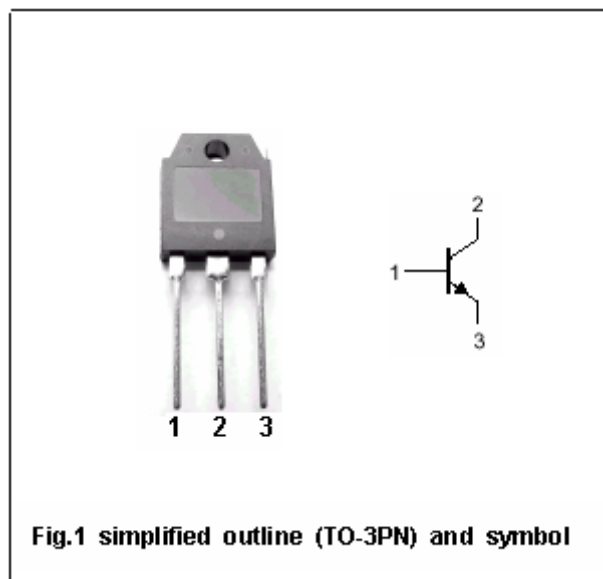
Absolute maximum ratings($T_c=25^\circ\text{C}$)

SYMBOL	PARAMETER	CONDITIONS	VALUE	UNIT
V_{CBO}	Collector-base voltage	Open emitter	60	V
V_{CEO}	Collector-emitter voltage	Open base	50	V
V_{EBO}	Emitter-base voltage	Open collector	6	V
I_C	Collector current (DC)		15	A
I_{CM}	Collector current -peak		20	A
P_C	Collector power dissipation	$T_c=25^\circ\text{C}$	90	W
T_j	Junction temperature		150	$^\circ\text{C}$
T_{stg}	Storage temperature		-55~150	$^\circ\text{C}$

Silicon NPN Power Transistors

2SD1065

CHARACTERISTICS

T_j=25°C unless otherwise specified

SYMBOL	PARAMETER	CONDITIONS	MIN	TYP.	MAX	UNIT
V _{(BR)CEO}	Collector-emitter breakdown voltage	I _C =1mA ; R _{BE} =∞	50			V
V _{(BR)CBO}	Collector-base breakdown voltage	I _C =1mA ; I _E =0	60			V
V _{(BR)EBO}	Emitter-base breakdown voltage	I _E =1mA ; I _C =0	6			V
V _{CEsat}	Collector-emitter saturation voltage	I _C =8A ; I _B =0.4A		0.18	0.4	V
I _{CBO}	Collector cut-off current	V _{CB} =40V ; I _E =0			0.1	mA
I _{EBO}	Emitter cut-off current	V _{EB} =4V ; I _C =0			0.1	mA
h _{FE-1}	DC current gain	I _C =1A ; V _{CE} =2V	70		280	
h _{FE-2}	DC current gain	I _C =8A ; V _{CE} =2V	30			
f _T	Transition frequency	I _C =1A ; V _{CE} =5V		20		MHz

Switching times

t _{on}	Turn-on time	I _C =2.0A ; I _{B1} =-I _{B2} =0.2A V _{CC} =20V ; R _L =10 Ω		0.20		μ s
t _{stg}	Storage time			0.10		μ s
t _f	Fall time			1.00		μ s

◆ h_{FE-1} Classifications

Q	R	S
70-140	100-200	140-280

Silicon NPN Power Transistors

2SD1065

PACKAGE OUTLINE

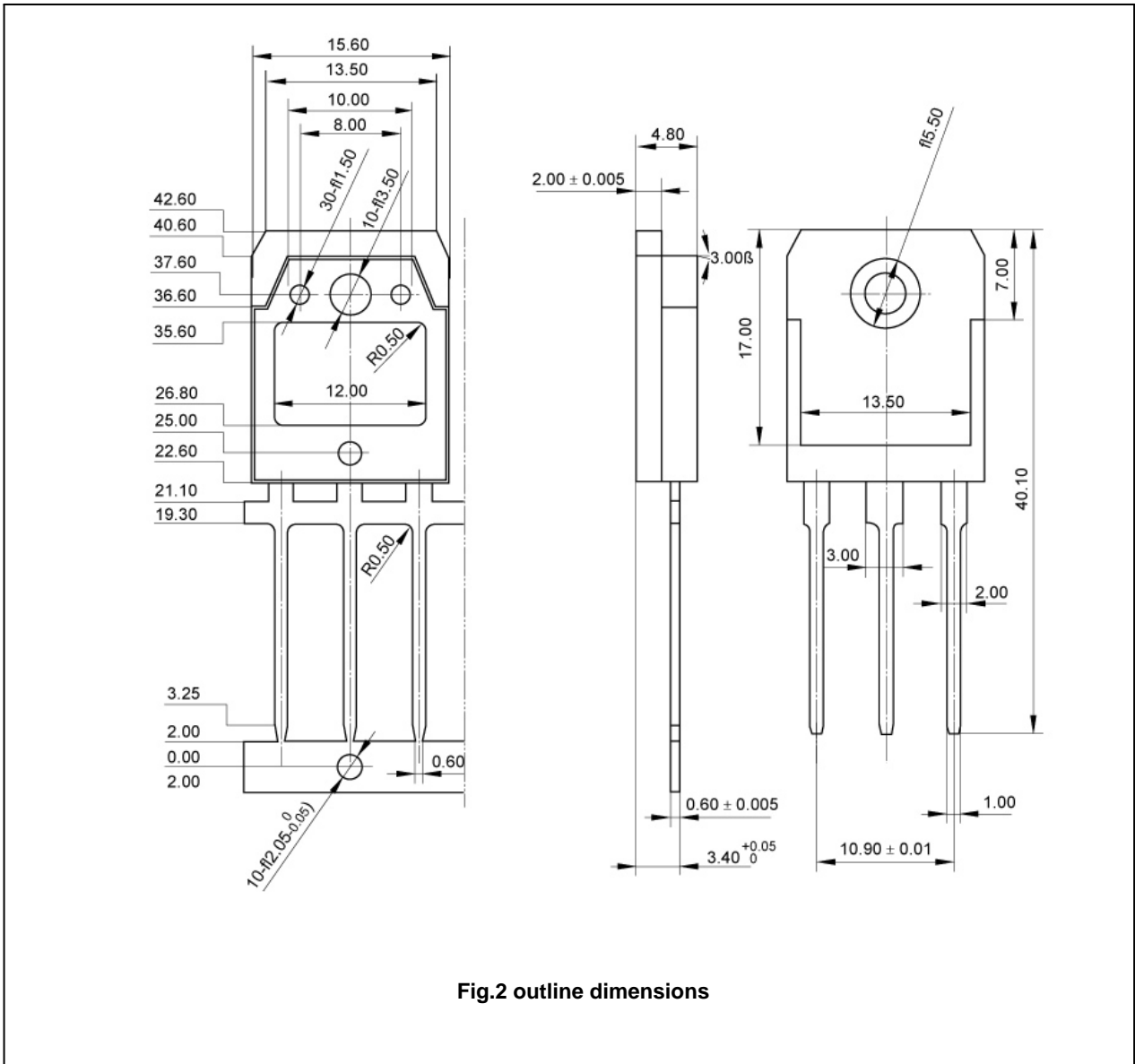

Fig.2 outline dimensions

Silicon NPN Power Transistors

2SD1065

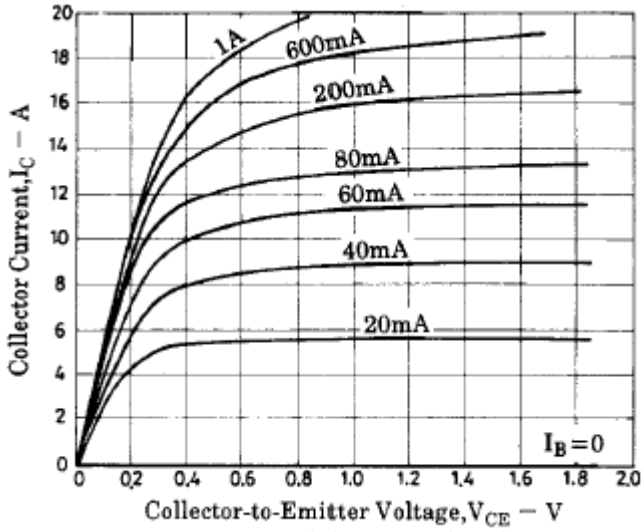

Fig.3 Static Characteristic

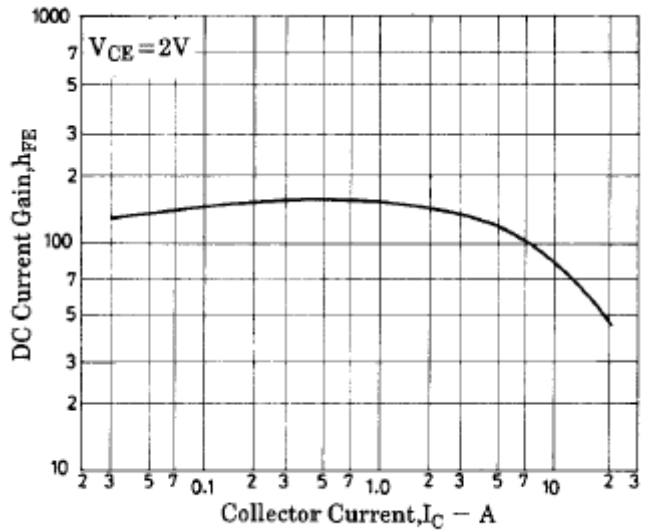

Fig.4 DC current Gain

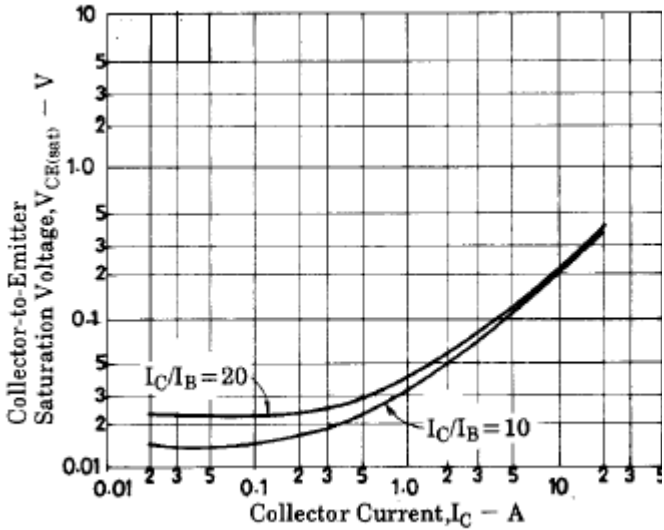

Fig.5 Collector-Emmitter Saturation Voltage

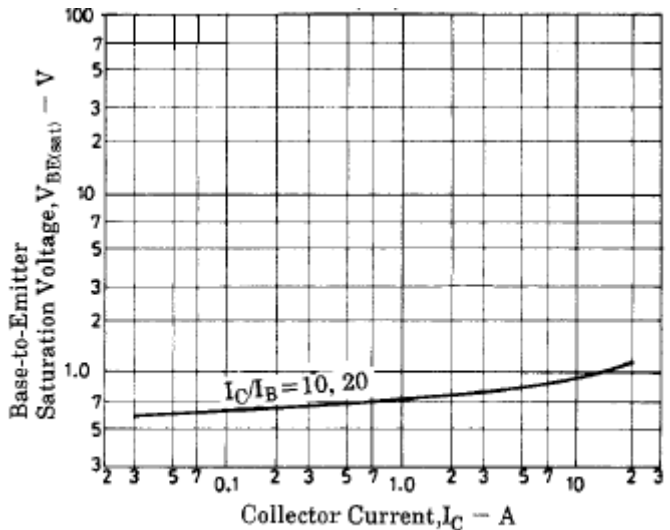

Fig.6 Base-Emmitter Saturation Voltage

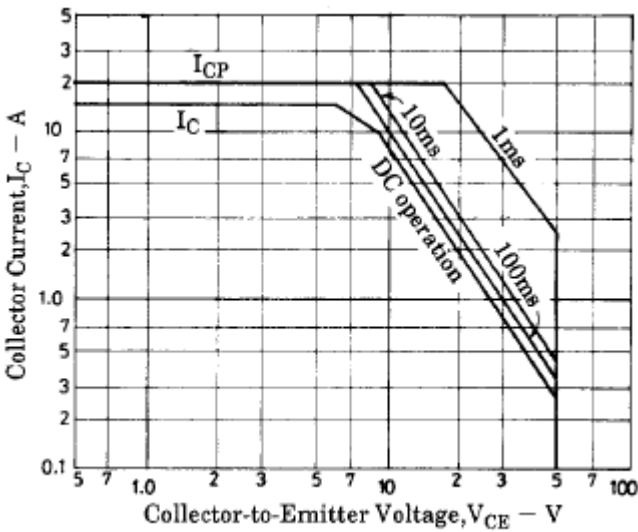

Fig.7 Safe Operating Area