

Silicon PNP Power Transistors

2SA1215

DESCRIPTION

- With MT-200 package
- Complement to type 2SC2921

APPLICATIONS

- Audio and general purpose

PINNING(see Fig.2)

PIN	DESCRIPTION
1	Base
2	Collector;connected to mounting base
3	Emitter

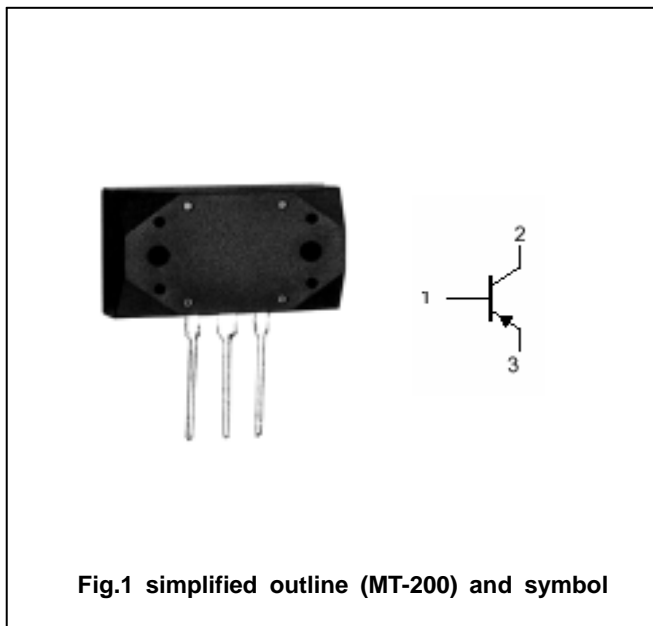

Fig.1 simplified outline (MT-200) and symbol

Absolute maximum ratings(Ta=25)

SYMBOL	PARAMETER	CONDITIONS	VALUE	UNIT
V _{CBO}	Collector-base voltage	Open emitter	-160	V
V _{CEO}	Collector-emitter voltage	Open base	-160	V
V _{EBO}	Emitter-base voltage	Open collector	-5	V
I _C	Collector current		-15	A
I _B	Base current		-4	A
P _C	Collector power dissipation	T _C =25	150	W
T _j	Junction temperature		150	
T _{stg}	Storage temperature		-55~150	

Silicon PNP Power Transistors

2SA1215

CHARACTERISTICS

T_j=25 unless otherwise specified

SYMBOL	PARAMETER	CONDITIONS	MIN	TYP.	MAX	UNIT
V _{CEO}	Collector-emitter breakdown voltage	I _C =-25mA ; I _B =0	-160			V
V _{CEsat}	Collector-emitter saturation voltage	I _C =-5A ; I _B =-0.5A			-2.0	V
I _{CBO}	Collector cut-off current	V _{CB} =-160V ; I _E =0			-100	μ A
I _{EBO}	Emitter cut-off current	V _{EB} =-5V ; I _C =0			-100	μ A
h _{FE}	DC current gain	I _C =-5A ; V _{CE} =-4V	50		180	
C _{ob}	Output capacitance	I _E =0 ; V _{CB} =-10V ; f=1MHz		400		pF
f _T	Transition frequency	I _C =-2A ; V _{CE} =-12V		50		MHz

Switching times

t _{on}	Turn-on time	I _C =-5A ; R _L =12 I _{B1} =-I _{B2} =-0.5A V _{CC} =-60V		0.25		μ s
t _s	Storage time			0.85		μ s
t _f	Fall time			0.20		μ s

◆ h_{FE} classifications

O	P	Y
50-100	70-140	90-180

Silicon PNP Power Transistors

2SA1215

PACKAGE OUTLINE

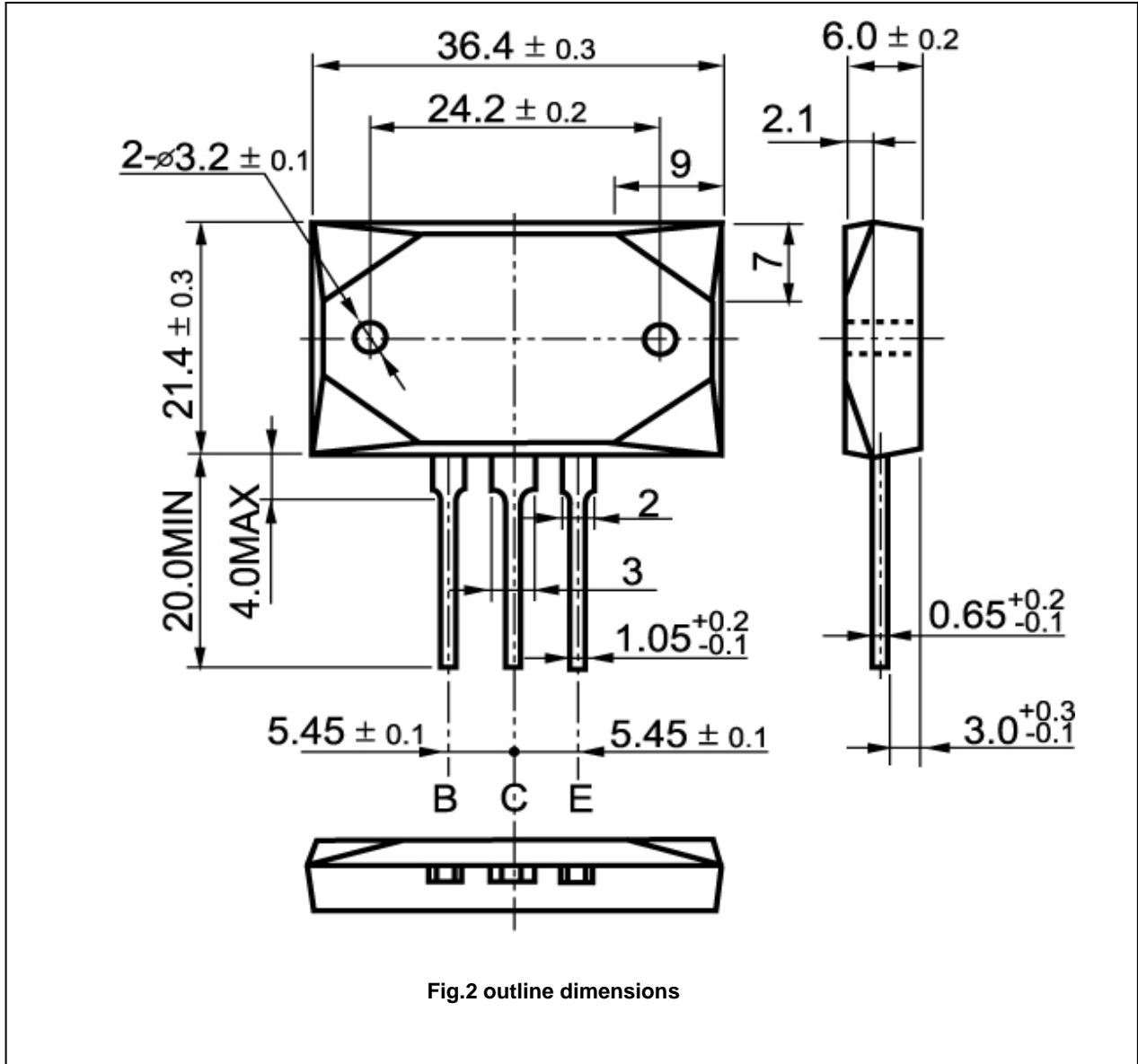

Fig.2 outline dimensions

Silicon PNP Power Transistors

2SA1215

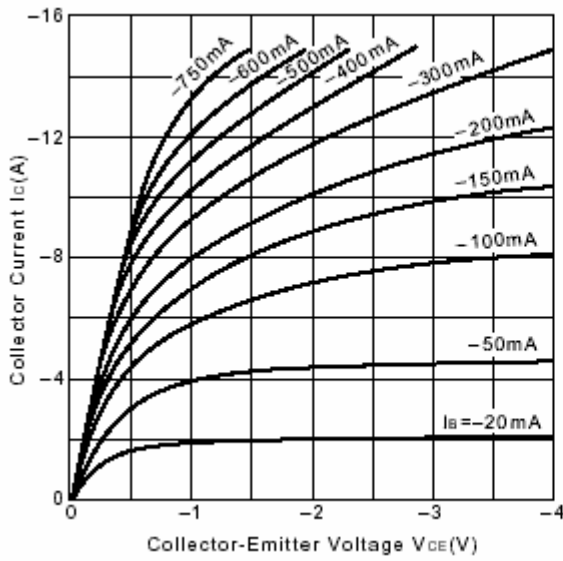

Fig.3 Static Characteristic

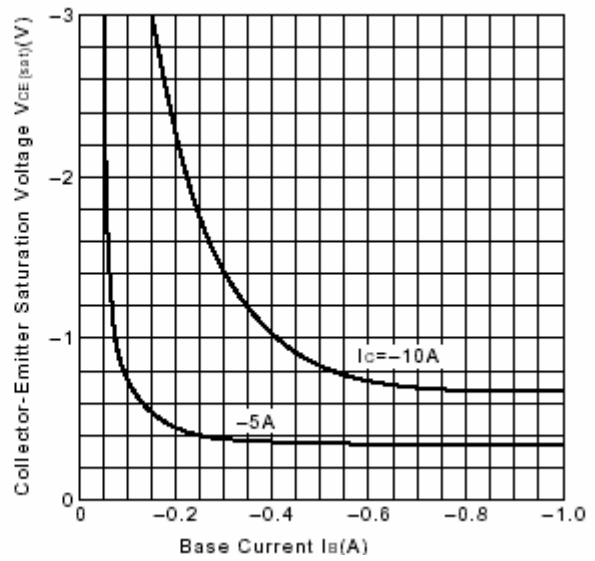

Fig.4 $V_{CE(sat)}$ - I_B Characteristics

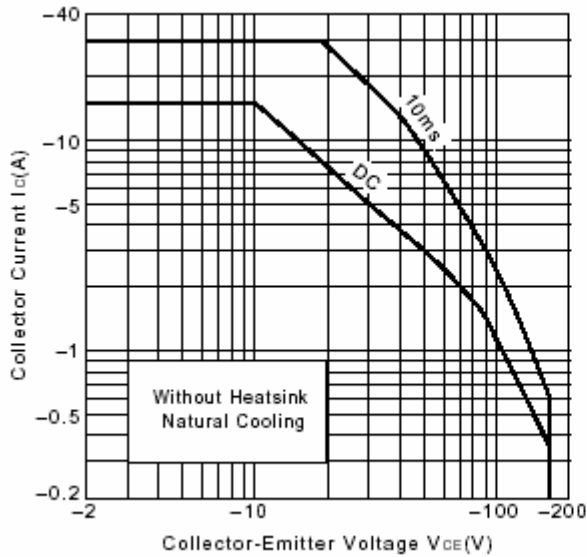

Fig.5 Safe Operating Area

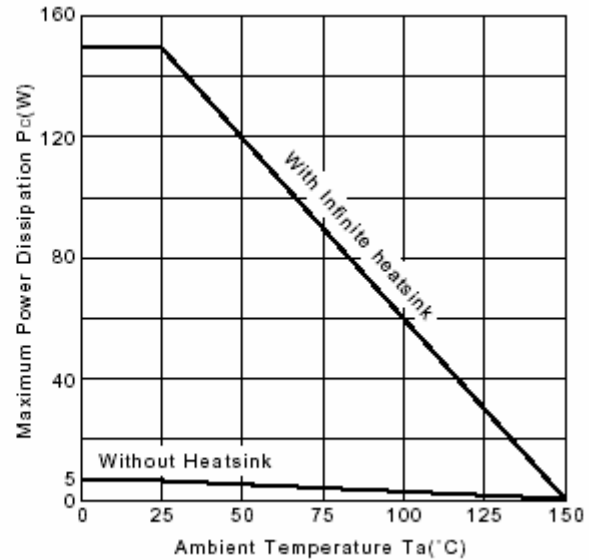

Fig.6 P_c - T_a Derating

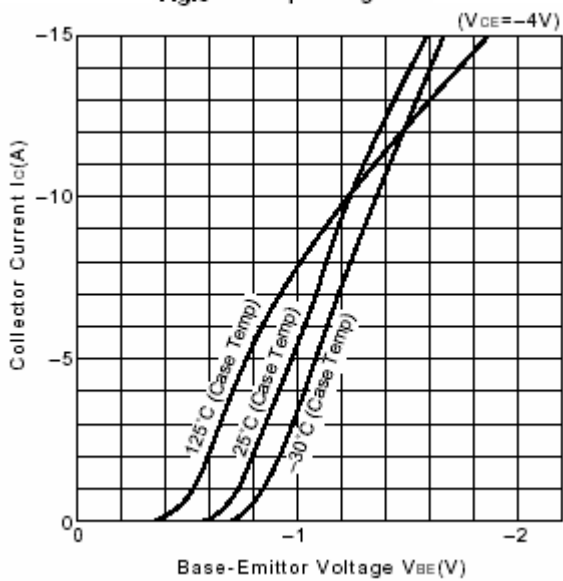

Fig.7 I_C - V_{BE}

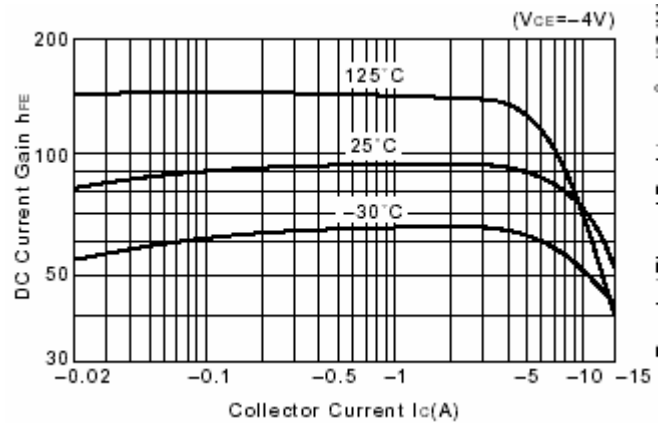

Fig.8 DC current Gain