

1N4727...1N4764

SILICON PLANAR POWER ZENER DIODES

for use in stabilizing and clipping circuits with high power rating. Standard zener voltage tolerance is $\pm 10\%$. Add suffix "A" for $\pm 5\%$ tolerance and suffix "B" for $\pm 2\%$ tolerance. Other tolerances are available upon request.

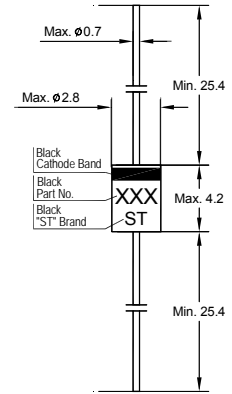

Glass Case DO-41
Dimensions in mm

Absolute Maximum Ratings ($T_a = 25\text{ }^\circ\text{C}$)

Parameter	Symbol	Value	Unit
Power Dissipation	P_{tot}	1 ¹⁾	W
Junction Temperature	T_j	200	$^\circ\text{C}$
Storage Temperature Range	T_s	- 65 to + 200	$^\circ\text{C}$

¹⁾ Valid provided that leads at a distance of 8 mm from case are kept at ambient temperature.

Characteristics at $T_a = 25\text{ }^\circ\text{C}$

Parameter	Symbol	Max.	Unit
Thermal Resistance Junction to Ambient Air	R_{thA}	170 ¹⁾	K/W
Forward Voltage at $I_F = 200\text{ mA}$	V_F	1.2	V

¹⁾ Valid provided that leads at a distance of 8 mm from case are kept at ambient temperature.

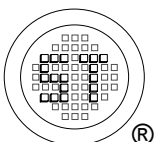

SEMTECH ELECTRONICS LTD.

(Subsidiary of Sino-Tech International Holdings Limited, a company listed on the Hong Kong Stock Exchange, Stock Code: 724)



ISO/TS 16949 : 2002
Certificate No. 05103



ISO 14001:2004
Certificate No. 7116



ISO 9001:2000
Certificate No. 0506088

Dated : 12/06/2007

1N4727...1N4764

Type	Zener Voltage Range ^{3), 5)}		Maximum Zener Impedance ¹⁾			Maximum Reverse Leakage Current		Maximum Surge Current ⁴⁾	Maximum Regulator Current ²⁾
	V _{Znom}	I _{ZT}	r _{ZJT}	r _{ZJK}	at I _{ZK}	I _R	at V _R	at T _a = 25 °C	
	V	mA	Ω	Ω	mA	μA	V	I _{ZSM} (mA)	I _{ZM} (mA)
1N4727	3	83	10	400	1	150	1	1375	275
1N4728	3.3	76	10	400	1	150	1	1375	275
1N4729	3.6	69	10	400	1	100	1	1260	252
1N4730	3.9	64	9	400	1	100	1	1190	234
1N4731	4.3	58	9	400	1	50	1	1070	217
1N4732	4.7	53	8	500	1	10	1	970	193
1N4733	5.1	49	7	550	1	10	1	890	178
1N4734	5.6	45	5	600	1	10	2	810	162
1N4735	6.2	41	2	700	1	10	3	730	146
1N4736	6.8	37	3.5	700	1	10	4	660	133
1N4737	7.5	34	4	700	0.5	10	5	605	121
1N4738	8.2	31	4.5	700	0.5	10	6	550	110
1N4739	9.1	28	5	700	0.5	10	7	500	100
1N4740	10	25	7	700	0.25	10	7.6	454	91
1N4741	11	23	8	700	0.25	5	8.4	414	83
1N4742	12	21	9	700	0.25	5	9.1	380	76
1N4743	13	19	10	700	0.25	5	9.9	344	69
1N4744	15	17	14	700	0.25	5	11.4	304	61
1N4745	16	15.5	16	700	0.25	5	12.2	285	57
1N4746	18	14	20	750	0.25	5	13.7	250	50
1N4747	20	12.5	22	750	0.25	5	15.2	225	45
1N4748	22	11.5	23	750	0.25	5	16.7	205	41
1N4749	24	10.5	25	750	0.25	5	18.2	190	38
1N4750	27	9.5	35	750	0.25	5	20.6	170	34
1N4751	30	8.5	40	1000	0.25	5	22.8	150	30
1N4752	33	7.5	45	1000	0.25	5	25.1	135	27
1N4753	36	7	50	1000	0.25	5	27.4	125	25
1N4754	39	6.5	60	1000	0.25	5	29.7	115	23
1N4755	43	6	70	1500	0.25	5	32.7	110	22
1N4756	47	5.5	80	1500	0.25	5	35.8	95	19
1N4757	51	5	95	1500	0.25	5	38.8	90	18
1N4758	56	4.5	110	2000	0.25	5	42.6	80	16
1N4759	62	4	125	2000	0.25	5	47.1	70	14
1N4760	68	3.7	150	2000	0.25	5	51.7	65	13
1N4761	75	3.3	175	2000	0.25	5	56	60	12
1N4762	82	3	200	3000	0.25	5	62.2	55	11
1N4763	91	2.8	250	3000	0.25	5	69.2	50	10
1N4764	100	2.5	350	3000	0.25	5	76	45	9

¹⁾ The Zener Impedance is derived from the 60 Hz AC voltage which results when an AC current having an RMS value equal to 10% of the Zener Current (I_{ZT} or I_{ZK}) is superimposed on I_{ZT} or I_{ZK}. Zener Impedance is measured at two points to insure a sharp knee on the breakdown curve and to eliminate unstable units.

²⁾ Valid provided that leads at a distance of 8 mm from case are kept at ambient temperature.

³⁾ Measured under thermal equilibrium and DC test conditions.

⁴⁾ The rating listed in the electrical characteristics table is maximum peak, non-repetitive, reverse surge current of 1/2 square wave or equivalent sine wave pulse of 1/120 second duration superimposed on the test current I_{ZT}.

⁵⁾ Tested with pulses tp = 20 ms.

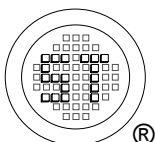

SEMTECH ELECTRONICS LTD.
 (Subsidiary of Sino-Tech International Holdings Limited, a company
 listed on the Hong Kong Stock Exchange, Stock Code: 724)



ISO/TS 16949 : 2002
 Certificate No. 05103



ISO 14001:2004
 Certificate No. 7116



ISO 9001:2000
 Certificate No. 0506088

1N4727...1N4764

Breakdown characteristics

$T_j = \text{constant (pulsed)}$

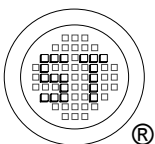
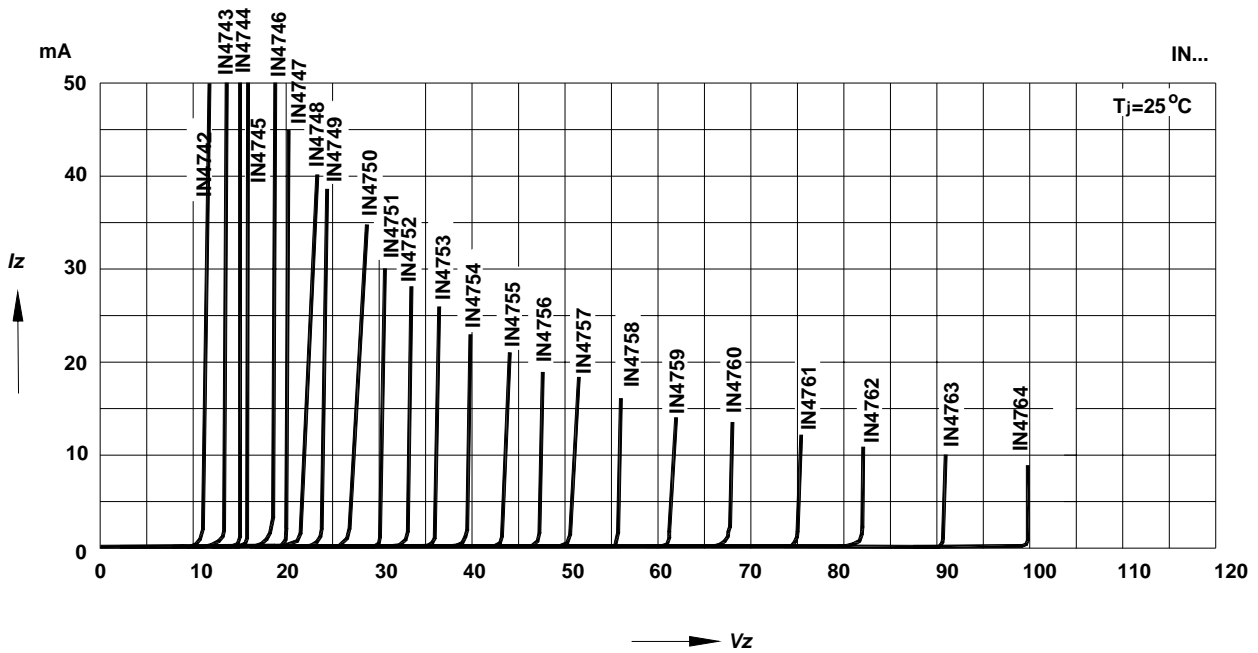
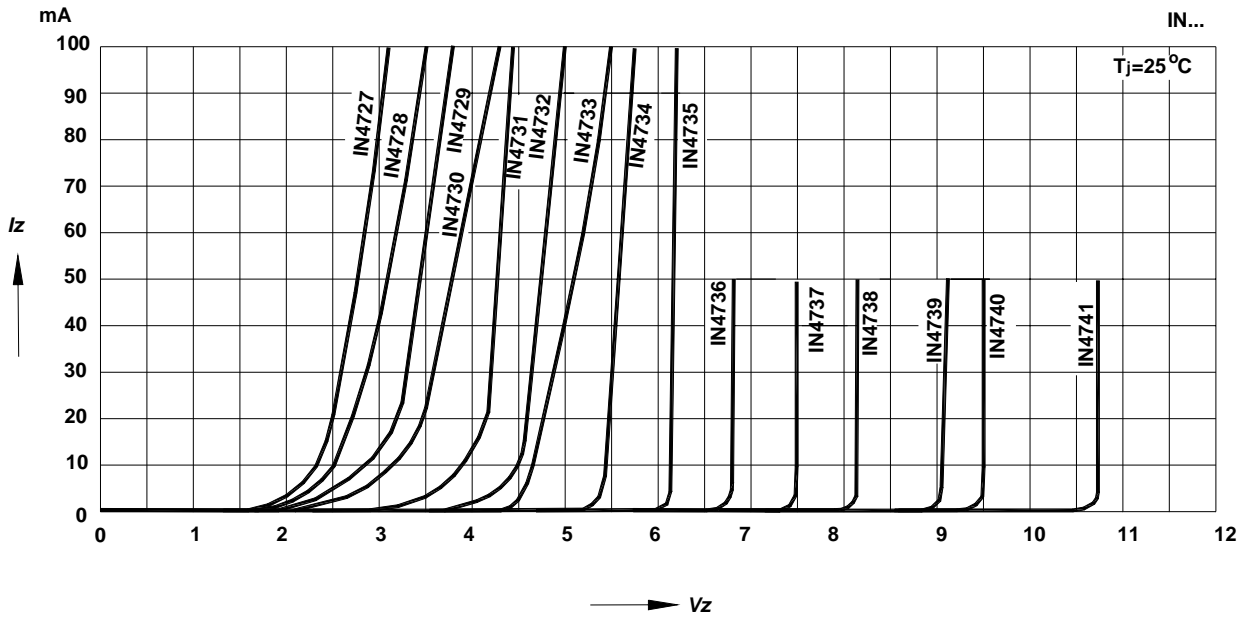

SEMTECH ELECTRONICS LTD.

(Subsidiary of Sino-Tech International Holdings Limited, a company listed on the Hong Kong Stock Exchange, Stock Code: 724)



ISO/TS 16949:2002
Certificate No. 05103



ISO 14001:2004
Certificate No. 7116



ISO 9001:2000
Certificate No. 0506088

Dated : 12/06/2007

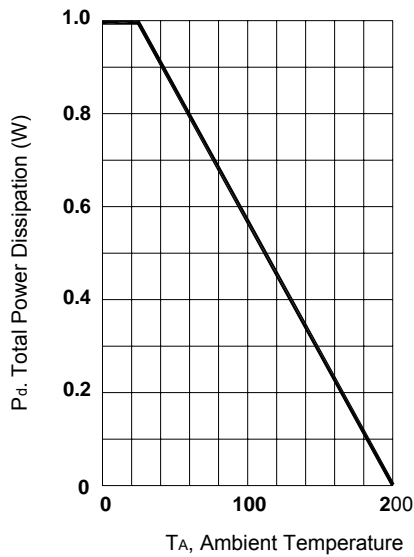

Fig. 1 Power Dissipation vs Ambient Temperature

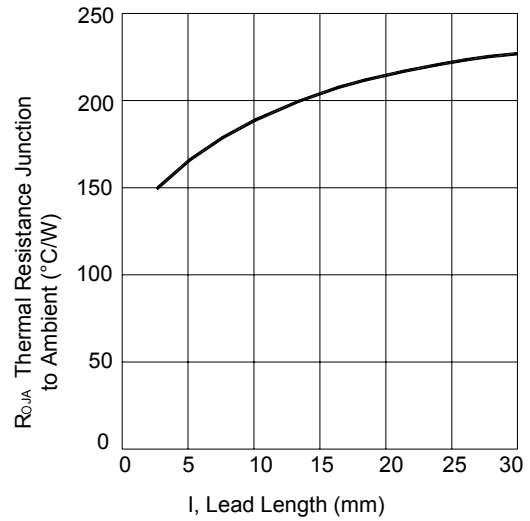

Fig. 2 Typical Thermal Resistance vs. Lead Length

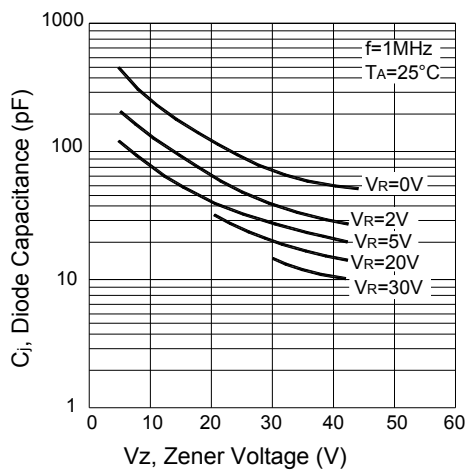

Fig. 3 Junction Capacitance vs Zener Voltage

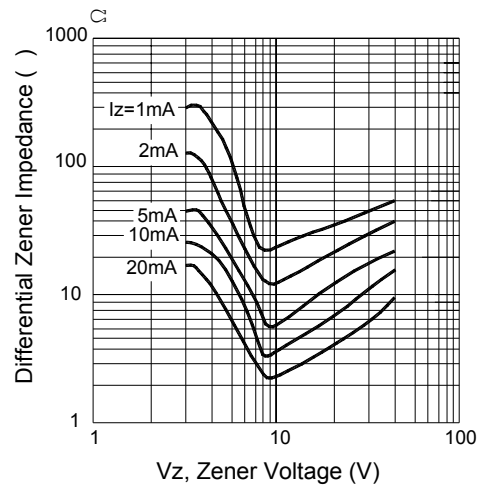
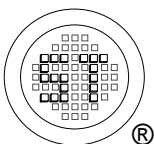

Fig. 4 Typical Zener Impedance vs. Zener Voltage



SEMTECH ELECTRONICS LTD.
 (Subsidiary of Sino-Tech International Holdings Limited, a company listed on the Hong Kong Stock Exchange, Stock Code: 724)



ISO/TS 16949:2002 Certificate No. 05103
 ISO 14001:2004 Certificate No. 7116
 ISO 9001:2000 Certificate No. 0506088

Dated : 12/06/2007