

ST 7812

3-terminal 1 A positive voltage regulator

Features

- Output Current up to 1 A
- Thermal Overload Protection
- Short Circuit Protection
- Output Transistor Safe Operating Area Protection

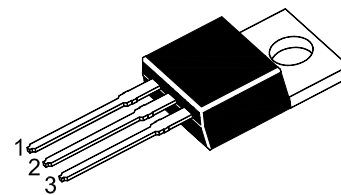

1.Input 2.Common 3.Output
TO-220 Plastic Package

Absolute Maximum Ratings ($T_a = 25\text{ }^\circ\text{C}$)

Parameter	Symbol	Value	Units
Input Voltage	V_I	35	V
Thermal Resistance Junction-Cases	$R_{\theta JC}$	5	$^\circ\text{C/W}$
Thermal Resistance Junction-Air	$R_{\theta JA}$	65	$^\circ\text{C/W}$
Operating Temperature Range	T_{OPR}	0 to + 125	$^\circ\text{C}$
Storage Temperature Range	T_S	- 65 to + 150	$^\circ\text{C}$

Electrical Characteristics

($0\text{ }^\circ\text{C} < T_J < 125\text{ }^\circ\text{C}$, $I_O = 500\text{ mA}$, $V_I = 19\text{ V}$, $C_I = 0.33\text{ }\mu\text{F}$, $C_O = 0.1\text{ }\mu\text{F}$, unless otherwise specified)

Parameter	Symbol	Conditions	Min.	Typ.	Max.	Unit	
Output Voltage	V_O	$T_J = + 25\text{ }^\circ\text{C}$	11.5	12	12.5	V	
		$5\text{ mA} \leq I_O \leq 1\text{ A}$, $P_O \leq 15\text{ W}$ $V_I = 14.5\text{ V to } 27\text{ V}$	11.4	12	12.6		
Line Regulation ¹⁾	Regline	$T_J = + 25\text{ }^\circ\text{C}$	$V_I = 14.5\text{ V to } 30\text{ V}$	-	-	240	mV
			$V_I = 16\text{ V to } 22\text{ V}$	-	-	120	
Load Regulation ¹⁾	Regload	$T_J = + 25\text{ }^\circ\text{C}$	$I_O = 5\text{ mA to } 1.5\text{ A}$	-	-	240	mV
			$I_O = 250\text{ mA to } 750\text{ mA}$	-	-	120	
Quiescent Current	I_Q	$T_J = + 25\text{ }^\circ\text{C}$	-	-	8	mA	
Quiescent Current Change	ΔI_Q	$I_O = 5\text{ mA to } 1\text{ A}$ $V_I = 14.5\text{ V to } 30\text{ V}$	-	-	0.5	mA	
			-	-	1		
Output Voltage Drift	$\Delta V_O / \Delta T$	$I_O = 5\text{ mA}$	-	-1	-	$\text{mV}/^\circ\text{C}$	
Output Noise Voltage	V_N	$f = 10\text{ Hz to } 100\text{ KHz}$, $T_A = + 25\text{ }^\circ\text{C}$	-	76	-	μV	
Ripple Rejection	RR	$f = 120\text{ Hz}$, $V_I = 15\text{ V to } 25\text{ V}$	55	-	-	dB	
Dropout Voltage	V_{Drop}	$I_O = 1\text{ A}$, $T_J = + 25\text{ }^\circ\text{C}$	-	2	-	V	
Output Resistance	R_O	$f = 1\text{ KHz}$	-	18	-	$\text{m}\Omega$	
Short Circuit Current	I_{SC}	$V_I = 35\text{ V}$, $T_A = + 25\text{ }^\circ\text{C}$	-	230	-	mA	
Peak Current	I_{PK}	$T_J = + 25\text{ }^\circ\text{C}$	-	2.2	-	A	

¹⁾ Load and line regulation are specified at constant junction temperature, Changes in V_O due to heating effects must be taken into account separately. Pulse testing with low duty is used.

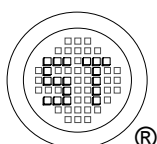

SEMTECH ELECTRONICS LTD.

(Subsidiary of Sino-Tech International Holdings Limited, a company listed on the Hong Kong Stock Exchange, Stock Code: 724)



ISO/TS 16949 : 2002
Certificate No. 05103



ISO 14001:2004
Certificate No. 7116



ISO 9001:2000
Certificate No. 0506098

Dated : 21/06/2006

Typical Performance Characteristics

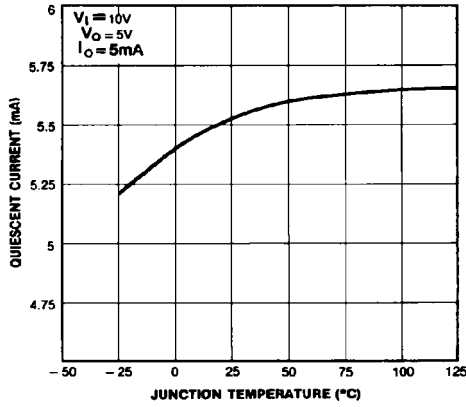

Figure 1. Quiescent Current

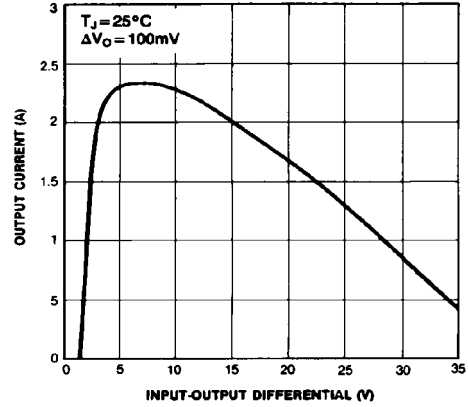

Figure 2. Peak Output Current

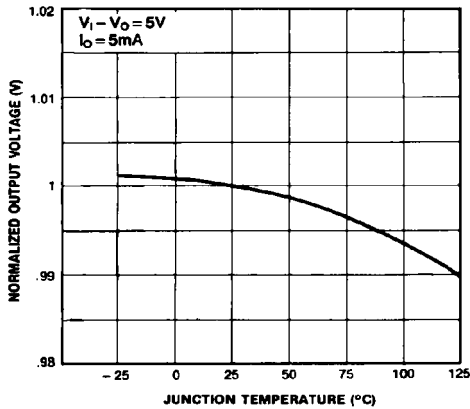

Figure 3. Output Voltage

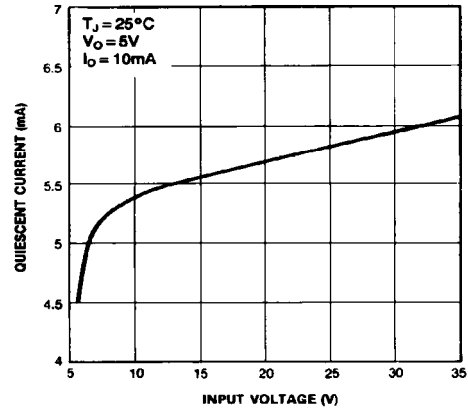
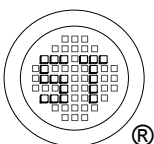

Figure 4. Quiescent Current



SEMTECH ELECTRONICS LTD.
 (Subsidiary of Sino-Tech International Holdings Limited, a company listed on the Hong Kong Stock Exchange, Stock Code: 724)



ISO/TS 16949 : 2002 Certificate No. 05103
 ISO 14001:2004 Certificate No. 7116
 ISO 9001:2000 Certificate No. 0506098

TO-220 PACKAGE OUTLINE

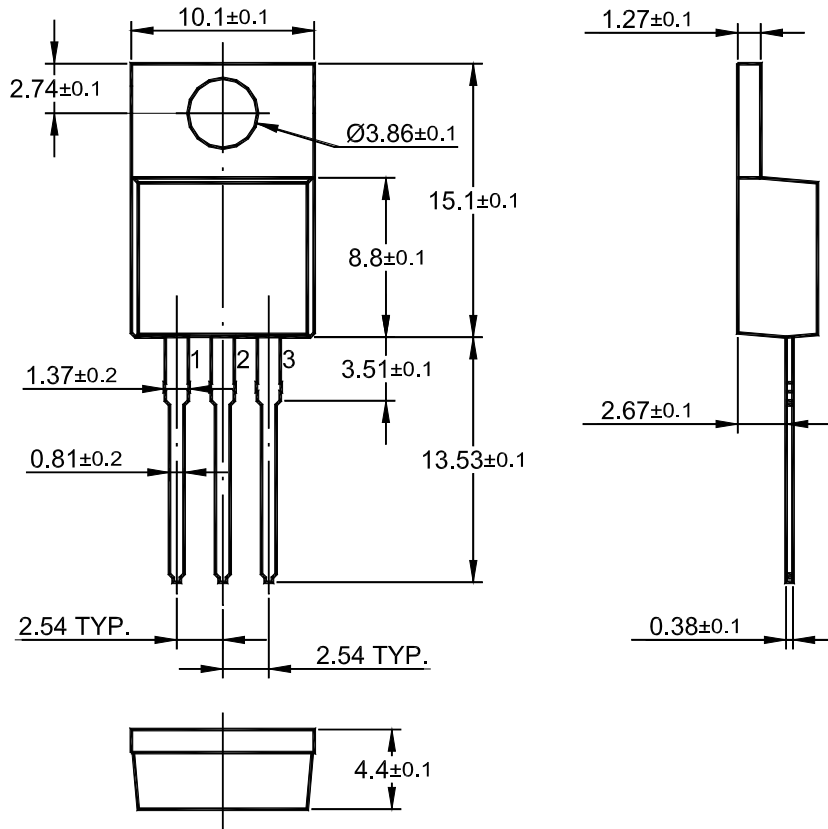

Dimensions in mm

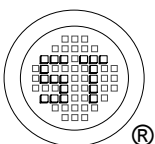

SEMTECH ELECTRONICS LTD.
(Subsidiary of Sino-Tech International Holdings Limited, a company listed on the Hong Kong Stock Exchange, Stock Code: 724)

