

### 1. PART NO. EXPRESSION :

PDC0745C-1R5MF  
 (a) (b) (c) (d) (e)(f)

- (a) Series code
- (b) Dimension code
- (c) Type code
- (d) Inductance code : 1R5 = 1.5uH
- (e) Tolerance code : M = ±20%
- (f) F : Lead Free

### 2. CONFIGURATION & DIMENSIONS :

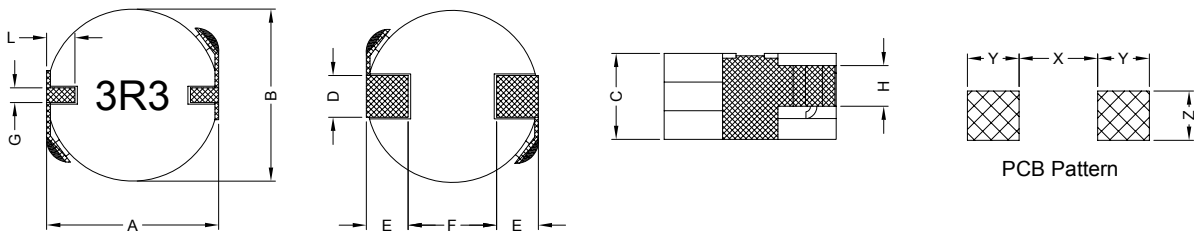

Unit : mm

A	B	C	D	E	F
7.0±0.5	7.0±0.5	4.5 Max.	1.7±0.2	1.7±0.2	3.6±0.5
G	H	L	X	Y	Z
0.6±0.2	1.65±0.2	1.15±0.2	3.20 Ref.	2.10 Ref.	2.00 Ref.

### 3. SCHEMATIC :

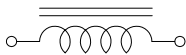

### 4. MATERIALS :

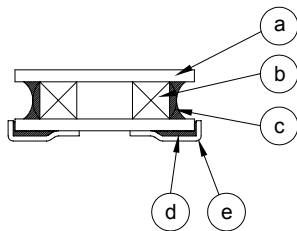

- (a) Core : Ferrite Core
- (b) Wire : Enamelled Copper Wire
- (c) Adhesive : Epoxy
- (d) Adhesive : Epoxy
- (e) Clip : Tin Clip



**RoHS Compliant**

NOTE : Specifications subject to change without notice. Please check our website for latest information.

18.04.2008



**SUPERWORLD ELECTRONICS (S) PTE LTD**

### 5. GENERAL SPECIFICATION :

- a) Test Frequency : 100KHz/0.25Vdc
- b) Ambient Temp. : 20°C
- c) Irms(A) : Will cause coil temperature to rise  $\Delta T \leq 40^\circ\text{C}$
- d) Isat(A) : Will cause  $L_0$  to drop approximately 20%
- e) Operating temp. : -20°C to +85°C ( include self-temp. rise )

### 6. ELECTRICAL CHARACTERISTICS :

Part No.	Inductance ( $\mu\text{H}$ )	Test Frequency ( Hz )	DCR ( $\text{m}\Omega$ ) $\pm 20\%$	Irms ( A ) Max.	Isat ( A ) Max.
PDC0745C-1R5MF	1.5 $\pm 20\%$	100K/0.25V	8.4	6.5	7.0
PDC0745C-3R3MF	3.3 $\pm 20\%$	100K/0.25V	19	5.9	6.0
PDC0745C-4R7MF	4.7 $\pm 20\%$	100K/0.25V	25	4.0	5.0
PDC0745C-5R0MF	5.0 $\pm 20\%$	100K/0.25V	22	3.9	2.9
PDC0745C-100MF	10 $\pm 20\%$	100K/0.25V	36	2.1	2.7
PDC0745C-150MF	15 $\pm 20\%$	100K/0.25V	48	1.8	2.1
PDC0745C-220MF	22 $\pm 20\%$	100K/0.25V	88	2.0	2.5
PDC0745C-330MF	33 $\pm 20\%$	100K/0.25V	128	1.8	2.0
PDC0745C-101MF	100 $\pm 20\%$	100K/0.25V	286	0.8	0.9

### 7. CHARACTERISTICS CURVES :

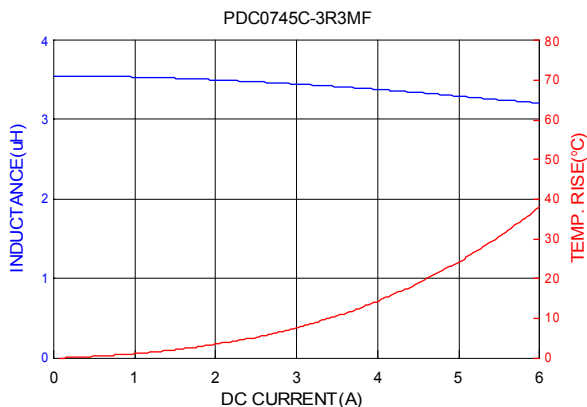
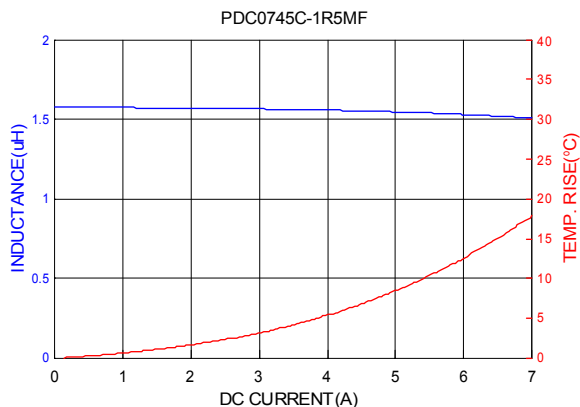

**RoHS Compliant**

NOTE : Specifications subject to change without notice. Please check our website for latest information.

18.04.2008



**SUPERWORLD ELECTRONICS (S) PTE LTD**

7. CHARACTERISTICS CURVES :

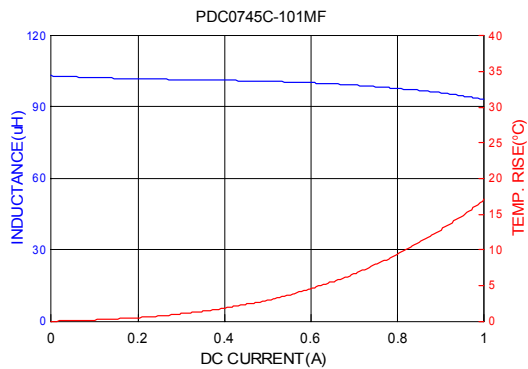
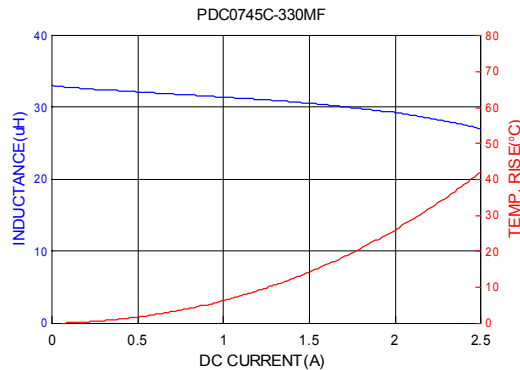
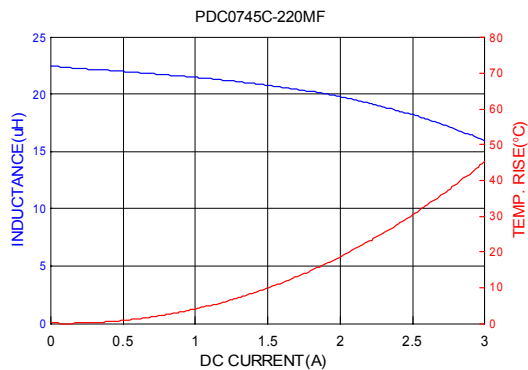
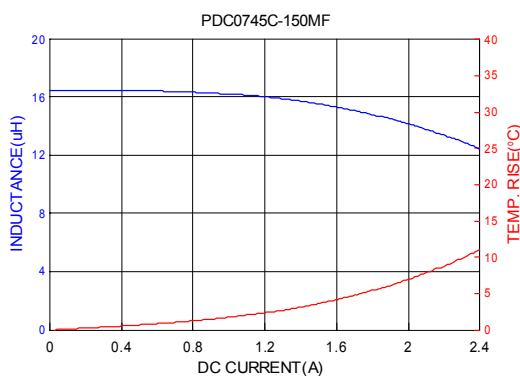
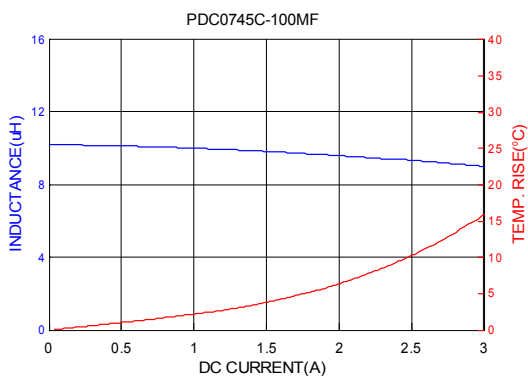
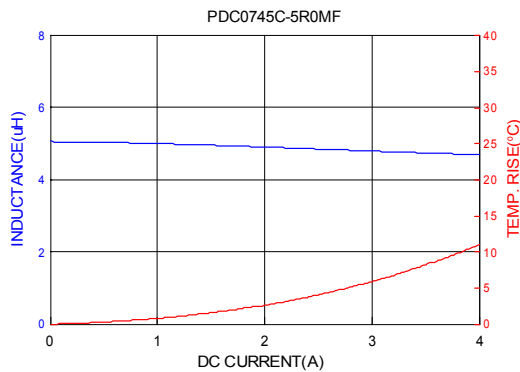
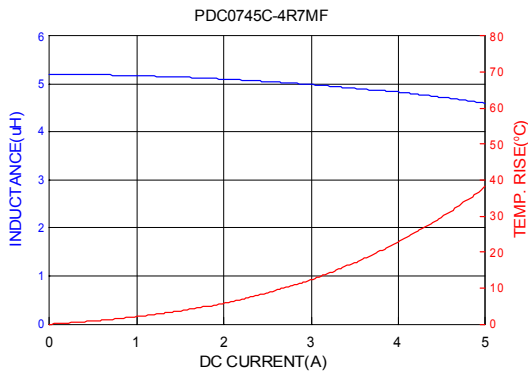

RoHS Compliant

NOTE : Specifications subject to change without notice. Please check our website for latest information.

18.04.2008



SUPERWORLD ELECTRONICS (S) PTE LTD

## 8. ELECTRICAL CHARACTERISTICS :

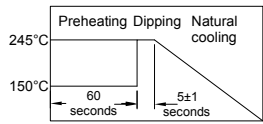
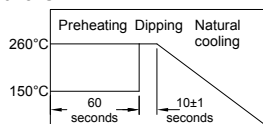
ITEM	JUDGEMENT STANDARD	TEST CONDITION														
Mechanical Performance Test																
Solderability Test	More than 90% of the terminal electrode should be covered with solder.	Preheat : 150°C, 60sec. Solder : lead free (recommend) Solder Temperature : 245±5°C Flux for lead free : rosin Dip Time : 5±1sec. 														
Solder Heat Resistance	1. Appearance : No damage 2. Inductance change : Within ±10% of initial value	Preheat : 150°C Preheat time : 1 min Solder Temperature : 260±5°C Dip Time : 10±1sec.  Measure at room temperature after placing for 24 hrs.														
Reliability Test																
Humidity Resistance	1. Appearance : No damage 2. All electrical and mechanical parameters within tolerance	Temperature : 40±2°C Humidity : 90% to 95% Applied Current : Rated Current Time : 500±12 hours Component should be stabilized at normal condition for 24±2 hours before test.														
High Temperature Life Test	1. Appearance : No damage 2. All electrical and mechanical parameters within tolerance	Temperature : 85±3°C Time : 500+24/-0 hrs Component should be stabilized at normal condition for 24±2 hours before test.														
Low Temperature Life Test		Temperature : -40±3°C Time : 500+24/-0 hrs Component should be stabilized at normal condition for 24±2 hours before test.														
Temperature Cycle (Thermal Shock)		Conditions of 1 cycle. <table border="1" data-bbox="917 1332 1284 1467"> <thead> <tr> <th>Step</th> <th>Temperature (°C)</th> <th>Times (min.)</th> </tr> </thead> <tbody> <tr> <td>1</td> <td>-40±3</td> <td>30</td> </tr> <tr> <td>2</td> <td>25±2</td> <td>Within 3</td> </tr> <tr> <td>3</td> <td>+85±3</td> <td>30</td> </tr> <tr> <td>4</td> <td>25±2</td> <td>Within 3</td> </tr> </tbody> </table> Total : 10 cycles Component should be stabilized at normal condition for 24±2 hours before test.	Step	Temperature (°C)	Times (min.)	1	-40±3	30	2	25±2	Within 3	3	+85±3	30	4	25±2
Step	Temperature (°C)	Times (min.)														
1	-40±3	30														
2	25±2	Within 3														
3	+85±3	30														
4	25±2	Within 3														
Drop	Drop 10 times on a concrete floor from a height of 1m.	No mechanical damage All electrical and mechanical parameters within tolerance														
Electrical Characteristics Test																
Heat Rated Current (Irms)	Idc(Irms) @ Δ ≤ 45°C a. ΔT is the component surface temperature rise scope in room temperature, the test component surface temperature increase not more than 45°C b. Body should not be damaged	1. Ambient temp : 25°C with inhibitive ventilation condition: 2. Applied Current : DC Current, the current shall be step by step increase to the load component.														
Saturation Current (Isat)	Isat @ L ≥ 70% L0 L : test inductance with DC current L0 : the initial inductance without DC current	1. Ambient temp : 25°C 2. Applied Current : DC Current, the current shall be step by step increase to the load component.														

NOTE : Specifications subject to change without notice. Please check our website for latest information.

18.04.2008



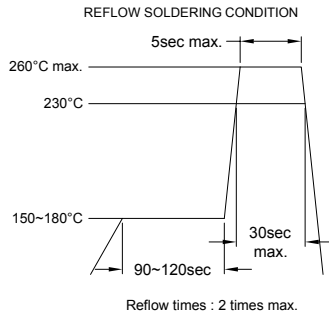

9. PACKAGING INFORMATION :

9-1. Reel Dimension

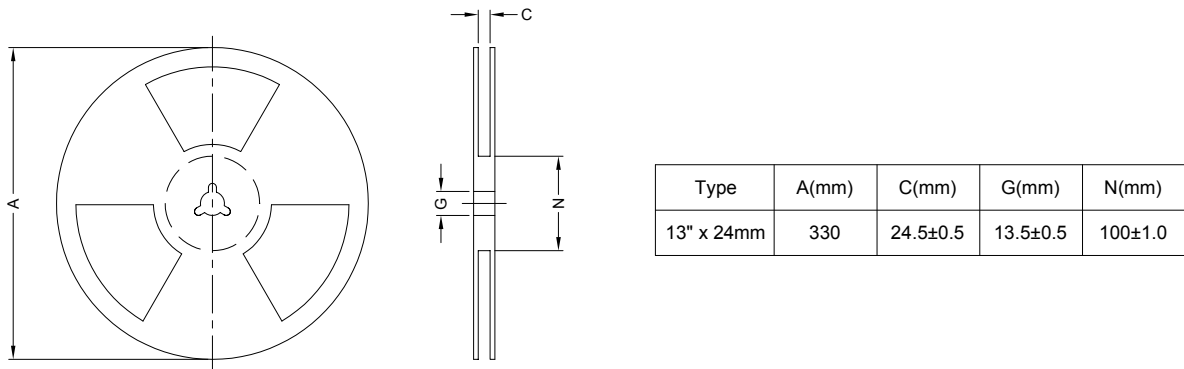

9-2 Tape Dimension / 12mm

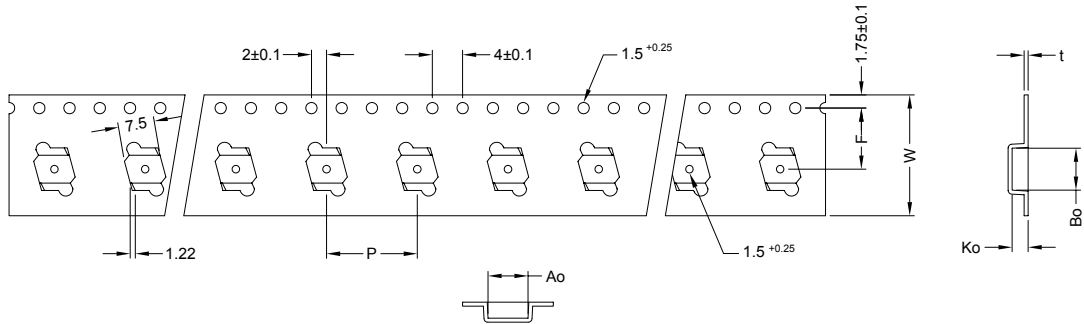

Series	Ao(mm)	Bo(mm)	Ko(mm)	P(mm)	W(mm)	F(mm)	t(mm)
PDC0745C	7.65±0.1	7.65±0.1	4.6±0.1	16.0±0.1	24±0.3	11.5±0.1	0.4±0.05

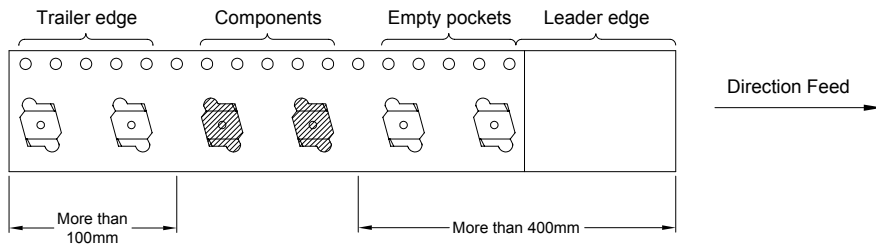

RoHS Compliant

NOTE : Specifications subject to change without notice. Please check our website for latest information.

18.04.2008

**9-3. Packaging Quantity**

Size	PDC0745C
Chip / Reel	1000
Inner Box	2000
Carton	8000

**9-4. Tearing Off Force**

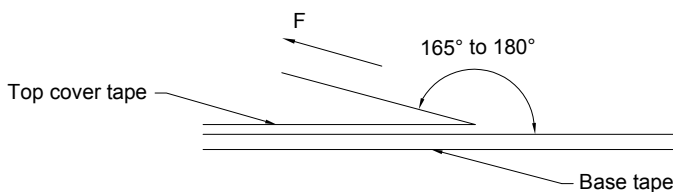

The force for tearing off cover tape is 10 to 125 grams in the arrow direction under the following conditions.

Room Temp. (°C)	Room Humidity (%)	Room atm (hPa)	Tearing Speed (mm/min)
5~35	45~85	860~1060	300

**Application Notice**

**1. Storage Conditions :**

To maintain the solderability of terminal electrodes :

- a) Temperature and humidity conditions : Less than 40°C and 70% RH.
- b) Recommended products should be used within 6 months from the time of delivery.
- c) The packaging material should be kept where no chlorine or sulfur exists in the air.

**2. Transportation :**

- a) Products should be handled with care to avoid damage or contamination from perspiration and skin oils.
- b) The use of tweezers or vacuum pick up is strongly recommended for individual components.
- c) Bulk handling should ensure that abrasion and mechanical shock are minimized.



**RoHS Compliant**

NOTE : Specifications subject to change without notice. Please check our website for latest information.

18.04.2008