

SC-Cut Crystal - Sine Wave - 5.0 Volts

- Frequency Range 5.0MHz to 20.0MHz
- 50.8 x 50.8 x 16.0mm 7 pin metal, solder-sealed package
- Supply Voltage 5.0 Volts
- SC-Cut Crystal
- Sine Wave Output
- EFC (Voltage control) as standard

DESCRIPTION

OC22E5S series oven-controlled crystal oscillators are close tolerance OCXOs with excellent phase noise performance.

SPECIFICATION

Crystal Cut:	SC-cut
Output Waveform:	Sine Wave
Supply Voltage:	+5.0 VDC $\pm 0.2V$
Frequency Range:	5.0MHz to 20.0MHz
Initial Calibration Tolerance:	± 0.1 ppm max. (at $V_{CON} + 2.5V$)
Frequency Stability	
over 0° to +60°C:	± 0.01 ppm
over -20° to +70°C:	± 0.02 ppm
over -40° to +85°C:	± 0.03 ppm
vs. Voltage Change:	$< \pm 1.0$ ppb for $\pm 5\%$ change
vs. Ageing:	± 0.5 ppb max per day ± 50 ppb per first year ± 150 ppb over 10 years
vs. Load Change:	$< \pm 1.0$ ppb for $\pm 5\%$ change

Warm-up Time: 5 minutes max. to within ± 10 ppb of nominal freq.

Voltage Control

Control Voltage Centre:	+2.5 Volts (V_{CON})
Freq. Deviation Range:	± 0.5 ppm min., ± 1 ppm max. ref. to 25°C and O.T.R.
Control Voltage Range:	2.5V ± 2.0 Volts
Transfer Function:	Positive: Increasing control voltage increases output frequency
Input Impedance:	100k Ω minimum
EFC Linearity:	$\pm 10\%$ maximum

Power Dissipation: 2.0W max. steady state
6.0W max. at turn on

Output

Output level:	+2dBm typ., +8dBm max into 50 Ω load
Harmonics:	-30dBc min.
Spurious:	-75dBc min.

Reference Voltage: +4.0 ± 0.3 VDC or custom

Environmental

Storage Temperature:	-55° to +125°C
Shock:	2000g, 0.3ms $\frac{1}{2}$ sine
Vibration:	10 ~2000Hz / 10g

PHASE NOISE (at 10MHz)

Offset	dBc/Hz
1Hz	-85
10Hz	-120
100Hz	-140
1kHz	-145
10kHz	-150

OUTLINE & DIMENSIONS

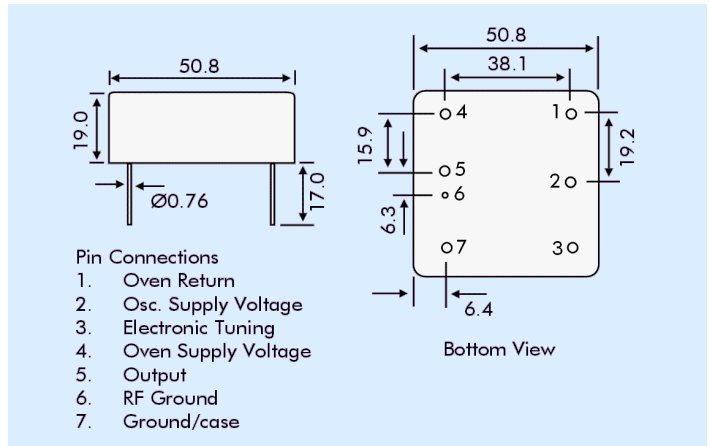

TEST CIRCUIT

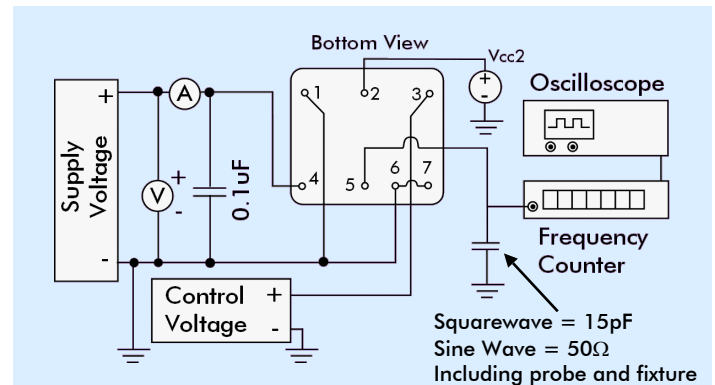

PART NUMBER FORMAT

Example: **OC22GE5S-10.000-0.10/-20+70**

