

Features

- Monolithic Construction
- Low Insertion Loss (< 0.5 dB)
- Good Port to Port Isolation (> 20 dB)
- Low Amplitude (0.2 dB) and Phase Imbalance (1°).
- Output Port Isolation ~30 dB
- SOT-26 Low Cost Miniature Plastic Package
- RoHS Compliant

Description and Applications

M/A-COM's MAPD-000900-12920T is a 50 Ω Characteristic Impedance, Monolithic Passive Integrated Circuit designed to provide a 0 degree phase shift during an RF power split. The die uses M/A-COM's unique glass process to realize low loss and high Q passive elements while retaining the advantages of overall size and exceptional reproducibility.

These power splitters/combiners are well suited for use in 50 Ω Rx/Tx system applications particularly where small size and parametric repeatability are essential. Typical applications include usage within RF systems where synthesizer sources are used to drive separate receiver and transmitter sections.

Absolute Maximum Ratings¹

Parameter	Maximum Ratings
Operating Temperature	-40 °C to +85 °C
Storage Temperature	-65 °C to +150 °C
RF C.W. Incident Power	+30 dBm C.W.

1. Exceeding these limits may cause permanent damage.

SOT-26 Package Outline (Topview)

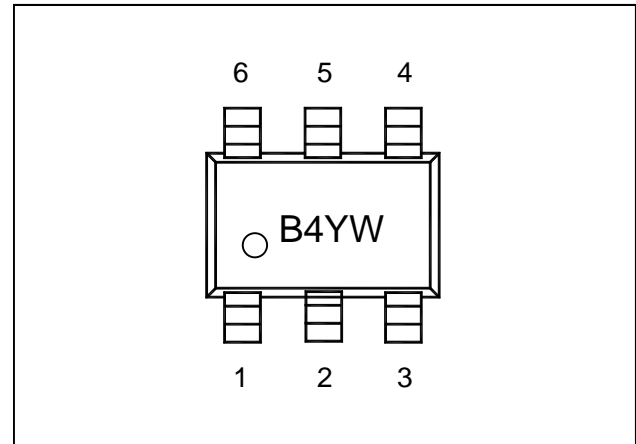

Pin Configuration

PIN	Function	PIN	Function
1	RF Output	4	N/C
2	GND	5	RF Input
3	RF Output	6	N/C

Schematic

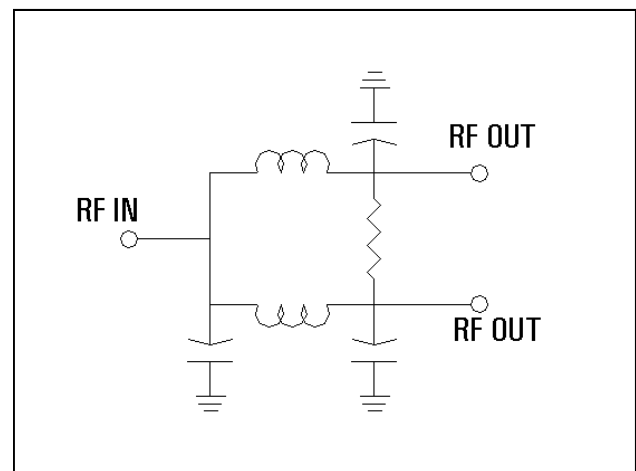

Electrical Specifications @ +25 °C

Parameter	Frequency Range	Units	Min.	Typ.	Max.
Insertion Loss	900 MHz 800-980 MHz	dB		0.3 0.3	0.5 0.6
Isolation	900 MHz 800-980 MHz	dB	28 20	30.0 27.0	
Input Return Loss	900 MHz 800-980 MHz	dB	19 16	21.0 21.0	
Output Return Loss	900 MHz 800-980 MHz	dB	26 21	28.0 28.0	
Amplitude Balance	900 MHz 800-980 MHz	dB		0.05 0.05	0.2 0.2
Phase Balance	900 MHz 800-980 MHz	deg		0.1 0.3	0.5 1.0

Typical Performance Curves

Temperature Legend: (- - - - - -40°C, — 25°C, - - - - - 85°C)

RF Input to RF Output Insertion Loss

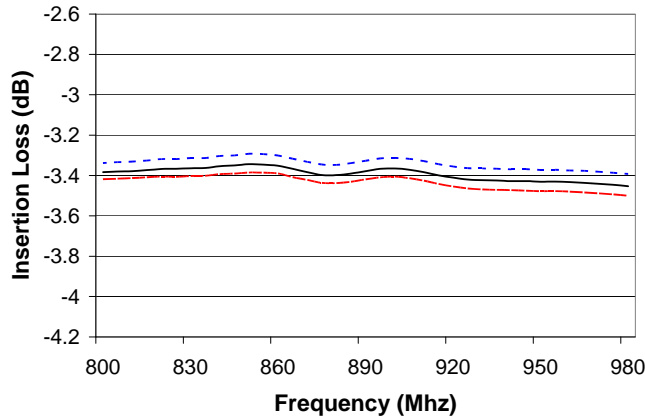

Output Port to Port Isolation

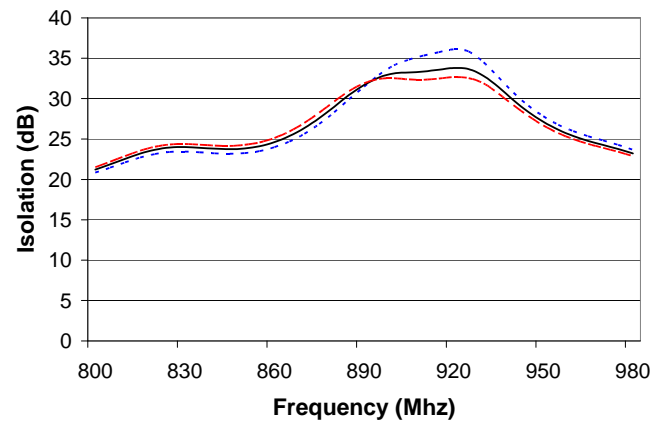

Input Return Loss

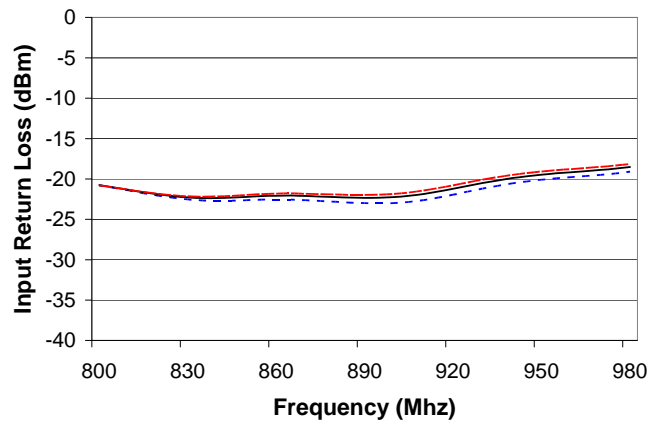

Output Return Loss

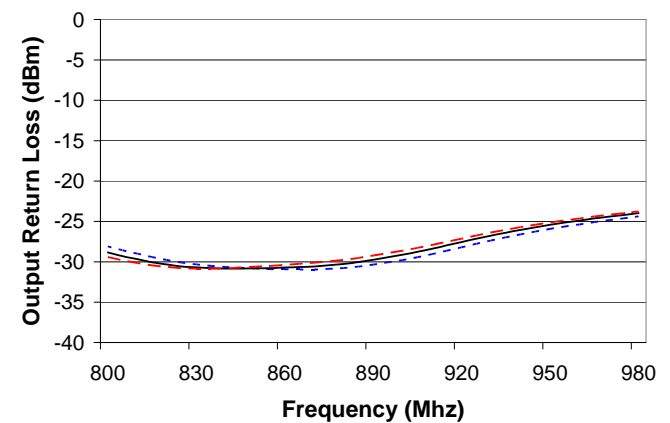

Delta Magnitude

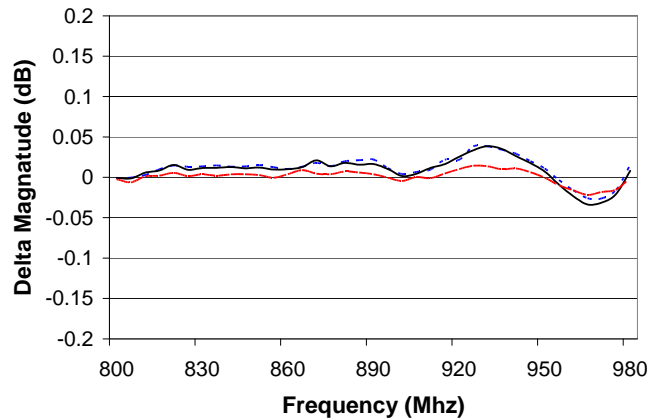

Delta Phase

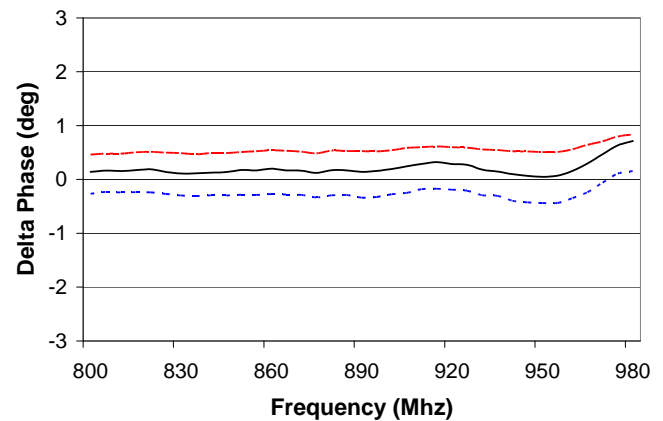

Case Style - SOT-26

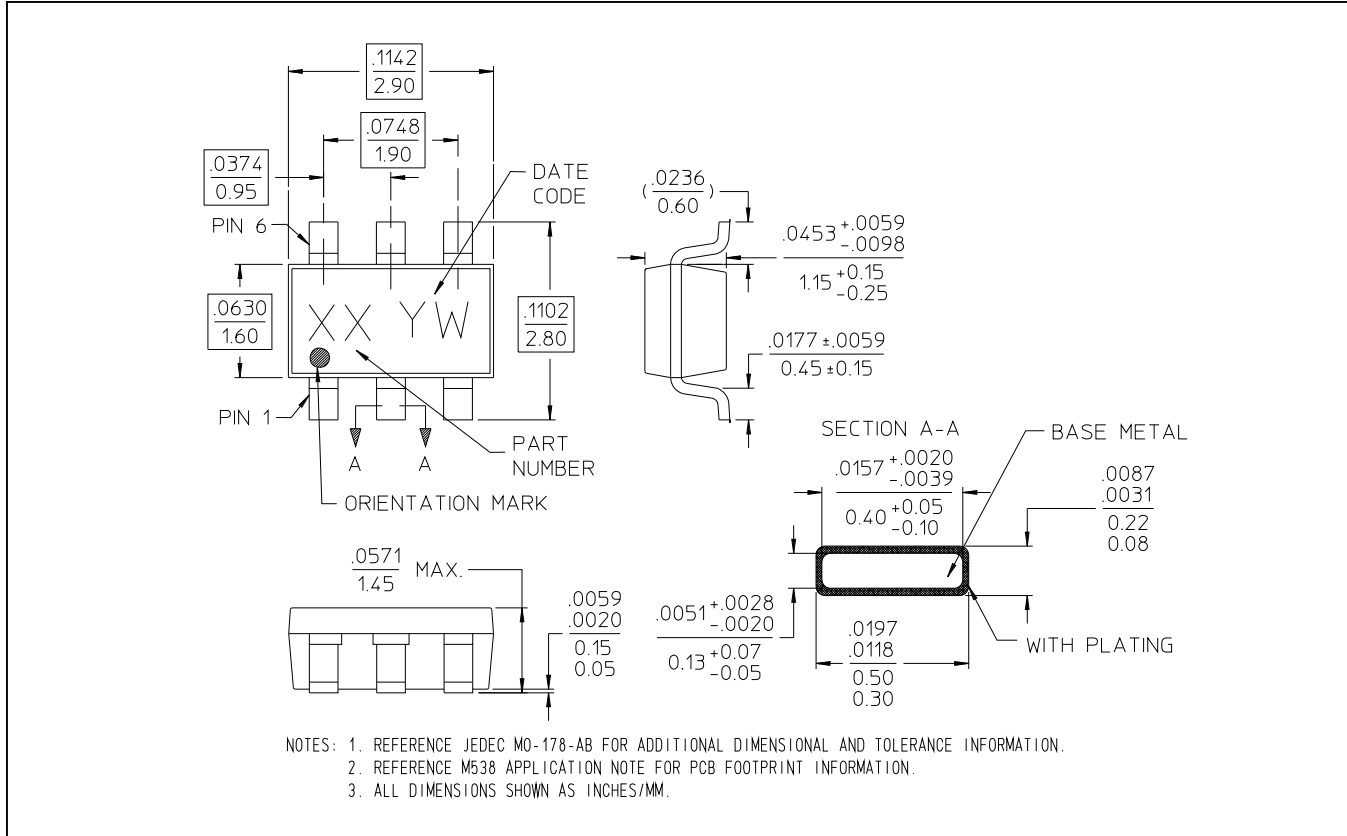

Ordering Information

Part Number	Package
MAPD-000900-12920T	Tape and Reel