

Power-over-Ethernet (PoE) Application Notes

PoE - the Cost-Effective Means of Power Supply

In addition to data communications between the two devices, Power-over-Ethernet (PoE) enables an Ethernet Switch/Hub to power a remote device over an existing LAN cable. Without PoE, any remote device needs to be powered independently. Typically, device power is derived from an AC-DC adapter or at board level inside the device. This adds cost and requires locating the device near a source of AC power.

Device installation is further complicated by different safety codes, AC voltages and wall plugs around the world. PoE avoids these problems by supplying low-voltage DC power directly to the *Powered Device* (PD) from the *Power Sourcing Equipment* (PSE) that is located in the Ethernet Switcher or mid-span Hub and eliminates the complexity of AC power sources.

To ensure that all equipment is protected and devices operate properly when connected, the IEEE established a universal standard (IEEE802.3af). This specifies the power requirements of the PSE and the PD, and the communication protocol between the two - regardless of manufacturer or configuration.

Traditional Power-over-Ethernet

The 12.95W power limit was adequate for IP telephony when IEEE802.3af was initially approved in 2003. Network cameras, were initially the most prevalent application enabled by the Power-over-Ethernet standard.

However, the popularization of WLAN applications triggered developers' and marketers' inventiveness for creating more power-hungry derivative devices, such as Video IP Phones, Multi-channel WLAN Access Points (like the ones in the IEEE802.11n upcoming MIMO standard) and Pan-Tilt-Zoom IP Cameras.

All these devices typically require between 13W and 30W - more than the normally available 13W.

Enhancing Power-over-Ethernet

In December, 2004, the IEEE802 established a PoEPlus group to study the market needs and possible technical solutions to address higher power applications while maintaining backward compatibility with the original standard. In September, 2005, the group set and approved, as binding, objectives for the IEEE802.3at Power-over-Ethernet Enhancements. One of the main objectives was providing maximum power to PDs as allowed within practical limits of at least 30W.

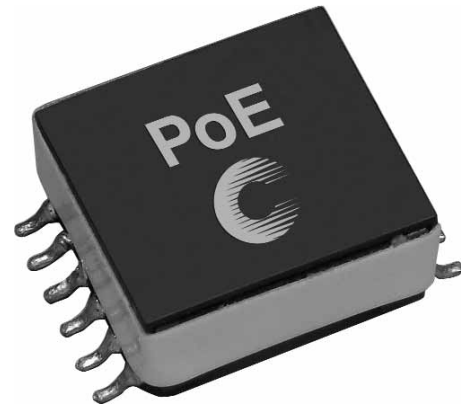

Converter Topology Choices: Flyback Vs. Forward

Flyback or *forward* converter topologies are normally used in a powered device DC-DC converter, depending on the PD's voltage and current requirements.

Flyback Topology (See Figure 1)

Benefit: Lowest cost for <6A output currents.

When to Use: Typically for output voltages greater than 2.5V. Recommended for multi-output, voltages (>12V) and for applications requiring lowest cost.

Advantages:

- Output isolated from input.
- No output inductor required.

Disadvantages:

Higher output ripple current results in higher output capacitor cost and medium efficiency due to higher peak and rms currents.

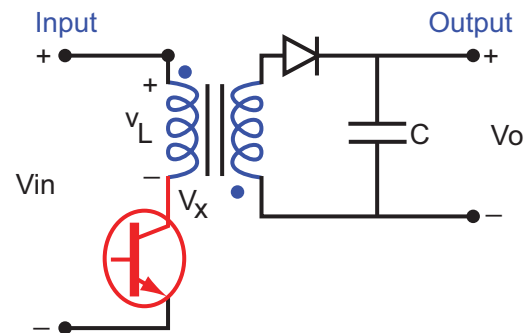

Figure 1. Transformer Flyback Topology

Forward Topology (See Figure 2)

Benefit: Lowest cost for >6A output currents.

When to Use: Typically for output voltages less than 12 V. Recommended for multi-output voltages (<2.5V) and for applications requiring highest efficiency.

Advantages:

- Low output ripple current results in lower output capacitor cost.
- Higher efficiency due to lower peak and rms currents can utilize synchronous rectification.
- Isolated output.

Disadvantages:

Requires additional components including an output energy storage inductor and additional rectifying device (diode or MOSFET).

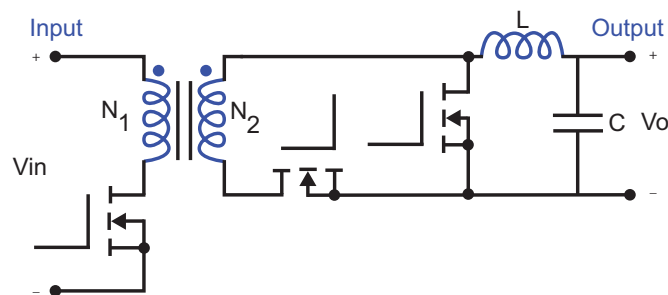
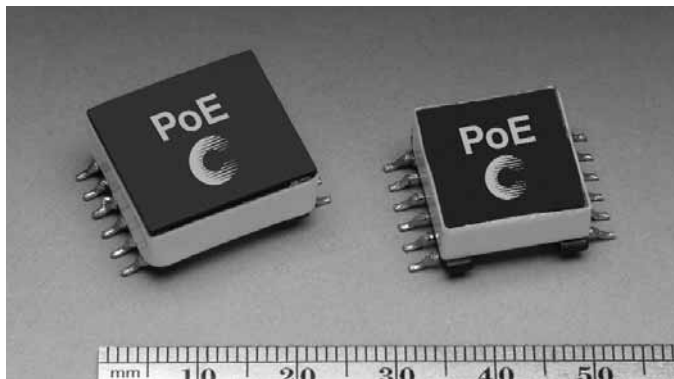

Figure 2. Transformer Forward Topology.

Cooper Bussmann® Coiltronics® Transformers



Cooper Bussmann Coiltronics 4 to 13 Watt PoE Transformers.

The Coiltronics lines of RoHS compliant PoE configurable transformers are available for use with a wide variety of PWM controllers from several IC manufacturers, providing PD supply solutions that utilize either *flyback* or *forward* converter topologies.

Flyback and *forward* DC-DC converters solve the isolation requirements of the PoE standard. *Forward* and *flyback* switcher topologies can use Coiltronics PoE transformers to isolate the PDs PoE interface from the rest of its circuitry while stepping down the PoE input voltage to power the PD circuits.

Coiltronics *flyback* PoE transformers support 1500Vac isolation in the power converter with feedback voltage of 11V at 0.1A. Available in 4W, 7W and 13W, the transformers accept input voltage ranging from 29.5V to 60V using a nominal 250kHz switching frequency.

Coiltronics PoE transformers feature split primary and secondary windings to minimize leakage inductance (the result of imperfect magnetic linking of one winding to another). These transformers allow multiple output variations. 3.3V and 5V PoE transformers support three outputs while 12V transformers support two outputs. These three transformers have parallel windings with identical output voltage.

These enable the windings to be used:

- Independently for isolated circuits
- Paralleled for higher current
- Connected in series to generate higher voltages.

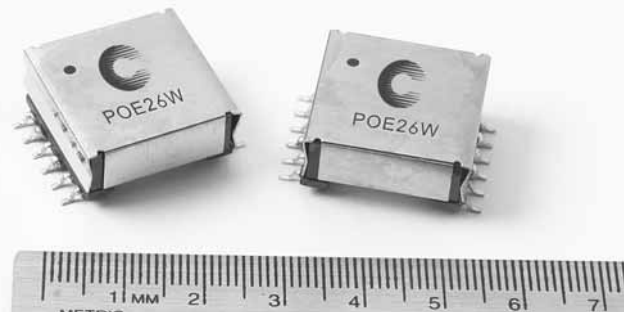

Cooper Bussmann Coiltronics 26 Watt PoE Transformers.

Coiltronics also offers transformers for *forward* converters with synchronous rectification support, 1500Vac isolation, isolated feedback voltage and can deliver up to 26W. These transformers accept an input voltage range from 29.5V to 60V using a nominal 300kHz switching frequency.

These components operate in ambient temperatures between -40°C and +85°C with a maximum operating temperature of 125°C.

The Coiltronics Versa-Pac® product line offers more than 500 usable inductor or transformer configurations. This same user-configurable concept is used in the PoE transformer family (VER suffix devices). Connecting the windings in parallel increases the current carrying capability while connecting in series increases the output voltage. These devices provide even greater flexibility in the number of voltage and current combinations than are available in this standard off-the-shelf transformer series.

Typical PoE/PD Configurable Transformer Applications

- For IEEE 802.3af-compliant Power-over-Ethernet applications.
- UPS, VoIP Phone, wireless LAN access point, Bluetooth access point, network camera, building access systems.
- Retail point-of-information systems.
- Vending/gaming machines.

Flyback Transformer - 4, 7 & 13 Watts

Part Number	Watts	Inductance (μH)	Output	DCR Primary (Ω)	DCR Secondary (Ω)	Leakage Inductance (μH) typ.	Primary Current Pk (A dc)	Turn Ratios Schm 1: Pins pri(1-3):fb(5-6):v1(12-7): v2(11-8): v3(10-9) Schm 2: Pins pri(1-3):fb(5-6): v1(12-10):v2(11-9)	Schematic	Dimension Size
PoE4W3x3.3-R	4	200	(3)x3.3V@0.45A	0.5	0.07	2.75	0.65	1 : 0.52 : 0.16 : 0.16 : 0.16 +/-1%	1	1
PoE4W3x5.0-R	4	200	(3)x5.0V@0.30A	0.5	0.27	2.5	0.65	1 : 0.52 : 0.26 : 0.26 : 0.26 +/-1%	1	1
PoE4W2x12-R	4	200	(2)x12.0V@0.20A	0.5	0.74	1.4	0.65	1 : 0.52 : 0.60 : 0.60 +/-1%	2	1
PoE7W3x3.3-R	7	100	(3)x3.3V@0.75A	0.275	0.03	1	1	1 : 0.529 : 0.176 : 0.176 : 0.176 +/-1%	1	1
PoE7W3x5.0-R	7	100	(3)x5.0V@0.50A	0.275	0.095	1	1	1 : 0.529 : 0.265 : 0.265 : 0.265 +/-1%	1	1
PoE7W2x12-R	7	100	(2)x12.0V@0.30A	0.275	0.25	1	1	1 : 0.529 : 0.588 : 0.588 +/-1%	2	1
PoE13W3x3.3-R	13	100	(3)x3.3V@1.35A	0.25	0.032	1.5	1.6	1 : 0.529 : 0.176 : 0.176 : 0.176 +/-3%	1	2
PoE13W3x5.0-R	13	100	(3)x5.0V@0.90A	0.25	0.075	1.2	1.6	1 : 0.529 : 0.265 : 0.265 : 0.265 +/-3%	1	2
PoE13W2x12-R	13	100	(2)x12.0V@0.60A	0.25	0.28	1	1.7	1 : 0.529 : 0.647 : 0.647 +/-3%	2	2

Part Number	Watts	Inductance (μH)	Output	DCR Primary (Ω)	DCR Secondary V1/V2/V3	Leakage Inductance (μH) typ.	Primary Current Pk (A dc)	Turn Ratios Schm 2: Pins pri(1-3):fb(5-6):v1(12-10):v2(11-9) Schm 3: Pins pri(1-3):fb(5-6):v1(12-11):v2(10-9):v3(8-7)	Schematic	Dimension Size
PoE13W3VERS-R	13	100	V1:7.0V@1.1A, V2:(1)x3.3V@1.1A, V3:1.8V@1.1A	0.25	0.025/0.042/0.085	1	1.7	1 : 0.529 : 0.350 : 0.176 : 0.088 +/-3%	3	2
PoE13W2VERS-R	13	100	V1:5.0V@1.6A, V2:3.3V@1.6A	0.25	0.023/0.038/na	1.2	1.7	1 : 0.529 : 0.265 : 0.176 +/-3%	2	2

For full product information and a listing of all available inductor values, see <http://www.cooperbussmann.com/datasheets/elx>, Data sheet number 4316.

Dimensions - mm

	A max.	B ref.	C max.	D ref.	E max.	F ref.	G ref.	H ref.	I ref.	J	K	L ref.	M max.	N	O
Size 1	17.1	16.0	22.3	0.7	8.4	3.0	0.1	0.4	14.49	1.79	3.43	16.88	23.74	2.54	0.75
Size 2	18.0	18.0	24.6	0.7	10.0	3.3	0.1	0.4	14.25	1.75	3.43	19.14	26.0	2.5	0.75

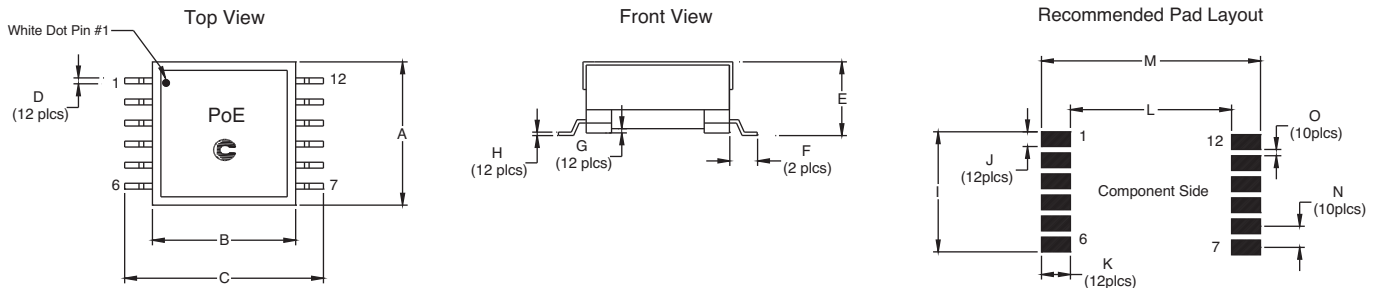

1) Tolerances A - H are ± 0.25mm unless specified otherwise. 2) Tolerances I - O are ± 0.10mm unless specified otherwise. 3) All soldering surfaces are co-planar to within ± 0.102mm.

Schematics

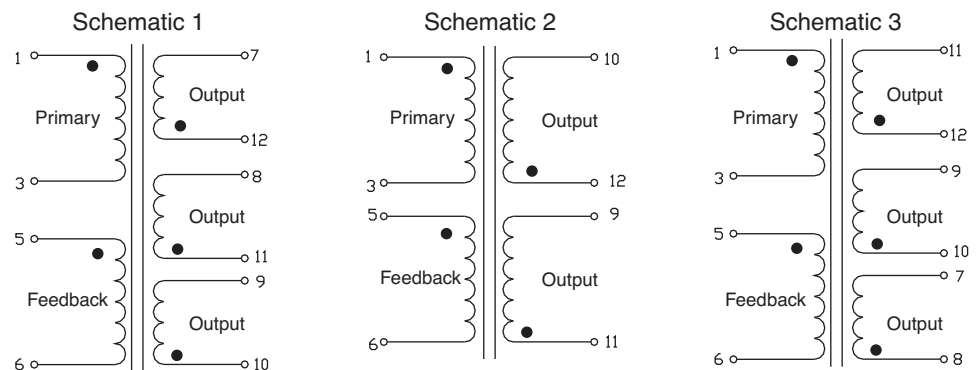

Forward Transformers - 26 Watts

Part Number	Watts	Primary Inductance (μH)	Output	Bias	Sync.	DCR Primary (Ω) max	DCR Secondary (Ω) max	DCR Bias (Ω) max	DCR Sync. (Ω) max	Leakage Inductance (μH) typ.	Primary Current Pk (A)dc	Turn Ratio Pins Primary (2-4): V1, (12-10): V2 (11-9): Bias, (1-6): Sync. (7-8)
PoE26W3.3VS5-R	26	160	(2)x3.3V @4.0A	10.0V @0.1A	5V @0.1A	0.1	0.03	0.9	0.42	1	2.6	1:0.29:0.29:0.83:0.42 +/-2%
PoE26W3.3VS10-R	26	160	(2)x3.3V @4.0A	10.0V @0.1A	10V @0.1A	0.1	0.03	0.9	0.9	1	2.6	1:0.29:0.29:0.83:0.83 +/-2%
PoE26W5V-R	26	160	(2)x5.0V @2.6A	10.0V @0.1A	5.0V @0.1A	0.1	0.05	0.9	0.42	1	2.6	1:0.42:0.42:0.83:0.42 +/-2%

For full product information and a listing of all available inductor values, see <http://www.cooperbussmann.com/datasheets/elx>, Data sheet number 4339.

Dimensions (mm)

A max.	B ref.	C max.	D ref.	E max.	F ref.	G ref.	H ref.	I ref.	J	K	L ref.	M max.	N	O
21.5	22.0	28.5	0.7	10.8	2.95	0.1	0.4	17.25	2.25	3.15	23.2	29.5	3.0	0.75

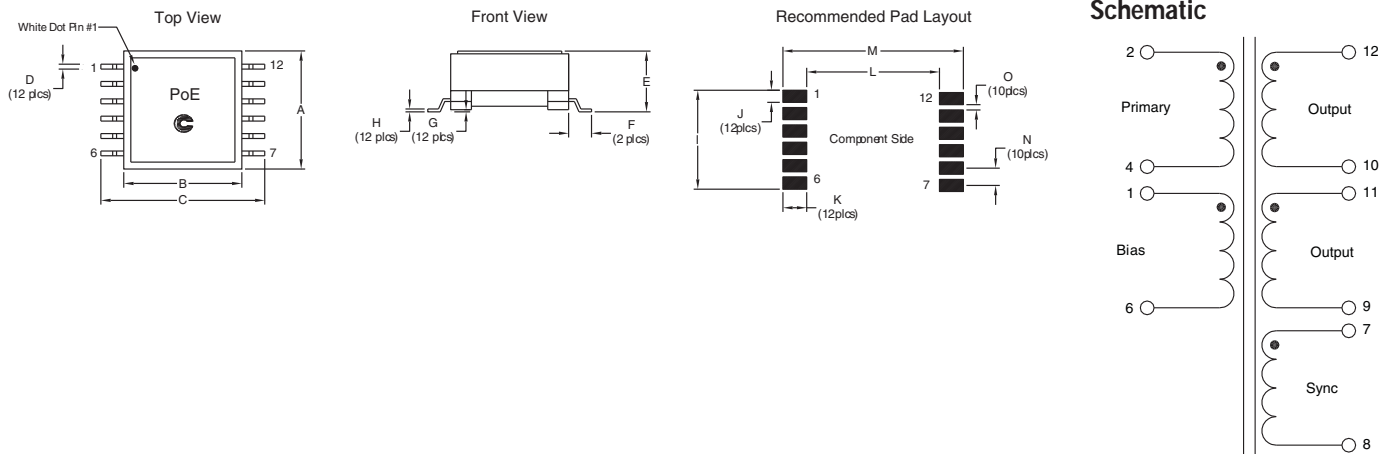

The Cooper Bussmann® Coiltronics® brand of magnetics specializes in standard and custom solutions, offering the latest in state-of-the-art low-profile high power density magnetic components. We remain at the forefront of innovation and new technology to deliver the optimal mix of packaging, high efficiency and unbeatable reliability. Our designs utilize high frequency, low core loss materials, and new and custom core shapes in combination with innovative construction and packaging to provide designers with the highest performance parts available on the market. The Coiltronics Brand product line of power magnetics continually expands to satisfy shifts in technology and related market needs. Standard Product Categories include:

- Shielded Drum Inductors
- Unshielded Drum Inductors
- High Current Inductors
- Toroidal Inductors
- Specialty Magnetics
- Custom Magnetics

Please visit <http://www.cooperbussmann.com/datasheets/elx> to see the wide variety of inductor solutions we have to offer.

Order samples online - www.cooperbussmann.com