



USB Solutions



*Covering protection, filtering and switching
devices from ON Semiconductor.*



Integrated Solutions for USB Line Protection and Termination

ON Semiconductor provides a selection of integrated solutions for USB line protection and termination. Integrated IC solutions combine diodes with resistive and capacitive elements into a single package, providing:

- improved parametric stability
- reduced parasitic inductance
- component count reduction
- board space reduction
- simplified supply chain
- lower overall system cost

Related Application Notes (download from www.onsemi.com)

- ESD Protection for Dual USB 2.0 Port Using the Low Capacitance TVS Diode Array, NUP4201DR2 Device – download AND8082/D
- EMI Filtering, USB Upstream Line Termination and ESD Protection Using the STF202 Device – download AND8074/D
- MicroIntegration Technology Solutions for Protection in High Speed I/O Data Lines – download AND8104/D
- Design Considerations for ESD/EMI Filters: (Almost Everything You Wanted to Know About EMI Filters and Were Afraid to Ask) – download AND8200/D
- Solving EMI and ESD Problems with Integrated Passive Device Low Pass Pi Filters - download AND8026/D

Speed of Data Transport

Port	Speed
Serial Port	0.115 Mbit/s
Standard Parallel Port	0.92 Mbit/s
USB 1.1	
Low Speed	1.5 Mbit/s
High Speed	12 Mbit/s
USB 2.0	
Low Speed	1.5 Mbit/s
Full Speed	12 Mbit/s
High Speed	480 Mbit/s

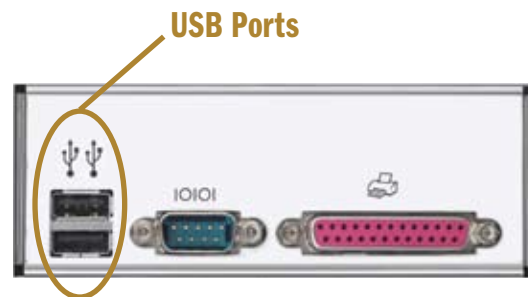



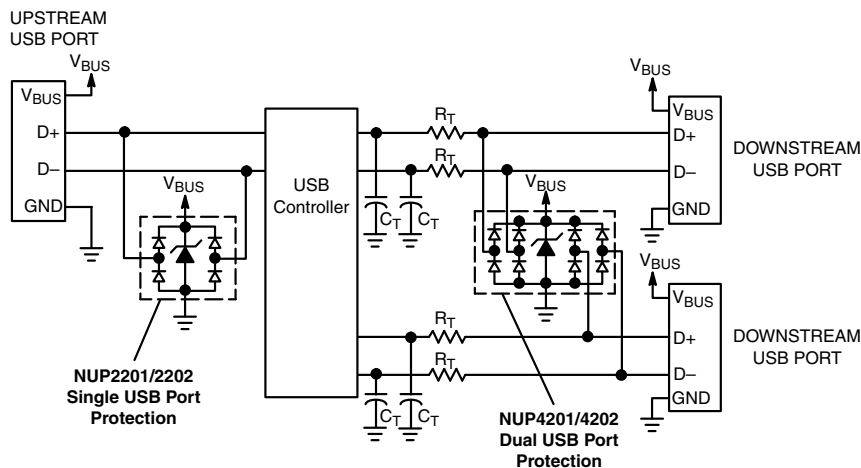





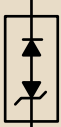



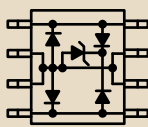

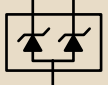

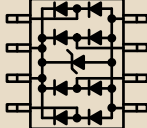

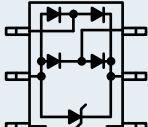

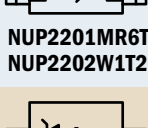

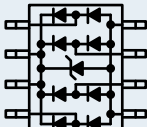

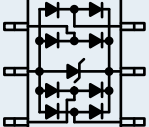

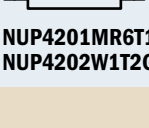

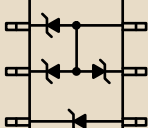

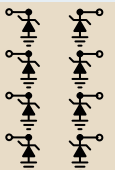
Typical USB Line Protection Application

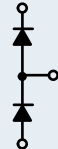

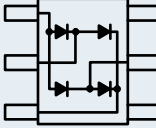
USB Line Protection Devices

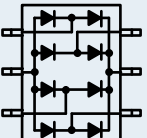





Integrated protection devices for USB from ON Semiconductor can replace up to 9 discrete devices, minimize board space and simplify board layouts. Our portfolio includes Low-, Full- and High-Speed USB solutions. All of our devices are IEC61000-4-2 compliant.

	1-Line (1/2 Port)	2-Lines (1 Port)	4-Lines (2 Ports)
Low & Full Speed I/O Lines + VBUS	  <p>SL05T1G [Ⓜ] SOT-23</p>   <p>ESD9A5.0ST5G [Ⓜ] SOD-923</p>	  <p>LC03-6R2 S0-8</p>   <p>ESD7A5.0DT5G* [Ⓜ] SOT-723</p>	  <p>SRDA05-4R2 S0-8</p>
Low, Full & High Speed I/O Lines + VBUS	—	  <p>NUP2201MR6T1G [Ⓜ] TSOP-6</p>   <p>NUP2202W1T2G [Ⓜ] SC-88</p>	  <p>NUP4201DR2 S0-8</p>   <p>NUP4201MR6T1G [Ⓜ] TSOP-6</p>   <p>NUP4202W1T2G [Ⓜ] SC-88</p>
Low, Full & High Speed I/O Lines	—	  <p>NUP4060AXV6T1G [Ⓜ] SOT-563</p>	  <p>NUP8010MNT1G [Ⓜ] DFN-8</p>
Low, Full & High Speed I/O Lines	  <p>NUP1301ML3T1G [Ⓜ] SOT-23</p>	  <p>NUP2301MW6T1G [Ⓜ] SC-88</p>	  <p>NUP4301MR6T1G [Ⓜ] TSOP-6</p> <p>NUP4304MR6T1G [Ⓜ]</p>

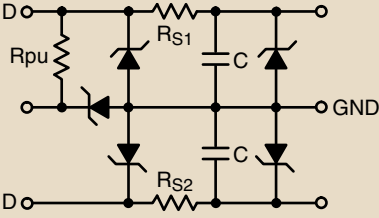
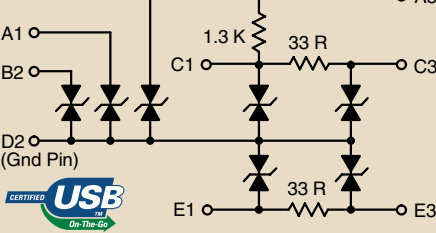
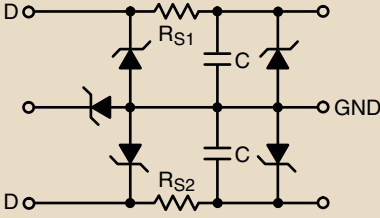

[Ⓜ] = Symbol denotes 2nd level interconnect Pb-Free (lead) content.
* = Coming soon.

USB Filter Devices

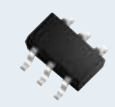
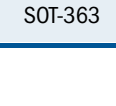
Integrated protection and termination devices for USB from ON Semiconductor can replace up to 11 devices by combining TVS diodes with resistive and capacitive elements. They are suitable for Low- and Full-Speed USB solutions. All of our devices are IEC61000-4-2 Level 4 compliant.

Upstream Filters	OTG (On-The-Go)	Upstream/Downstream Filters
		
 <p>STF202-22T1G [Ⓜ]</p> <p>TSOP-6</p>  <p>NUF2221W1T2G [Ⓜ]</p>  <p>SC-88 SOT-363</p> <p>NUF2015W1T2G [Ⓜ]</p>	 <p>Flip-Chip</p> <p>NUF2222FCT1G [Ⓜ]</p>	 <p>NUF2030XV6T1G [Ⓜ]</p> <p>30 pF (typ) @ 2.5 V</p>  <p>NUF2042XV6T1G [Ⓜ]</p> <p>42 pF (typ) @ 2.5 V</p>  <p>SC-88 SOT-363</p> <p>NUF2240W1T1G [Ⓜ]</p> <p>17 pF (typ) @ 2.5 V</p>

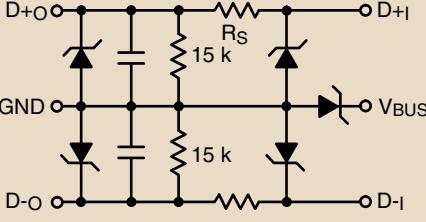
[Ⓜ] = Symbol denotes 2nd level interconnect Pb-Free (lead) content.

Downstream Filter

 <p>NUF2101MT1G [Ⓜ]</p> <p>55 pF (typ) @ 0 V</p> <p>TSOP-6</p>

[Ⓜ] = Symbol denotes 2nd level interconnect Pb-Free (lead) content.

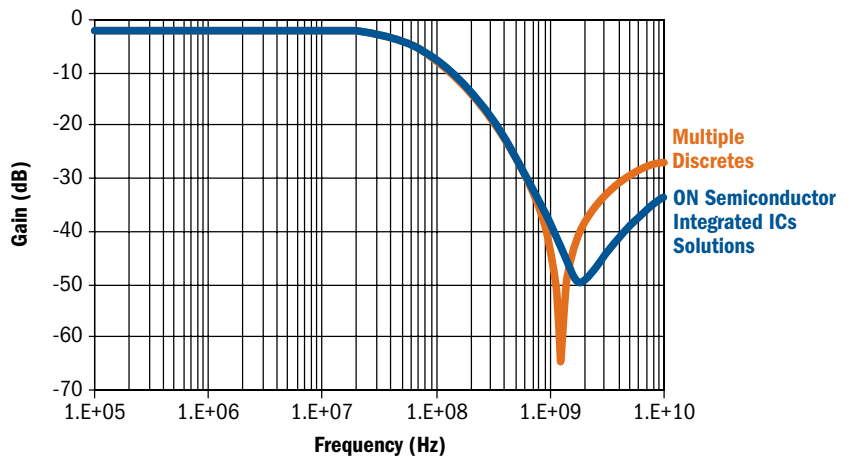
The integrated solution from ON Semiconductor delivers improved insertion losses since there are lower parasitics compared to discrete solutions which use multiple packages.

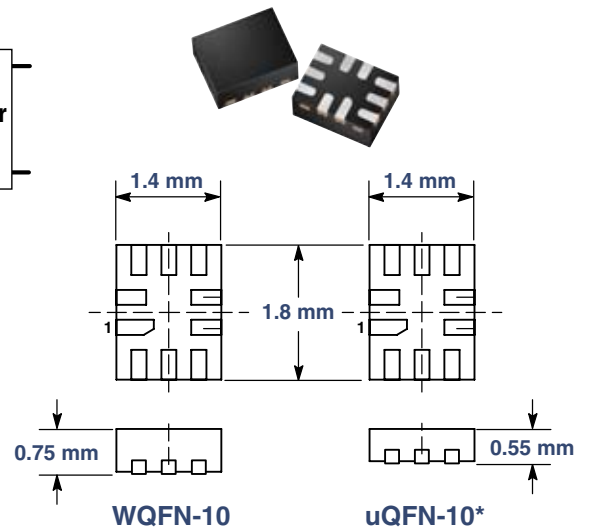
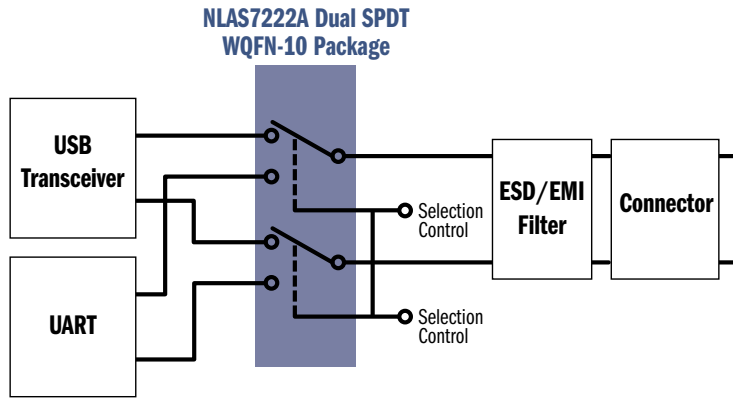

NLAS7222A Dual SPDT Switch <7 pF On Switch Capacitance



Key Performance Characteristics

- Passes USB 2.0 High Speed Signals
- 6.5 Ω Typical R_{DSon} @ 3.0 V
- 500 MHz Bandwidth
- Low Crosstalk: -45 dB @ 250 MHz
- Smallest Package in the Industry

Device	Configuration	R_{ON} Max (Ω)	C Typ (pF)	Package
NLAS7222A	Dual SPDT	9	6.5	WQFN-10, uDFN-10*
NLAS4717EP	Dual SPDT	4.5	38	Flip-Chip 10

* Coming Soon



Sales and Design Assistance from ON Semiconductor



www.onsemi.com

ON Semiconductor Distribution Partners

Arrow Electronics	www.arrow.com	(800) 777-2776
Avnet	www.em.avnet.com	(800) 332-8638
Chip Supply	www.chipsupply.com	(407) 298-7100
Digi-Key	www.digikey.com	(800) 338-1003
EBV Elektronik	www.ebv.com/en/locations.html	(49) 8121 774-0
Farnell InOne	www.farnellinone.com	+44 8701 200 200
Future Electronics Europe	www.futureelectronics.com/contact	info-eur-future@futureelectronics.com
Future & F&I Electronics	www.futureelectronics.com/contact	1-800-FUTURE1 (388-8731)
Marubun/Arrow	www.marubunarrow.com	(852) 2375-1126
Minco	www.mincotech.com	(512) 834-2022
Mouser Electronics	www.mouser.com	(800) 346-6873
Newark Electronics	www.newark.com	(800) 4-NEWARK
NuVision	www.nuvision-tech.com	(886) 2 8228-0688
Rochester Electronics	www.rocelec.com	(978) 462-9332
Semi Dice Inc	www.semidice.com	1 (800) 345-6633
Silica (An Avnet Company)	www.silica.com	+33 1 6447 2929
WPI	www.wpi-group.com	(886) 2 2788-5200
Spoerle (An Arrow Company)	www.spoerle.de/de/about/offices	+49 6103 3040

INTERNATIONAL

BRAZIL	San Paulo	(55-11) 3842-8911
GREATER CHINA	Beijing	86-10-8518-2323
	Chengdu	86-28-8678-4078
	Hong Kong	852-2689-0088
	Shenzhen	86-755-8209-1128
	Shanghai	86-21-5131-7168
	Taipei, Taiwan	886-2-2377-9911

INTERNATIONAL

FRANCE	Paris	33 (0)1 39-26-41-00
GERMANY	Munich	49 (0) 89-93-0808-0
INDIA	Bangalore	91-80-2532-5084
ISRAEL	Herzeliya	972 (0) 9-9609-111
ITALY	Milan	39 02-530-0951
JAPAN	Tokyo	81-3-5773-3850
KOREA	Seoul	82-2-2190-3500

INTERNATIONAL

MALAYSIA	Penang	60-4-226-9368
MEXICO	Guadalajara	(5233) 3123-9199
SINGAPORE	Singapore	65-6391-1260
SLOVAKIA	Piestany	421 33 790 2450
UNITED KINGDOM	Slough	44 (0) 1753 70 1676

NORTH AMERICA SALES OFFICES & REP FIRMS

Alabama	Huntsville	e-Components	(256) 533-2444
	Huntsville	ON Sales Office	(256) 774-1004
Arizona	Phoenix	Centaur Corporation	(480) 839-2320
California	Irvine	Centaur Corporation	(949) 261-2123
	Los Angeles	Centaur Corporation	(805) 579-0519
	Santa Clara	T3 Technical Sales	(408) 350-3900
	San Diego	Centaur Corporation	(858) 278-4950
CANADA	All Regions	Astec	(905) 607-1444
Colorado	Englewood	ON Sales Office	Karl Hill: (720) 895-1367 Mike Barone: (303) 670-8000
Connecticut	Monroe	Impact Technical Sales	(203) 268-7229
Florida	Boca Raton	e-Components	(561) 289-1379
	Lake Mary	e-Components	(407) 804-0042
	Plantation	ON Sales Office	(954) 325-1223
	Palm Harbor	e-Components	(727) 937-3016
	Melbourne	e-Components	(321) 676-5659
Georgia	Duluth	e-Components	(678) 380-5080
Illinois	Hoffman Estates	Stan Clothier	(847) 781-4010
Indiana	Fishers	Bear VAI	(317) 570-0707
	Kokomo	ON Sales Office	(765) 865-2091
Iowa	Cedar Rapids	Stan Clothier	(319) 393-1576
Kansas	Overland Park	Stan Clothier	(913) 894-1675
Maryland	Columbia	Third Wave Solutions	(410) 290-5990
Massachusetts	Burlington	Impact Technical Sales	(781) 238-8888
	Lowell	ON Sales Office	(978) 452-6075
Michigan	Livonia	ON Sales Office	(734) 953-6848
Minnesota	Eden Prairie	Stan Clothier	(952) 944-3456
Missouri	St. Charles	Stan Clothier	(636) 916-3777
New Jersey	Denville	CJR Associates	(973) 625-2796
New York	Long Island	CJR Associates	(973) 625-2796
	New York City	CJR Associates	(973) 625-2796
	Rochester	TriTech	(716) 385-6500
	Binghamton	TriTech	(607) 722-3580
Ohio	Brecksville	Bear VAI	(937) 748-1341
Oregon	Portland	SiFore Technical Sales	(503) 977-6267
Pennsylvania	Hatboro	Delta Technical Sales	(215) 957-0600
Texas	Austin	West Associates	(512) 343-1199
	Richardson	West Associates	(972) 680-2800
Washington	Bellevue	SiFore Technical Sales	(425) 990-4701
Wisconsin	Statewide	Stan Clothier	(847) 781-4010

ON Semiconductor and the ON logo are registered trademarks of Semiconductor Components Industries, LLC (SCILLC). SCILLC reserves the right to make changes without further notice to any products herein. SCILLC makes no warranty, representation or guarantee regarding the suitability of its products for any particular purpose, nor does SCILLC assume any liability arising out of the application or use of any product or circuit, and specifically disclaims any and all liability, including without limitation special, consequential or incidental damages. "Typical" parameters which may be provided in SCILLC data sheets and/or specifications can and do vary in different applications and actual performance may vary over time. All operating parameters, including "Typicals" must be validated for each customer application by customer's technical experts. SCILLC does not convey any license under its patent rights nor the rights of others. SCILLC products are not designed, intended, or authorized for use as components in systems intended for surgical implant into the body, or other applications intended to support or sustain life, or for any other application in which the failure of the SCILLC product could create a situation where personal injury or death may occur. Should Buyer purchase or use SCILLC products for any such unintended or unauthorized application, Buyer shall indemnify and hold SCILLC and its officers, employees, subsidiaries, affiliates, and distributors harmless against all claims, costs, damages, and expenses, and reasonable attorney fees arising out of, directly or indirectly, any claim of personal injury or death associated with such unintended or unauthorized use, even if such claim alleges that SCILLC was negligent regarding the design or manufacture of the part. SCILLC is an Equal Opportunity/Affirmative Action Employer. This literature is subject to all applicable copyright laws and is not for resale in any manner.

PUBLICATION ORDERING INFORMATION

LITERATURE FULFILLMENT:

Literature Distribution Center for ON Semiconductor
 P.O. Box 5163, Denver, Colorado 80217 USA
Phone: 303-675-2175 or 800-344-3860 Toll Free USA/Canada
Fax: 303-675-2176 or 800-344-3867 Toll Free USA/Canada
Email: orderlit@onsemi.com

N. American Technical Support: 800-282-9855 Toll Free
 USA/Canada.

Europe, Middle East and Africa Technical Support:
 Phone: 421 33 790 2910

Japan Customer Focus Center
 Phone: 81-3-5773-3850

ON Semiconductor Website: www.onsemi.com

Order Literature: <http://www.onsemi.com/orderlit>

For additional information, please contact your local
 Sales Representative