

SynQor®

MQFL-28-15D Dual Output

HIGH RELIABILITY DC/DC CONVERTER

| | | | | |
|-----------------------------------|----------------------------------|-----------------------|---------------------|--|
| 16-40V Continuous Input | 16-50V Transient Input | ±15V Output | 8A Output | 91% @ 4A / 89% @ 8A Efficiency |
|-----------------------------------|----------------------------------|-----------------------|---------------------|--|

FULL POWER OPERATION: -55°C TO +125°C

The MilQor® series of high-reliability DC/DC converters brings SynQor's field proven high-efficiency synchronous rectifier technology to the Military/Aerospace industry. SynQor's innovative QorSeal™ packaging approach ensures survivability in the most hostile environments. Compatible with the industry standard format, these converters operate at a fixed frequency, have no opto-isolators, and follow conservative component derating guidelines. They are designed and manufactured to comply with a wide range of military standards.

MilQor®



DESIGNED & MANUFACTURED IN THE USA
FEATURING QORSEAL™ HI-REL ASSEMBLY

Design Process

MQFL series converters are:

- Designed for reliability per NAVSO-P3641-A guidelines
- Designed with components derated per:
 - MIL-HDBK-1547A
 - NAVSO P-3641A

Qualification Process

MQFL series converters are qualified to:

- MIL-STD-810F
 - consistent with RTCA/DO-160E
- SynQor's First Article Qualification
 - consistent with MIL-STD-883F
- SynQor's Long-Term Storage Survivability Qualification
- SynQor's on-going life test

In-Line Manufacturing Process

- AS9100 and ISO 9001:2000 certified facility
- Full component traceability
- Temperature cycling
- Constant acceleration
- 24, 96, 160 hour burn-in
- Three level temperature screening

Features

- Fixed switching frequency
- No opto-isolators
- Parallel operation with current share
- Clock synchronization
- Primary and secondary referenced enable
- Continuous short circuit and overload protection
- Input under-voltage lockout/over-voltage shutdown

Specification Compliance

MQFL series converters (with MQME filter) are designed to meet:

- MIL-HDBK-704-8 (A through F)
- RTCA/DO-160E Section 16
- MIL-STD-1275B
- DEF-STAN 61-5 (part 6)/5
- MIL-STD-461 (C, D, E)
- RTCA/DO-160E Section 22

BLOCK DIAGRAM

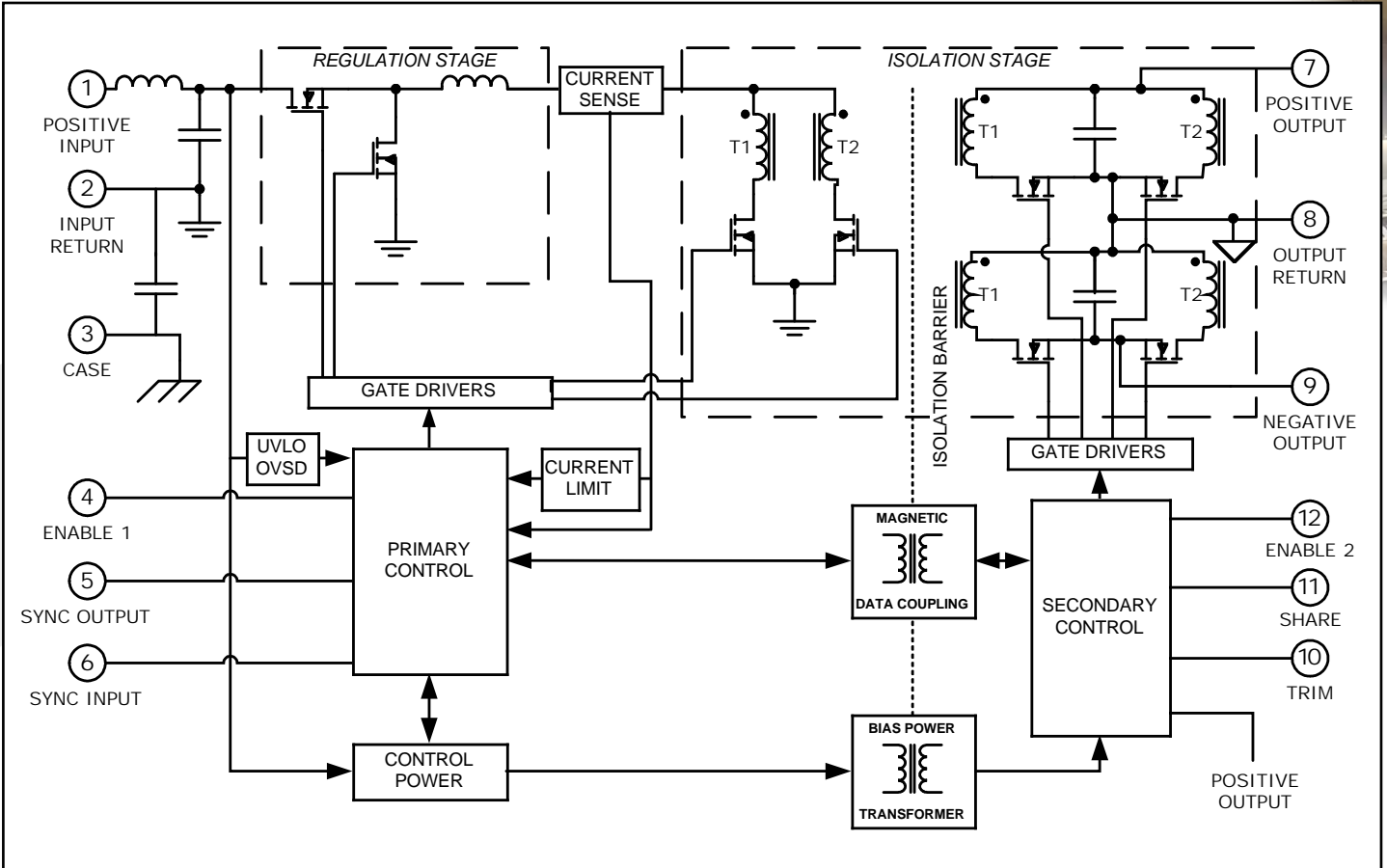

TYPICAL CONNECTION DIAGRAM

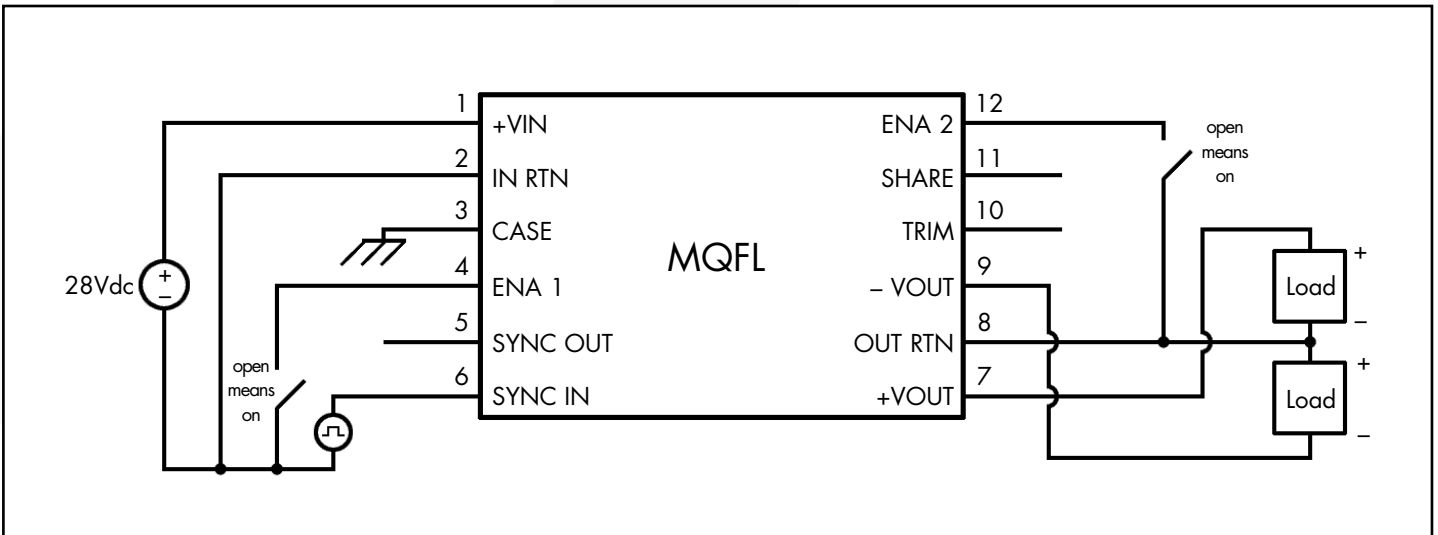



MQFL-28-15D
Output: ±15 V
Current: 8 A Total

Technical Specification

MQFL-28-15D ELECTRICAL CHARACTERISTICS

| Parameter | Min. | Nom. | Max. | Units | Notes & Conditions | Group A Subgroup ¹⁴ |
|--|--------|--------|--------|-------|--|--------------------------------|
| ABSOLUTE MAXIMUM RATINGS | | | | | | |
| Input Voltage | | | | | | |
| Non-Operating | | | 60 | V | | |
| Operating ¹ | | | 60 | V | | |
| Reverse Bias (T _{CASE} = 125°C) | | | -0.8 | V | | |
| Reverse Bias (T _{CASE} = -55°C) | | | -1.2 | V | | |
| Isolation Voltage (input/output to case, input to output) | | | | | | |
| Continuous | -500 | | 500 | V | | |
| Transient (≤100 μs) | -800 | | 800 | V | | |
| Operating Case Temperature ² | -55 | | 135 | °C | | |
| Storage Case Temperature | -65 | | 135 | °C | | |
| Lead Temperature (20 sec) | | | 300 | °C | | |
| Voltage at ENA1, ENA2, SYNC IN | -1.2 | | 50 | V | | |
| INPUT CHARACTERISTICS | | | | | | |
| Operating Input Voltage Range (continuous) | 16 | 28 | 40 | V | | 1, 2, 3 |
| Operating Input Voltage Range (transient, 1 sec) | 16 | 28 | 50 | V | | 4, 5, 6 |
| Input Under-Voltage Lockout ³ | | | | | | |
| Turn-On Voltage Threshold | 14.75 | 15.50 | 16.00 | V | | 1, 2, 3 |
| Turn-Off Voltage Threshold | 13.80 | 14.40 | 15.00 | V | | 1, 2, 3 |
| Lockout Voltage Hysteresis | 0.5 | 1.1 | 1.8 | V | | 1, 2, 3 |
| Input Over-Voltage Shutdown ³ | | | | | | |
| Turn-Off Voltage Threshold | 54.0 | 56.8 | 60.0 | V | | 1, 2, 3 |
| Turn-On Voltage Threshold | 50.0 | 51.4 | 54.0 | V | | 1, 2, 3 |
| Shutdown Voltage Hysteresis | 2.0 | 5.3 | 8.0 | V | | 1, 2, 3 |
| Maximum Input Current | | | 9.5 | A | Vin = 16V; +Iout = -Iout = 4A | 1, 2, 3 |
| No Load Input Current (operating) | | 110 | 160 | mA | | 1, 2, 3 |
| Disabled Input Current (ENA1) | | 2 | 5 | mA | Vin = 16V, 28V, 50V | 1, 2, 3 |
| Disabled Input Current (ENA2) | | 25 | 50 | mA | Vin = 16V, 28V, 50V | 1, 2, 3 |
| Input Terminal Current Ripple (peak to peak) | | 40 | 60 | mA | Bandwidth = 100 kHz - 10 MHz; see Figure 20 | 1, 2, 3 |
| OUTPUT CHARACTERISTICS | | | | | | |
| Output Voltage Set Point (T _{CASE} = 25°C) | | | | | | |
| Positive Output ¹² | +14.85 | +15.00 | +15.15 | V | | 1 |
| Negative Output ¹² | -15.15 | -15.00 | -14.85 | V | | 1 |
| Output Voltage Set Point Over Temperature | | | | | | |
| Positive Output ¹² | +14.78 | +15.00 | +15.22 | V | | 2, 3 |
| Negative Output ¹² | -15.22 | -15.00 | -14.78 | V | | 2, 3 |
| Positive Output Voltage Line Regulation ¹² | -20 | 0 | 20 | mV | Vin = 16V, 28V, 50V | 1, 2, 3 |
| Positive Output Voltage Load Regulation ¹² | 65 | 80 | 95 | mV | +Vout @ (+Iout = -Iout = 0A) - +Vout @ (+Iout = -Iout = 4A) | 1, 2, 3 |
| Total Positive Output Voltage Range ¹² | 14.70 | 15.00 | 15.30 | V | | 1, 2, 3 |
| Output Voltage Cross Regulation (Negative Output) ^{11,12} | 250 | 450 | 750 | mV | -Vout @ (+Iout = -Iout = 1.6A) - -Vout @ (+Iout = 6.4A, -Iout = 1.6A) | 1, 2, 3 |
| Output Voltage Ripple and Noise Peak to Peak | | 20 | 80 | mV | Bandwidth = 100 kHz - 10 MHz; C _L = 11 μF on both outputs | 1, 2, 3 |
| Total Operating Current Range | 0 | | 8 | A | (+Iout) + (-Iout) | 1, 2, 3 |
| Single Output Operating Current Range | 0 | | 6.4 | A | Maximum +Iout or -Iout | 1, 2, 3 |
| Operating Output Power Range | 0 | | 120 | W | Total on both outputs | 1, 2, 3 |
| Output DC Current Limit Inception ⁴ | 8.2 | 9.2 | 10.1 | A | +Iout + -Iout; +Iout = -Iout | 1, 2, 3 |
| Short Circuit Output Current | 8.8 | 9.8 | 10.8 | A | +Vout ≤ 1.2V | 1, 2, 3 |
| Back-Drive Current Limit while Enabled | | 2.5 | | A | | 1, 2, 3 |
| Back-Drive Current Limit while Disabled | | 10 | 50 | mA | | 1, 2, 3 |
| Maximum Output Capacitance ⁵ | | | 3000 | μF | Total on both outputs | See Note 5 |
| DYNAMIC CHARACTERISTICS | | | | | | |
| Output Voltage Deviation Load Transient ⁶ | | | | | | |
| For a Positive Step Change in Load Current | -500 | -300 | | mV | Total Iout Step = 4A ↔ 8A, 0.8A ↔ 4A; C _L = 11 μF on both outputs | 4, 5, 6 |
| For a Negative Step Change in Load Current | | 300 | 500 | mV | " | 4, 5, 6 |
| Settling Time (either case) ⁷ | | 50 | 200 | μs | | 4, 5, 6 |
| Output Voltage Deviation Line Transient ⁸ | | | | | | |
| For a Positive Step Change in Line Voltage | -500 | | 500 | mV | Vin step = 16V ↔ 50V; C _L = 11 μF on both outputs | 4, 5, 6 |
| For a Negative Step Change in Line Voltage | -500 | | 500 | mV | " | 4, 5, 6 |
| Settling Time (either case) ⁷ | | 250 | 500 | μs | | See Note 5 |
| Turn-On Transient | | | | | | |
| Output Voltage Rise Time | | 6 | 10 | ms | +Vout = 1.5V → 13.5V | 4, 5, 6 |
| Output Voltage Overshoot | | 0 | 2 | % | | See Note 5 |
| Turn-On Delay, Rising Vin ⁹ | | 5.5 | 8.0 | ms | ENA1, ENA2 = 5V | 4, 5, 6 |
| Turn-On Delay, Rising ENA1 | | 3.0 | 6.0 | ms | ENA2 = 5V | 4, 5, 6 |
| Turn-On Delay, Rising ENA2 | | 1.5 | 3.0 | ms | ENA1 = 5V | 4, 5, 6 |



MQFL-28-15D
Output: ±15 V
Current: 8 A Total

Technical Specification

MQFL-28-15D ELECTRICAL CHARACTERISTICS (Continued)

| Parameter | Min. | Nom. | Max. | Units | Notes & Conditions Vin=28V DC ±5%, +Iout = -Iout = 4A, CL = 0 µF, free running ¹⁰ unless otherwise specified | Group A Subgroup ¹⁴ |
|---|------|------|------|----------------------|---|-----------------------------------|
| EFFICIENCY | | | | | | |
| Iout = 8A (16Vin) | 85 | 90 | | % | | 1, 2, 3 |
| Iout = 4A (16Vin) | 87 | 92 | | % | | 1, 2, 3 |
| Iout = 8A (28Vin) | 85 | 89 | | % | | 1, 2, 3 |
| Iout = 4A (28Vin) | 87 | 91 | | % | | 1, 2, 3 |
| Iout = 8A (40Vin) | 84 | 88 | | % | | 1, 2, 3 |
| Iout = 4A (40Vin) | 86 | 90 | | % | | 1, 2, 3 |
| Load Fault Power Dissipation | | 16 | 32 | W | Iout at current limit inception point ⁴ | 1, 2, 3 |
| Short Circuit Power Dissipation | | 20 | 33 | W | +Vout ≤ +1.2V; -Vout ≥ -1.2V | 1, 2, 3 |
| ISOLATION CHARACTERISTICS | | | | | | |
| Isolation Voltage (dielectric strength) | | | | | | |
| Input RTN to Output RTN | 500 | | | V | | 1 |
| Any Input Pin to Case | 500 | | | V | | 1 |
| Any Output Pin to Case | 500 | | | V | | 1 |
| Isolation Resistance (input rtn to output rtn) | 100 | | | MΩ | | 1 |
| Isolation Resistance (any pin to case) | 100 | | | MΩ | | 1 |
| Isolation Capacitance (input rtn to output rtn) | | 44 | | nF | | 1 |
| FEATURE CHARACTERISTICS | | | | | | |
| Switching Frequency (free running) | 500 | 550 | 600 | kHz | | 1, 2, 3 |
| Synchronization Input | | | | | | |
| Frequency Range | 500 | | 700 | kHz | | 1, 2, 3 |
| Logic Level High | 2 | | 10 | V | | 1, 2, 3 |
| Logic Level Low | -0.5 | | 0.8 | V | | 1, 2, 3 |
| Duty Cycle | 20 | | 80 | % | | See Note 5 |
| Synchronization Output | | | | | | |
| Pull Down Current | 20 | | | mA | VSYNC OUT = 0.8V | See Note 5 |
| Duty Cycle | 25 | | 75 | % | Output connected to SYNC IN of another MQFL converter | See Note 5 |
| Enable Control (ENA1 and ENA2) | | | | | | |
| Off-State Voltage | | | 0.8 | V | | 1, 2, 3 |
| Module Off Pulldown Current | 80 | | | µA | Current drain required to ensure module is off | See Note 5 |
| On-State Voltage | 2 | | | V | | 1, 2, 3 |
| Module On Pin Leakage Current | | | 20 | µA | Maximum current draw from pin allowed with module still on | See Note 5 |
| Pull-Up Voltage | 3.2 | 4.0 | 4.5 | V | See Figure A | 1, 2, 3 |
| Output Voltage Trim Range | -2.0 | | 0.5 | V | (+Vout) - 15V; See Figure E | See Note 5 |
| RELIABILITY CHARACTERISTICS | | | | | | |
| Calculated MTBF (MIL-STD-217F2) | | | | | | |
| GB @ Tcase=70°C | | 2800 | | 10 ³ Hrs. | | |
| AIF @ Tcase=70°C | | 420 | | 10 ³ Hrs. | | |
| Demonstrated MTBF | | TBD | | 10 ³ Hrs. | | |
| WEIGHT CHARACTERISTICS | | | | | | |
| Device Weight | | 79 | | g | | |

Electrical Characteristics Notes

1. Converter will undergo input over-voltage shutdown.
2. Derate output power to 50% of rated power at Tcase = 135° C.
3. High or low state of input voltage must persist for about 200µs to be acted on by the lockout or shutdown circuitry.
4. Current limit inception is defined as the point where the output voltage has dropped to 90% of its nominal value.
5. Parameter not tested but guaranteed to the limit specified.
6. Load current transition time ≥ 10µs.
7. Settling time measured from start of transient to the point where the output voltage has returned to ±1% of its final value.
8. Line voltage transition time ≥ 100µs.
9. Input voltage rise time ≤ 250µs.
10. Operating the converter at a synchronization frequency above the free running frequency will cause the converter's efficiency to be slightly reduced and it may also cause a slight reduction in the maximum output current/power available. For more information consult the factory.
11. The regulation stage operates to control the positive output. The negative output displays cross regulation.
12. All +Vout and -Vout voltage measurements are made with Kelvin probes on the output leads.
13. SHARE pin outputs a power failure warning pulse during a fault condition. See Current Share section on page 12.
14. Only the ES and HB grade products are tested at three temperatures. The B and C grade products are tested at one temperature. Please refer to the ESS table on Page 15 for details.
15. These derating curves apply for the ES- and HB- grade products. The C- grade product has a maximum case temperature of 100° C and a maximum junction temperature rise of 20° C above T_{CASE}. The B- grade product has a maximum case temperature of 85° C and a maximum junction temperature rise of 20° C at full load.



Technical Specification

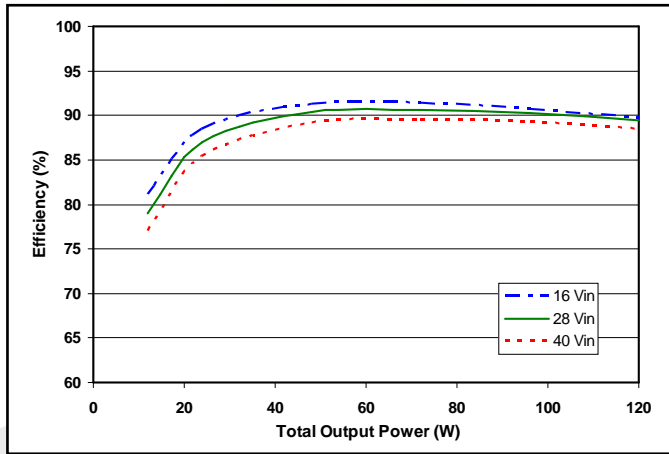

Figure 1: Efficiency vs. output power, from 0 load to full load with 50% load on the +15V output and 50% load on the -15V output at minimum, nominal, and maximum input voltage at 25°C.

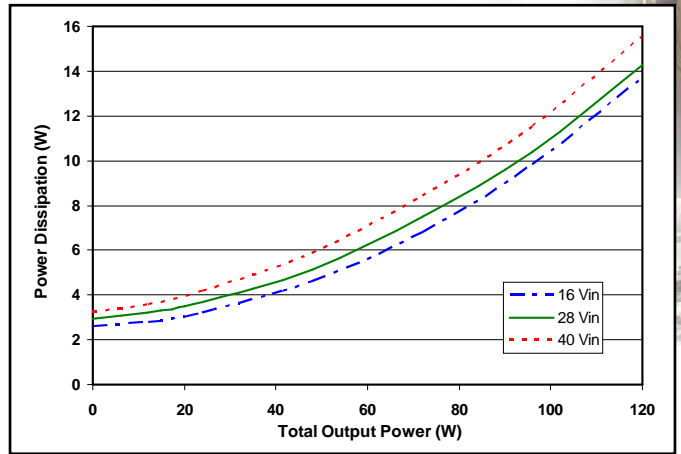

Figure 2: Power dissipation vs. output power, from 0 load to full load with 50% load on the +15V output and 50% load on the -15V output at minimum, nominal, and maximum input voltage at 25°C.

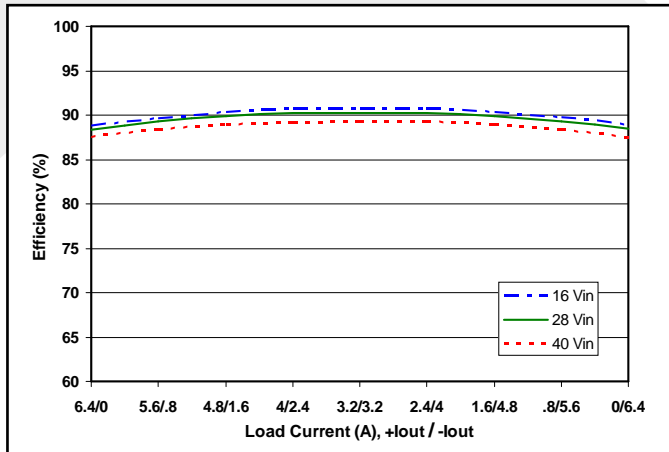

Figure 3: Efficiency vs. output current, with total output current fixed at 80% load (96W) and loads split as shown between the +15V and -15V outputs at minimum, nominal, and maximum input voltage at 25°C.

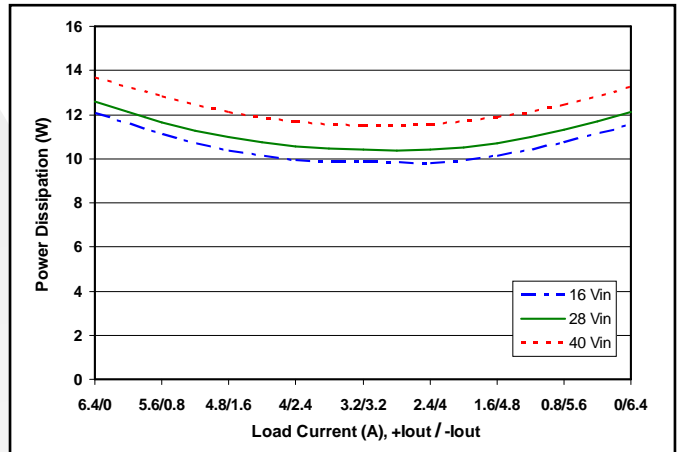

Figure 4: Power dissipation vs. output current, with total output current fixed at 80% load (96W) and loads split as shown between the +15V and -15V outputs at minimum, nominal, and max input voltage at 25°C.

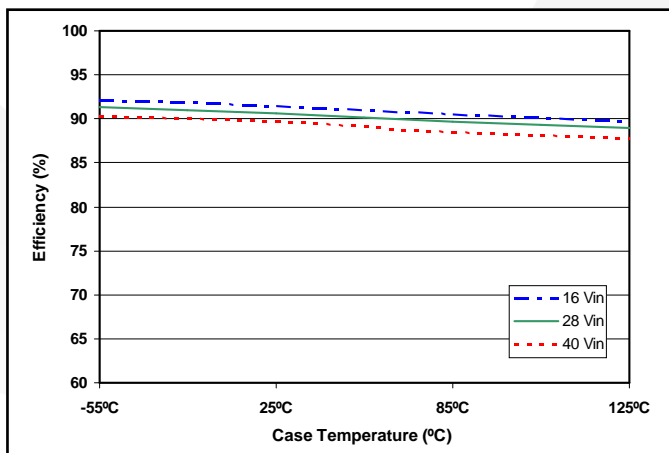

Figure 5: Efficiency at 60% load (2.4A load on +15V and 2.4A load on -15V) versus case temperature for Vin = 16V, 28V, and 40V.

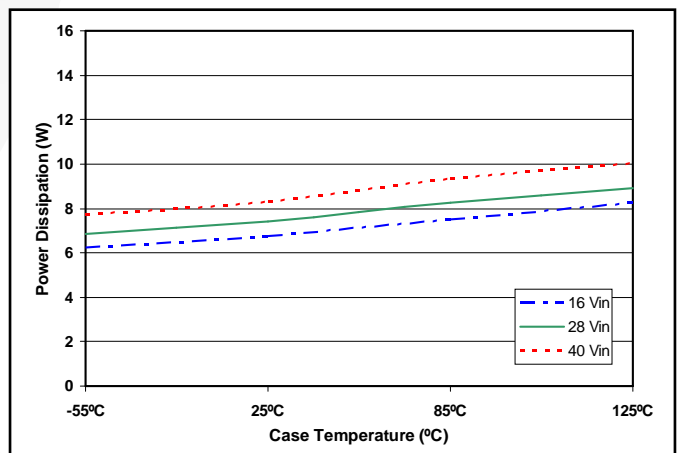

Figure 6: Power dissipation at 60% load (2.4A load on +15V and 2.4A load on -15V) versus case temperature for Vin = 16V, 28V, and 40V.

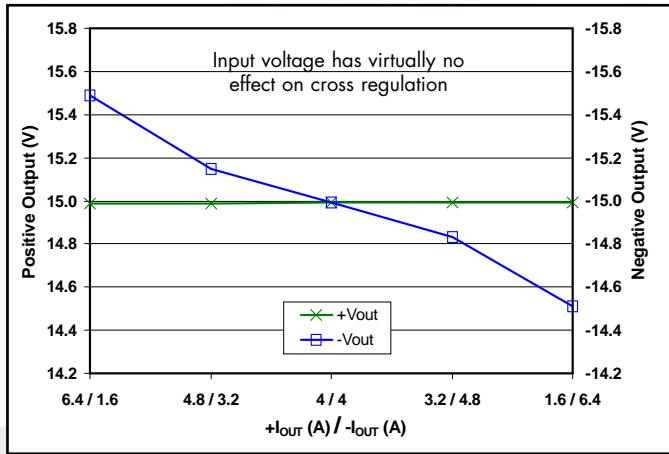

Figure 7: Load regulation vs. load current with power fixed at full load (120W) and load currents split as shown between the +15V and -15V outputs, at nominal input voltage and $T_{CASE} = 25^{\circ}C$.

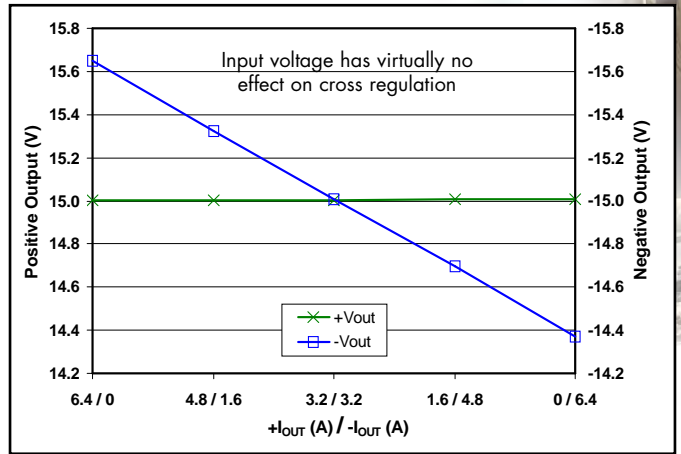

Figure 8: Load regulation vs. load current with power fixed at 80% load (96W) and load currents split as shown between the +15V and -15V outputs, at nominal input voltage and $T_{CASE} = 25^{\circ}C$.

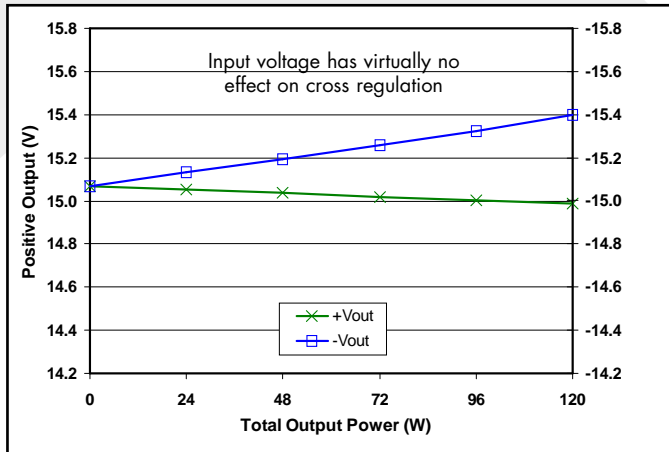

Figure 9: Load regulation vs. total output power from zero to full load where +I_{out} equals three times -I_{out} at nominal input voltage and $T_{CASE} = 25^{\circ}C$.

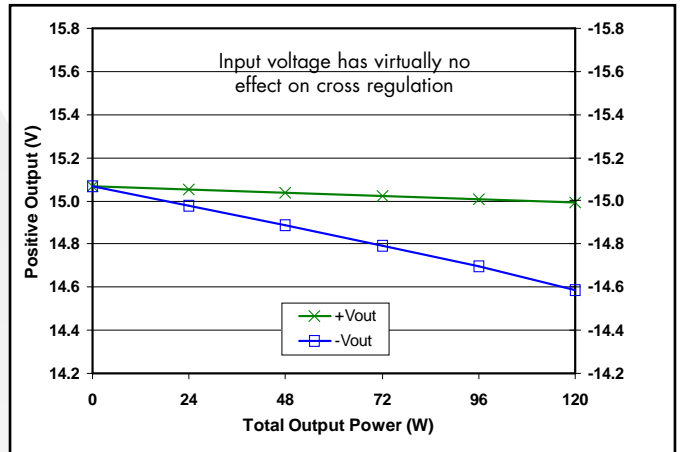

Figure 10: Load regulation vs. total output power from zero to full load where -I_{out} equals three times +I_{out} at nominal input voltage and $T_{CASE} = 25^{\circ}C$.

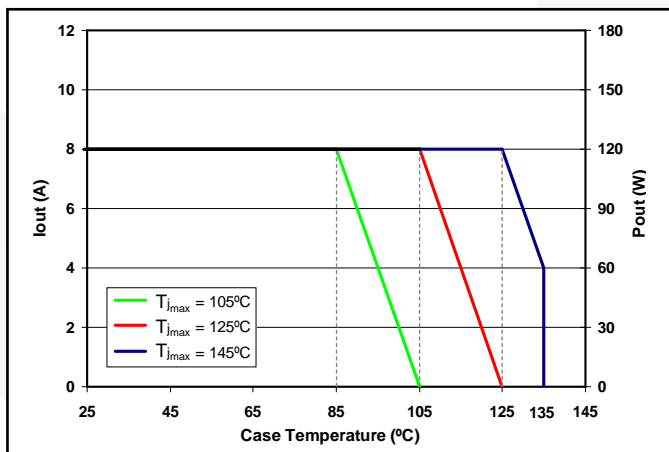

Figure 11: Output Current / Output Power derating curve as a function of T_{CASE} and the maximum desired power MOSFET junction temperature (see Note 15).

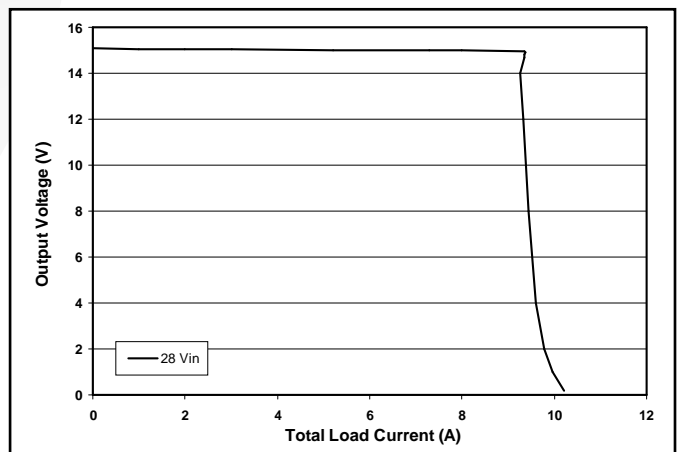

Figure 12: Positive output voltage vs. total load current evenly split showing typical current limit curves.

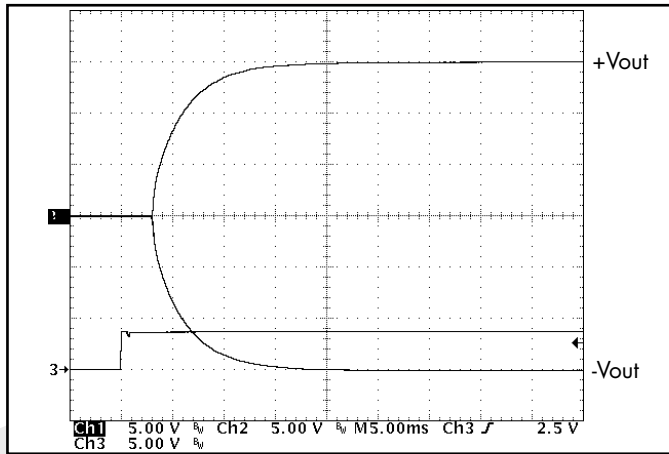

Figure 13: Turn-on transient at full rated load current (resistive load) (5 ms/div). Input voltage pre-applied. Ch 1: +Vout (5V/div); Ch 2: -Vout (5V/div); Ch 3: Enable1 input (5V/div).

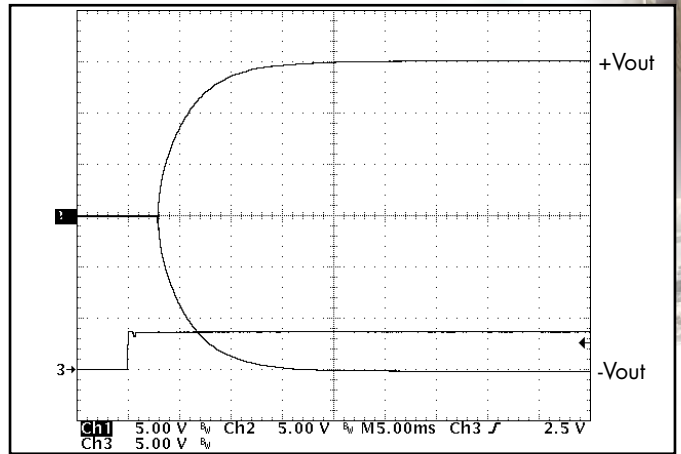

Figure 14: Turn-on transient at zero load current (5 ms/div). Input voltage pre-applied. Ch 1: +Vout (5V/div); Ch 2: -Vout (5V/div); Ch 3: Enable1 input (5V/div).

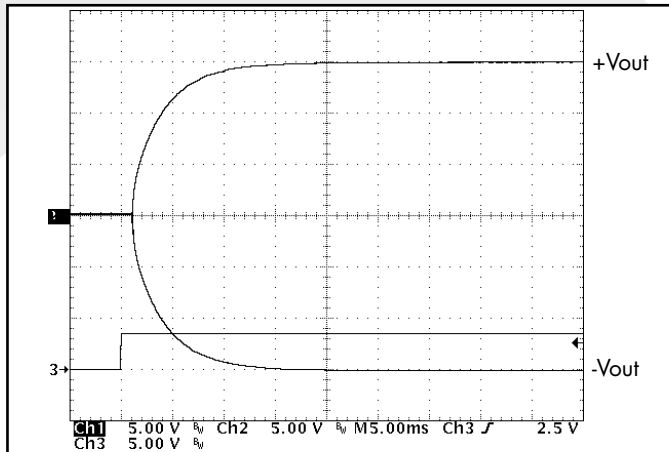

Figure 15: Turn-on transient at full rated load current (resistive load) (5 ms/div). Input voltage pre-applied. Ch 1: +Vout (5V/div); Ch 2: -Vout (5V/div); Ch 3: Enable2 input (5V/div).

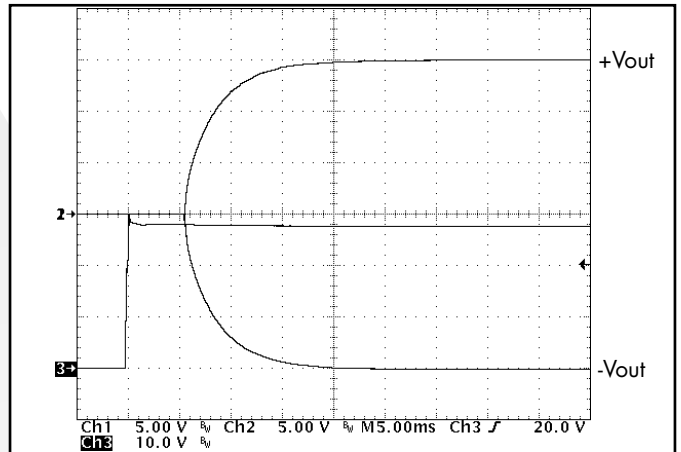

Figure 16: Turn-on transient at full load, after application of input voltage (ENA 1 and ENA 2 logic high) (5 ms/div). Ch 1: +Vout (5V/div); Ch 2: -Vout (5V/div); Ch 3: Vin (10V/div).

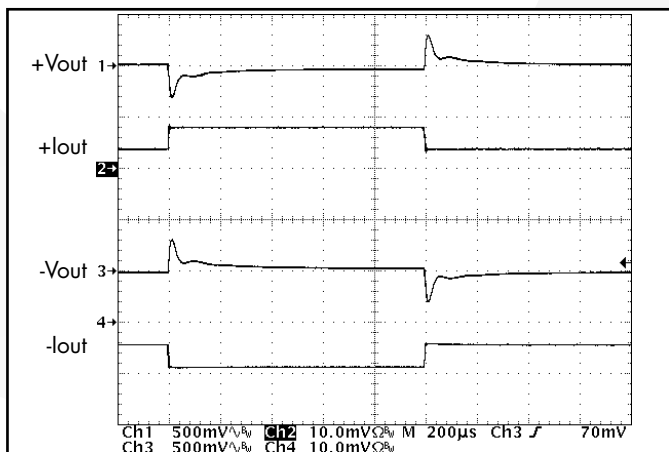

Figure 17: Output voltage response to step-change in total load current (50%-100%-50%) of total Iout (max) split 50%/50%. Load cap: 1µF ceramic cap and 10µF, 100 mΩ ESR tantalum cap. Ch 1: +Vout (500mV/div); Ch 2: -Iout (5A/div); Ch 3: -Vout (500mV/div); Ch 4: -Iout (5A/div).

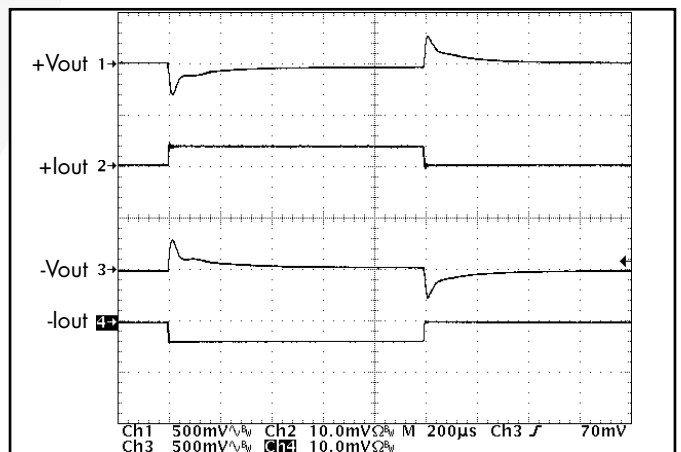

Figure 18: Output voltage response to step-change in total load current (0%-50%-0%) of total Iout (max) split 50%/50%. Load cap: 1µF ceramic cap and 10µF, 100 mΩ ESR tantalum cap. Ch 1: +Vout (500mV/div); Ch 2: -Iout (5A/div); Ch 4: -Vout (500mV/div); Ch 4: -Iout (5A/div).

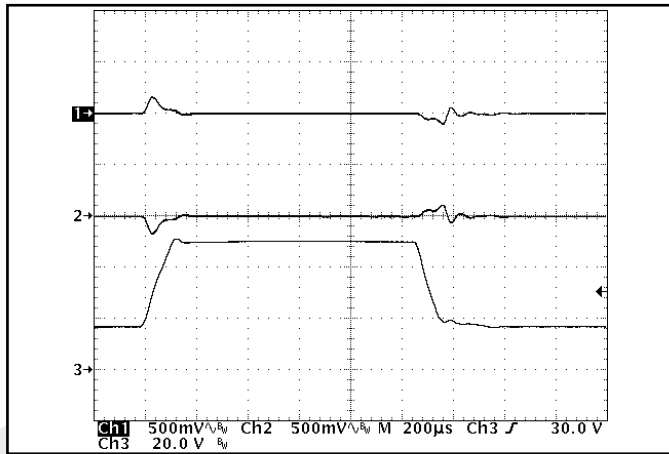

Figure 19: Output voltage response to step-change in input voltage (16V - 50V - 16V). Load cap: 10 μ F, 100 m Ω ESR tantalum cap and 1 μ F ceramic cap. Ch 1: +Vout (500mV/div); Ch 2: -Vout (500mV/div); Ch 3: Vin (20V/div).

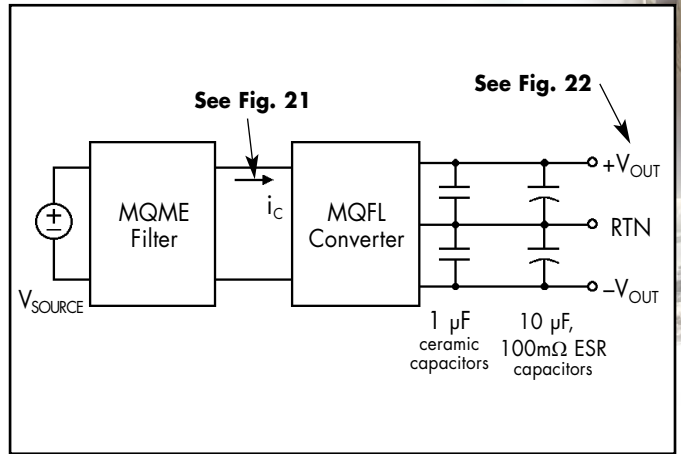

Figure 20: Test set-up diagram showing measurement points for Input Terminal Ripple Current (Figure 21) and Output Voltage Ripple (Figure 22).

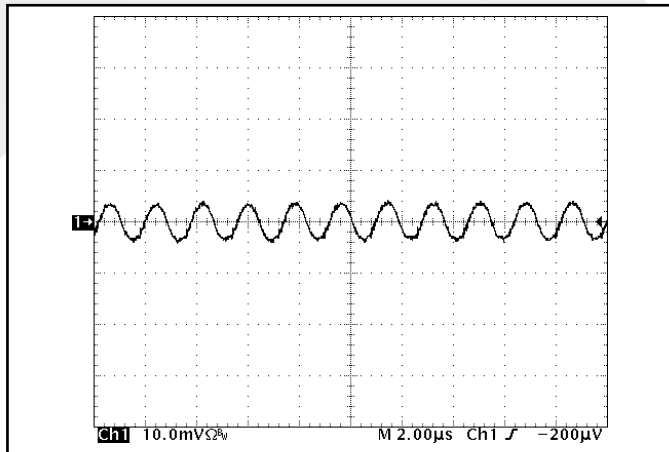

Figure 21: Input terminal current ripple, i_c , at full rated output current and nominal input voltage with SynQor MQ filter module (50 mA/div). Bandwidth: 20MHz. See Figure 20.

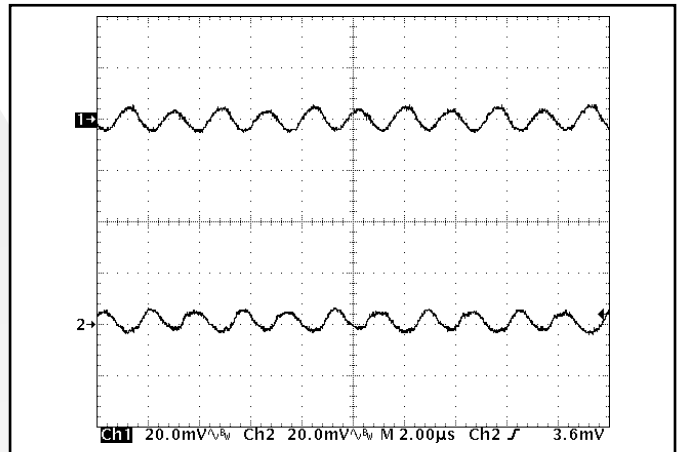

Figure 22: Output voltage ripple, +Vout (Ch 1) and -Vout (Ch 2), at nominal input voltage and full load current evenly split (20 mV/div). Load capacitance: 1 μ F ceramic cap and 10 μ F tantalum cap. Bandwidth: 10 MHz. See Figure 20.

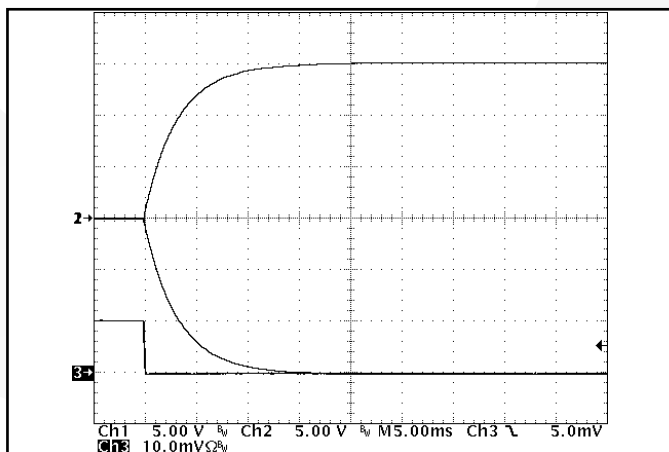

Figure 23: Rise of output voltage after the removal of a short circuit across the positive output terminals. Ch 1: +Vout (5V/div); Ch 2: -Vout (5V/div); Ch 3: +Iout (10A/div).

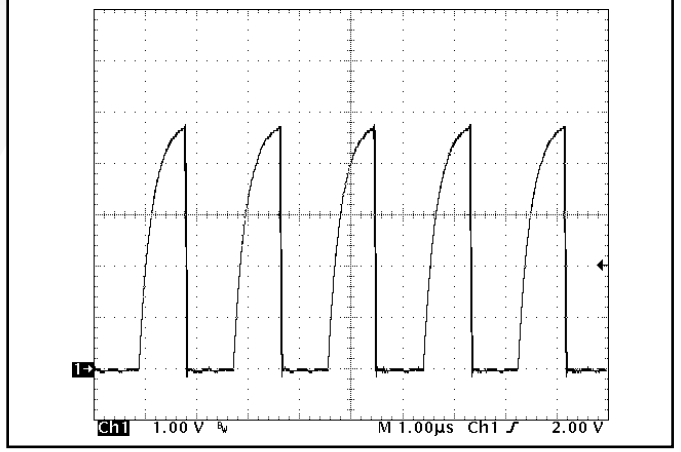

Figure 24: SYNC OUT vs. time, driving SYNC IN of a second SynQor MQFL converter.

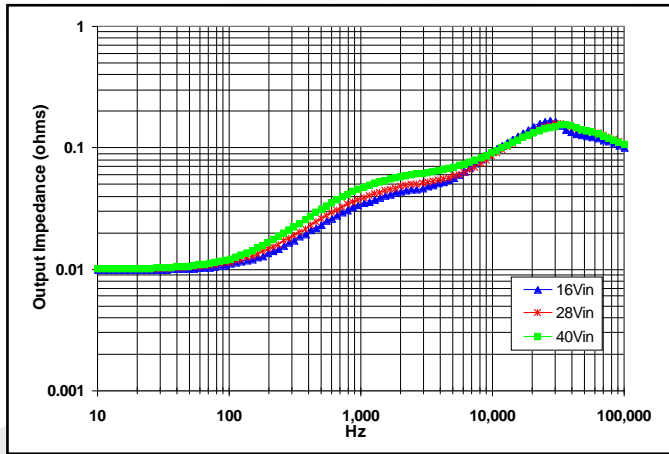

Figure 25: Magnitude of incremental output impedance ($+Z_{out} = +v_{out}/i_{out}$) for minimum, nominal, and maximum input voltage at full rated power.

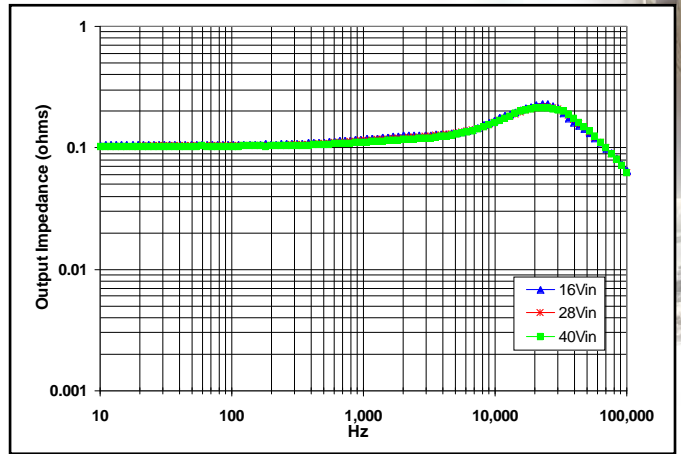

Figure 26: Magnitude of incremental output impedance ($-Z_{out} = -v_{out}/-i_{out}$) for minimum, nominal, and maximum input voltage at full rated power.

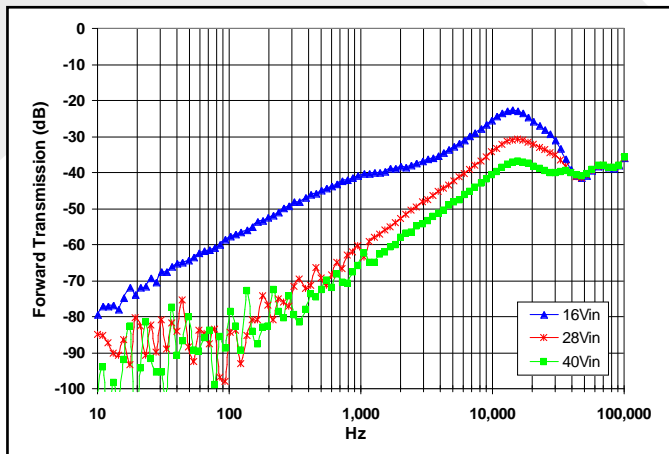

Figure 27: Magnitude of incremental forward transmission ($+FT = +v_{out}/v_{in}$) for minimum, nominal, and maximum input voltage at full rated power.

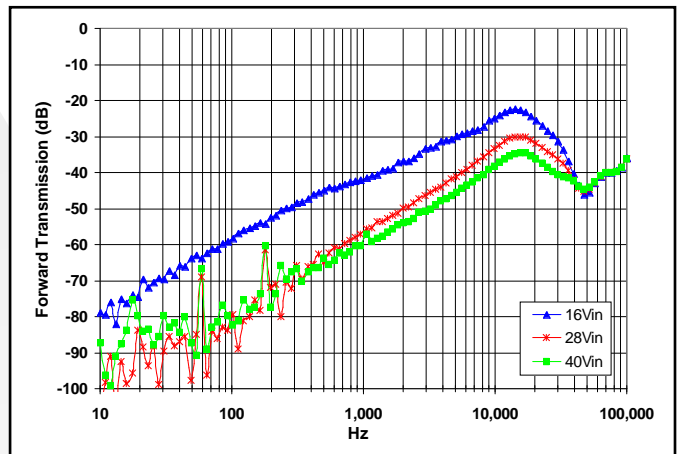

Figure 28: Magnitude of incremental forward transmission ($-FT = -v_{out}/v_{in}$) for minimum, nominal, and maximum input voltage at full rated power.

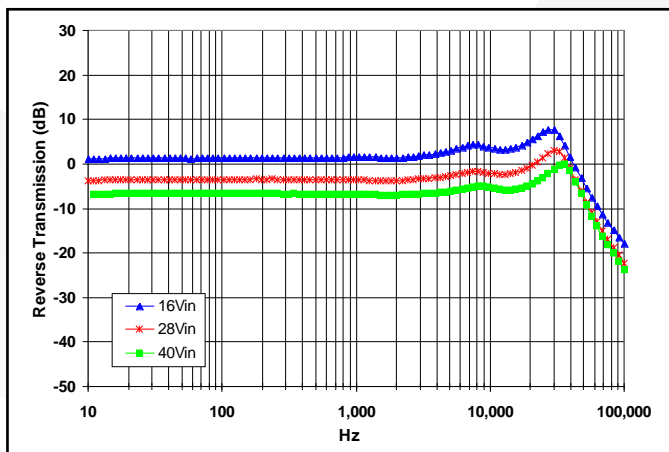

Figure 29: Magnitude of incremental reverse transmission ($+RT = i_{in}/+i_{out}$) for minimum, nominal, and maximum input voltage at full rated power.

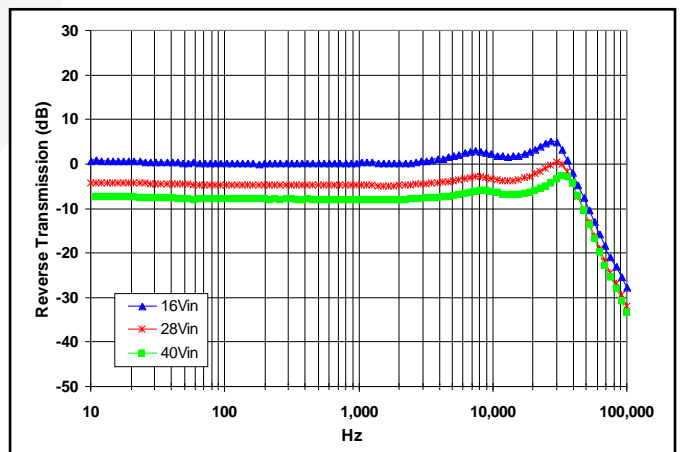

Figure 30: Magnitude of incremental reverse transmission ($-RT = i_{in}/-i_{out}$) for minimum, nominal, and maximum input voltage at full rated power.

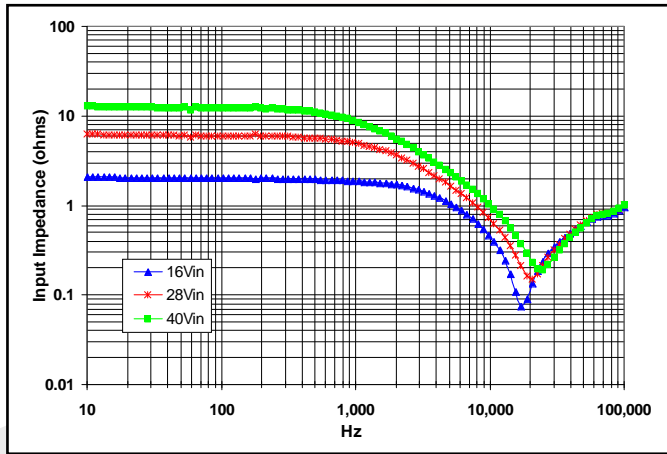

Figure 31: Magnitude of incremental input impedance ($Z_{in} = v_{in}/i_{in}$) for minimum, nominal, and maximum input voltage at full rated power with 50% / 50% split.

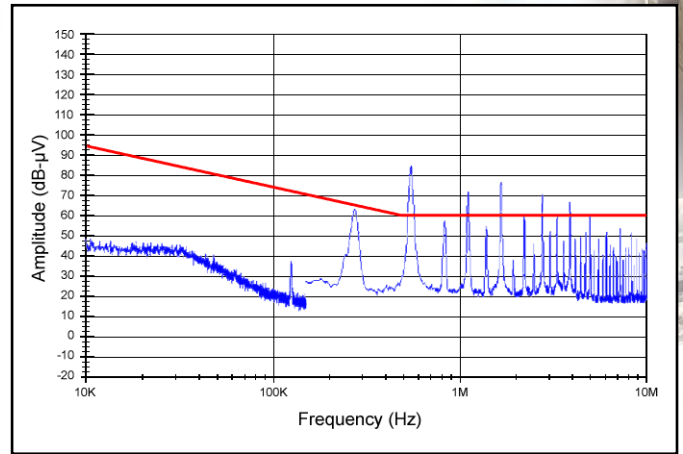

Figure 32: High frequency conducted emissions of standalone MQFL-28-05S, 5Vout module at 120W output, as measured with Method CE102. Limit line shown is the 'Basic Curve' for all applications with a 28V source.

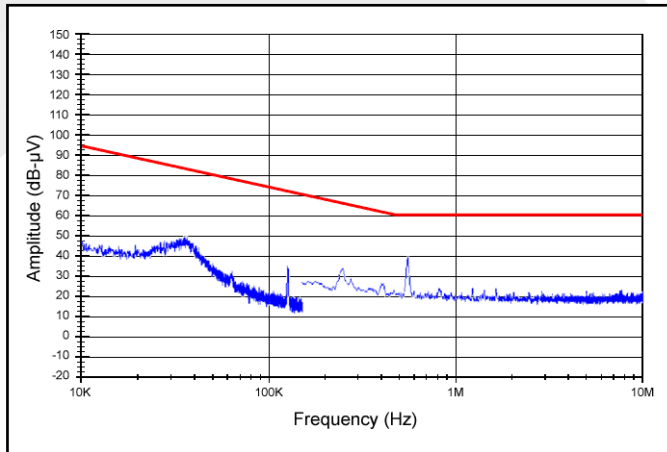

Figure 33: High frequency conducted emissions of MQFL-28-05S, 5Vout module at 120W output with MQFL-28-P filter, as measured with Method CE102. Limit line shown is the 'Basic Curve' for all applications with a 28V source.

BASIC OPERATION AND FEATURES

The MQFL DC/DC converter uses a two-stage power conversion topology. The first, or regulation, stage is a buck-converter that keeps the output voltage constant over variations in line, load, and temperature. The second, or isolation, stage uses transformers to provide the functions of input/output isolation and voltage transformation to achieve the output voltage required.

In the dual output converter there are two secondary windings in the transformer of the isolation stage, one for each output. There is only one regulation stage, however, and it is used to control the positive output. The negative output therefore displays "Cross-Regulation", meaning that its output voltage depends on how much current is drawn from each output.

Both the positive and the negative outputs share a common OUTPUT RETURN pin.

Both the regulation and the isolation stages switch at a fixed frequency for predictable EMI performance. The isolation stage switches at one half the frequency of the regulation stage, but due to the push-pull nature of this stage it creates a ripple at double its switching frequency. As a result, both the input and the output of the converter have a fundamental ripple frequency of about 550 kHz in the free-running mode.

Rectification of the isolation stage's output is accomplished with synchronous rectifiers. These devices, which are MOSFETs with a very low resistance, dissipate far less energy than would Schottky diodes. This is the primary reason why the MQFL converters have such high efficiency, particularly at low output voltages.

Besides improving efficiency, the synchronous rectifiers permit operation down to zero load current. There is no longer a need for a minimum load, as is typical for converters that use diodes for rectification. The synchronous rectifiers actually permit a negative load current to flow back into the converter's output terminals if the load is a source of short or long term energy. The MQFL converters employ a "back-drive current limit" to keep this negative output terminal current small.

There is a control circuit on both the input and output sides of the MQFL converter that determines the conduction state of the power switches. These circuits communicate with each other across the isolation barrier through a magnetically coupled device. No opto-isolators are used.

A separate bias supply provides power to both the input and output control circuits. Among other things, this bias supply permits

the converter to operate indefinitely into a short circuit and to avoid a hiccup mode, even under a tough start-up condition.

An input under-voltage lockout feature with hysteresis is provided, as well as an input over-voltage shutdown. There is also an output current limit that is nearly constant as the load impedance decreases to a short circuit (i.e., there is not fold-back or fold-forward characteristic to the output current under this condition). When a load fault is removed, the output voltage rises exponentially to its nominal value without an overshoot.

The MQFL converter's control circuit does not implement an output over-voltage limit or an over-temperature shutdown.

The following sections describe the use and operation of additional control features provided by the MQFL converter.

CONTROL FEATURES

ENABLE: The MQFL converter has two enable pins. Both must have a logic high level for the converter to be enabled. A logic low on either pin will inhibit the converter.

The ENA1 pin (pin 4) is referenced with respect to the converter's input return (pin 2). The ENA2 pin (pin 12) is referenced with respect to the converter's output return (pin 8). This permits the converter to be inhibited from either the input or the output side.

Regardless of which pin is used to inhibit the converter, the regulation and the isolation stages are turned off. However, when the converter is inhibited through the ENA1 pin, the bias supply is also turned off, whereas this supply remains on when the converter is inhibited through the ENA2 pin. A higher input standby current therefore results in the latter case.

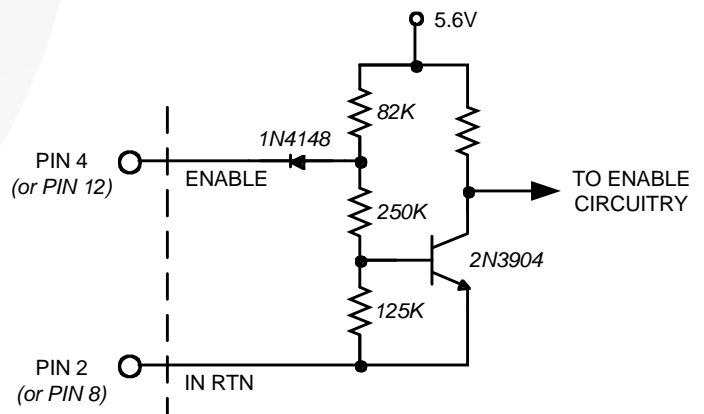

Figure A: Equivalent circuit looking into either the ENA1 or ENA2 pins with respect to its corresponding return pin.

Both enable pins are internally pulled high so that an open connection on both pins will enable the converter. Figure A shows the equivalent circuit looking into either enable pins. It is TTL compatible.

SYNCHRONIZATION: The MQFL converter's switching frequency can be synchronized to an external frequency source that is in the 500 kHz to 700 kHz range. A pulse train at the desired frequency should be applied to the SYNC IN pin (pin 6) with respect to the INPUT RETURN (pin 2). This pulse train should have a duty cycle in the 20% to 80% range. Its low value should be below 0.8V to be guaranteed to be interpreted as a logic low, and its high value should be above 2.0V to be guaranteed to be interpreted as a logic high. The transition time between the two states should be less than 300ns.

If the MQFL converter is not to be synchronized, the SYNC IN pin should be left open circuit. The converter will then operate in its free-running mode at a frequency of approximately 550 kHz.

If, due to a fault, the SYNC IN pin is held in either a logic low or logic high state continuously, the MQFL converter will revert to its free-running frequency.

The MQFL converter also has a SYNC OUT pin (pin 5). This out-

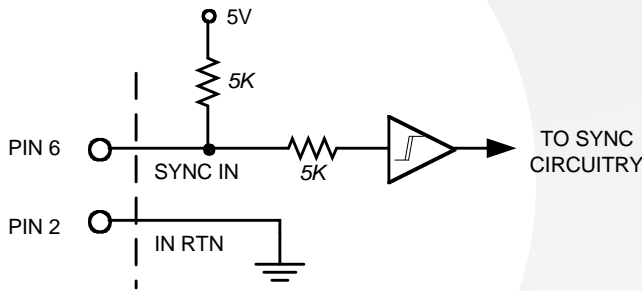

Figure B: Equivalent circuit looking into the SYNC IN pin with respect to the IN RTN (input return) pin.

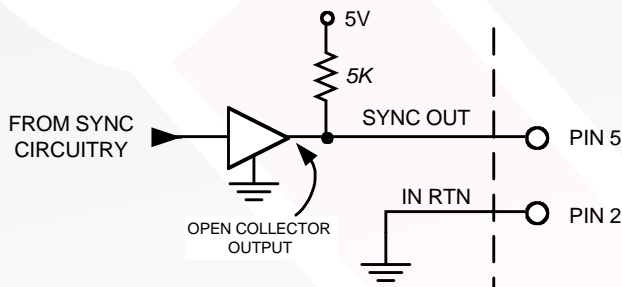

Figure C: Equivalent circuit looking into SYNC OUT pin with respect to the IN RTN (input return) pin.

put can be used to drive the SYNC IN pins of as many as ten (10) other MQFL converters. The pulse train coming out of SYNC OUT has a duty cycle of 50% and a frequency that matches the switching frequency of the converter with which it is associated. This frequency is either the free-running frequency if there is no synchronization signal at the SYNC IN pin, or the synchronization frequency if there is.

The SYNC OUT signal is available only when the dc input voltage is above approximately 12V and when the converter is not inhibited through the ENA1 pin. An inhibit through the ENA2 pin will not turn the SYNC OUT signal off.

NOTE: An MQFL converter that has its SYNC IN pin driven by the SYNC OUT pin of a second MQFL converter will have its start of its switching cycle delayed approximately 180 degrees relative to that of the second converter.

Figure B shows the equivalent circuit looking into the SYNC IN pin. Figure C shows the equivalent circuit looking into the SYNC OUT pin.

CURRENT SHARE: Like the single output MQFL converters, the dual output converters have a SHARE pin (pin 11). In this case, however, the voltage at this pin represents the sum of the positive and negative output currents. As such, the share pin cannot cause two or more paralleled converters to share load currents on the positive or negative outputs independently. Nevertheless, there may be applications where the two currents have a fixed ratio, in which case it can make sense to force the sharing of total current among several converters.

Since the SHARE pin is monitored with respect to the OUTPUT RETURN (pin 8) by each converter, it is important to connect all of the converters' OUTPUT RETURN pins together through a low DC and AC impedance. When this is done correctly, the converters will deliver their appropriate fraction of the total load current to within +/- 10% at full rated load.

Whether or not converters are paralleled, the voltage at the SHARE pin could be used to monitor the approximate average current delivered by the converter(s). A nominal voltage of 1.0V represents zero current and a nominal voltage of 2.2V represents the maximum rated total current, with a linear relationship in between. The internal source resistance of a converter's SHARE pin signal is 2.5 kΩ. During an input voltage fault or primary disable event, the SHARE pin outputs a power failure warning pulse. The SHARE pin will go to 3V for approximately 14ms as the output voltage falls.

NOTE: Converters operating from separate input filters with reverse polarity protection (such as the MQME-28-T filter) with

their outputs connected in parallel may exhibit hiccup operation at light loads. Consult factory for details.

OUTPUT VOLTAGE TRIM: If desired, it is possible to increase or decrease the MQFL dual converter's output voltage from its nominal value. To increase the output voltage a resistor, R_{up} , should be connected between the TRIM pin (pin 10) and the OUTPUT RETURN pin (pin 8), as shown in Figure D. The value of this resistor should be determined according to the following equation:

$$R_{up} = 10 \times \left(\frac{V_{nom} - 2.5}{V_{out} - V_{nom}} - 2 \times V_{nom} + 5 \right)$$

where:

V_{nom} = the converter's nominal output voltage,
 V_{out} = the desired output voltage (greater than V_{nom}), and
 R_{up} is in kiloOhms ($k\Omega$).

The maximum value of output voltage that can be achieved is 15.5V.

To decrease the output voltage a resistor, R_{down} , should be connected between the TRIM pin and the POSITIVE OUTPUT pin (pin 7), as shown in Figure D. The value of this resistor should be determined according to the following equation:

$$R_{down} = 10 \times \left[\frac{V_{nom}}{2.5} - 1 \right] \times \left[\frac{V_{out} - 2.5}{V_{nom} - V_{out}} - 5 \right]$$

where:

V_{nom} = the converter's nominal output voltage,
 V_{out} = the desired output voltage (less than V_{nom}), and
 R_{down} is in kiloOhms ($k\Omega$).

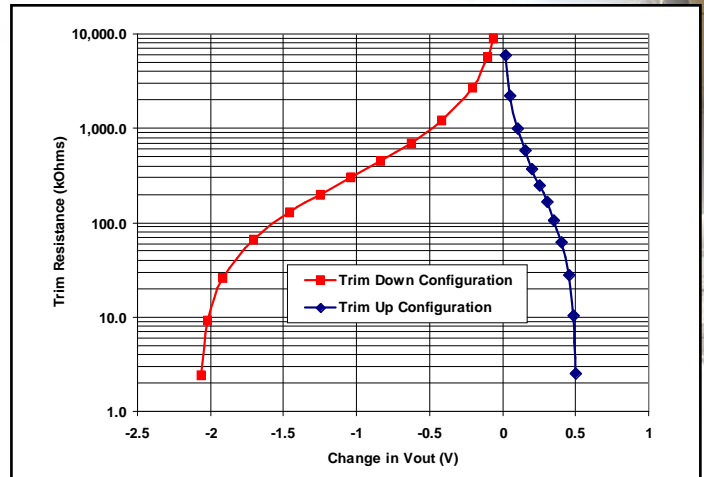

Figure E: Change in Output Voltage Graph

As the output voltage is trimmed up, it produces a greater voltage stress on the converter's internal components and may cause the converter to fail to deliver the desired output voltage at the low end of the input voltage range at the higher end of the load current and temperature range. Please consult the factory for details. Factory trimmed converters are available by request.

INPUT UNDER-VOLTAGE LOCKOUT: The MQFL converter has an under-voltage lockout feature that ensures the converter will be off if the input voltage is too low. The threshold of input voltage at which the converter will turn on is higher than the threshold at which it will turn off. In addition, the MQFL converter will not respond to a state of the input voltage unless it has remained in that state for more than about 200 μ s. This hysteresis and the delay ensure proper operation when the source impedance is high or in a noisy environment.

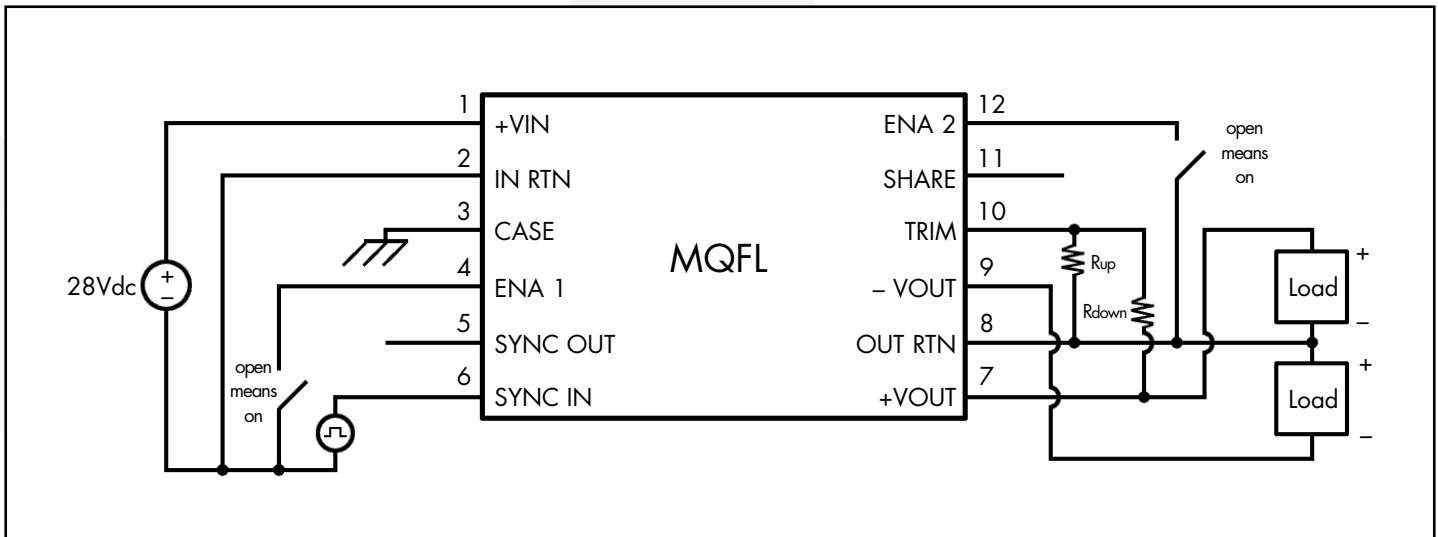

Figure D: Typical connection for output voltage trimming.



Technical Specification

MQFL-28-15D
Output: ± 15 V
Current: 8 A Total

INPUT OVER-VOLTAGE SHUTDOWN: The MQFL converter also has an over-voltage feature that ensures the converter will be off if the input voltage is too high. It also has a hysteresis and time delay to ensure proper operation.

SHUT DOWN: The MQFL converter will shut down in response to only four conditions: ENA1 input low, ENA2 input low, VIN input below under-voltage lockout threshold, or VIN input above over-voltage shutdown threshold. Following a shutdown event, there is a startup inhibit delay which will prevent the converter from restarting for approximately 300ms. After the 300ms delay elapses, if the enable inputs are high and the input voltage is within the operating range, the converter will restart. If the VIN input is brought down to nearly 0V and back into the operating range, there is no startup inhibit, and the output voltage will rise according to the "Turn-On Delay, Rising Vin" specification.

BACK-DRIVE CURRENT LIMIT: Converters that use MOSFETs as synchronous rectifiers are capable of drawing a negative current from the load if the load is a source of short- or long-term energy. This negative current is referred to as a "back-drive current".

Conditions where back-drive current might occur include paralleled converters that do not employ current sharing, or where the current share feature does not adequately ensure sharing during the startup or shutdown transitions. It can also occur when converters having different output voltages are connected together through either explicit or parasitic diodes that, while normally off, become conductive during startup or shutdown. Finally, some loads, such as motors, can return energy to their power rail. Even a load capacitor is a source of back-drive energy for some period of time during a shutdown transient.

To avoid any problems that might arise due to back-drive current, the MQFL converters limit the negative current that the converter can draw from its output terminals. The threshold for this back-drive current limit is placed sufficiently below zero so that the converter may operate properly down to zero load, but its absolute value (see the [Electrical Characteristics](#) page) is small compared to the converter's rated output current.

THERMAL CONSIDERATIONS: Figure 11 shows the suggested Power Derating Curves for this converter as a function of the case temperature and the maximum desired power MOSFET junction temperature. All other components within the converter are cooler than its hottest MOSFET, which at full power is no more than 20°C higher than the case temperature directly below this MOSFET.

The Mil-HDBK-1547A component derating guideline calls for a maximum component temperature of 105°C. Figure 11 therefore has one power derating curve that ensures this limit is maintained. It has been SynQor's extensive experience that reliable long-term converter operation can be achieved with a maximum component temperature of 125°C. In extreme cases, a maximum temperature of 145°C is permissible, but not recommended for long-term operation where high reliability is required. Derating curves for these higher temperature limits are also included in Figure 11. The maximum case temperature at which the converter should be operated is 135°C.

When the converter is mounted on a metal plate, the plate will help to make the converter's case bottom a uniform temperature. How well it does so depends on the thickness of the plate and on the thermal conductance of the interface layer (e.g. thermal grease, thermal pad, etc.) between the case and the plate. Unless this is done very well, it is important not to mistake the plate's temperature for the maximum case temperature. It is easy for them to be as much as 5-10°C different at full power and at high temperatures. It is suggested that a thermocouple be attached directly to the converter's case through a small hole in the plate when investigating how hot the converter is getting. Care must also be made to ensure that there is not a large thermal resistance between the thermocouple and the case due to whatever adhesive might be used to hold the thermocouple in place.

INPUT SYSTEM INSTABILITY: This condition can occur because any DC/DC converter appears incrementally as a negative resistance load. A detailed application note titled "Input System Instability" is available on the [SynQor website](#) which provides an understanding of why this instability arises, and shows the preferred solution for correcting it.



Technical Specification

MQFL-28-15D
Output: ±15 V
Current: 8 A Total

CONSTRUCTION AND ENVIRONMENTAL STRESS SCREENING OPTIONS

| Screening | Consistent with MIL-STD-883F | B-Grade (-40°C to +85°C) | C-Grade (-40°C to +100°C) | ES-Grade (-55°C to +125°C) (Element Evaluation) | HB-Grade (-55°C to +125°C) (Element Evaluation) |
|---|--|--------------------------|---------------------------|---|---|
| Internal Visual | * | Yes | Yes | Yes | Yes |
| Temperature Cycle | Method 1010 | No | No | Condition B (-55°C to +125°C) | Condition C (-65°C to +150°C) |
| Constant Acceleration | Method 2001 (Y1 Direction) | No | No | 500g | Condition A (5000g) |
| Burn-in | Method 1015 Load Cycled •10s period •2s @ 100% Load •8s @ 0% Load | 12 Hrs @ +100°C | 24 Hrs @ +125°C | 96 Hrs @ +125°C | 160 Hrs @ +125°C |
| Final Electrical Test | Method 5005 (Group A) | +25°C | +25°C | -45, +25, +100°C | -55, +25, +125°C |
| Mechanical Seal, Thermal, and Coating Process | | Anodized Package | Full QorSeal | Full QorSeal | Full QorSeal |
| External Visual | 2009 | * | * | Yes | Yes |
| Construction Process | | Ruggedized | QorSeal | QorSeal | QorSeal |
| * Per IPC-A-610 (Rev. D) Class 3 | | | | | |

MilQor converters and filters are offered in four variations of construction technique and environmental stress screening options. The three highest grades, C, ES, and HB, all use SynQor's proprietary QorSeal™ Hi-Rel assembly process that includes a Parylene-C coating of the circuit, a high performance thermal compound filler, and a nickel barrier gold plated aluminum case. The B-grade version uses a ruggedized assembly process that includes a medium performance thermal compound filler and a black anodized aluminum case†. Each successively higher grade has more stringent mechanical and electrical testing, as well as a longer burn-in cycle. The ES- and HB-Grades are also constructed of components that have been procured through an element evaluation process that pre-qualifies each new batch of devices.

† Note: Since the surface of the black anodized case is not guaranteed to be electrically conductive, a star washer or similar device should be used to cut through the surface oxide if electrical connection to the case is desired.



Technical Specification

MQFL-28-15D
Output: ±15 V
Current: 8 A Total

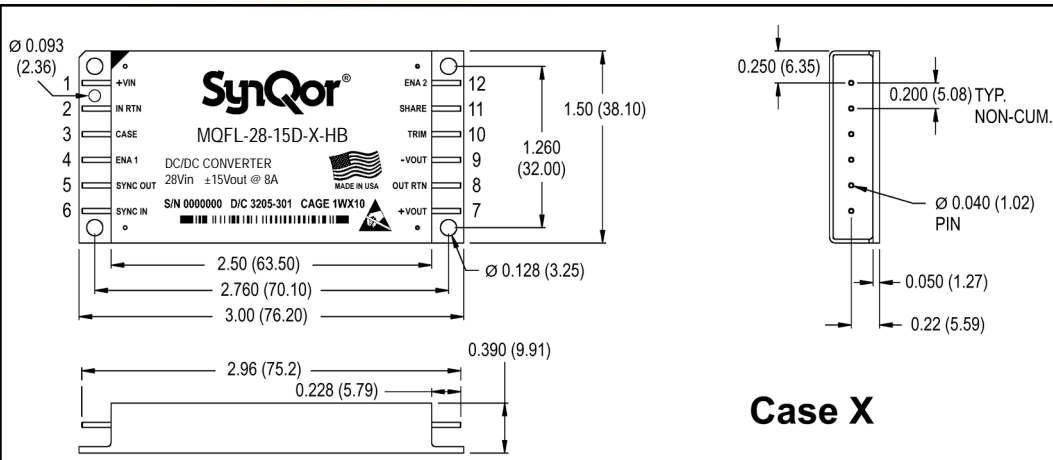

Case X

PACKAGE PINOUTS

| Pin # | Function |
|-------|-----------------|
| 1 | POSITIVE INPUT |
| 2 | INPUT RETURN |
| 3 | CASE |
| 4 | ENABLE 1 |
| 5 | SYNC OUTPUT |
| 6 | SYNC INPUT |
| 7 | POSITIVE OUTPUT |
| 8 | OUTPUT RETURN |
| 9 | NEGATIVE OUTPUT |
| 10 | TRIM |
| 11 | SHARE |
| 12 | ENABLE 2 |

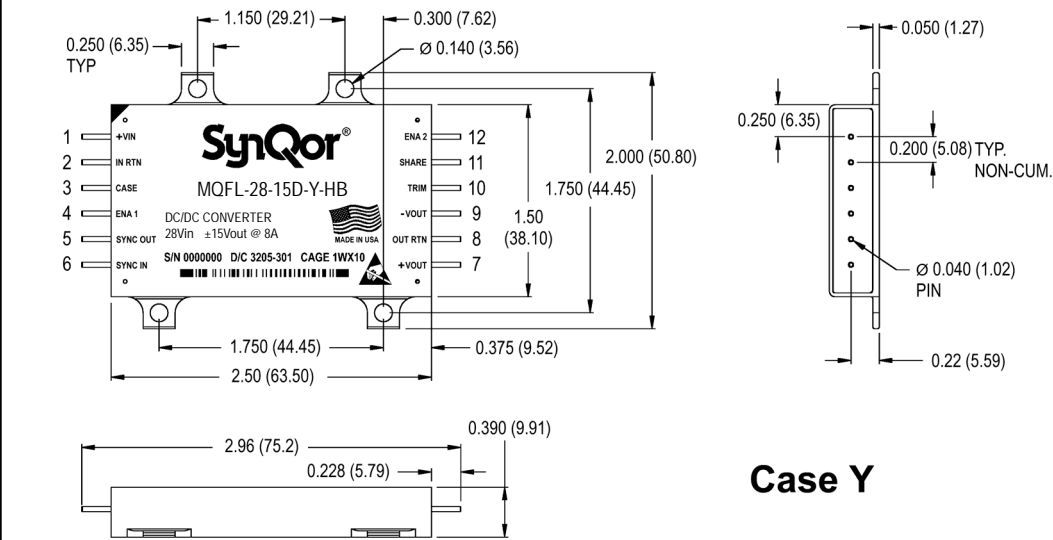

Case Y

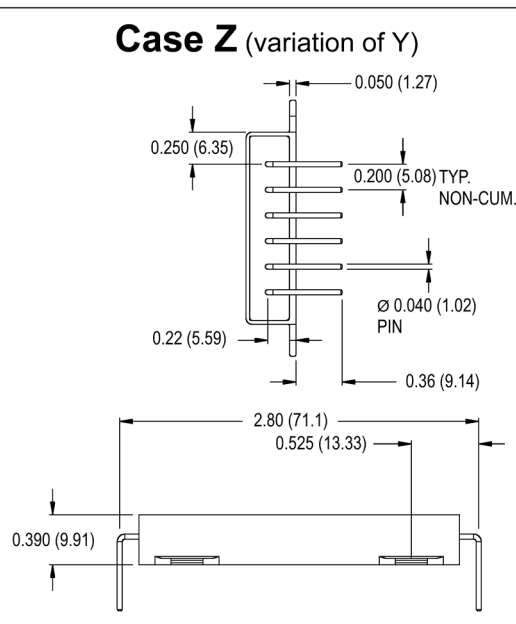
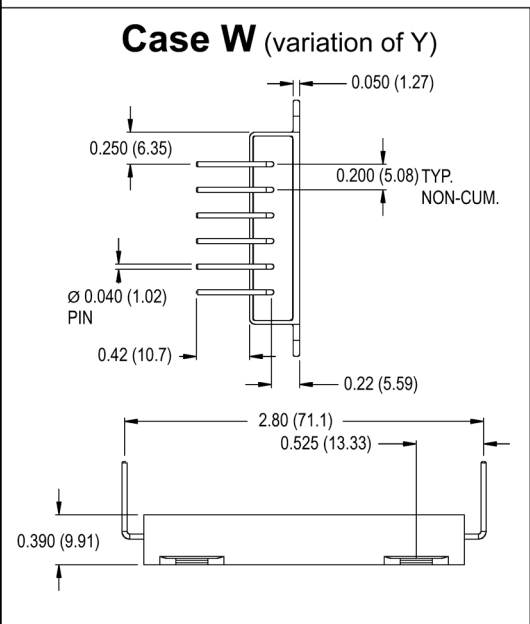

NOTES

- Case: Aluminum with gold over nickel plate finish for the C-, ES-, and HB-Grade products. Aluminum with black anodized finish for the B-Grade products.
- Pins: Diameter: 0.040" (1.02mm)
Material: Copper
Finish: Gold over Nickel plate
- All dimensions as inches (mm)
- Tolerances: a) x.xx ±0.02"
(x.x ±0.5mm)
b) x.xxx ±0.010"
(x.xx ±0.25mm)
- Weight: 2.8 oz. (79 g) typical
- Workmanship: Meets or exceeds IPC-A-610C Class III



Technical Specification

MQFL-28-15D
Output: ±15 V
Current: 8 A Total

MilQor MQFL FAMILY MATRIX

The tables below show the array of MQFL converters available. When ordering SynQor converters, please ensure that you use the complete part number according to the table in the last page. Contact the factory for other requirements.

Single Output Converters

| | 1.5V (1R5S) | 1.8V (1R8S) | 2.5V (2R5S) | 3.3V (3R3S) | 5V (05S) | 6V (06S) | 7.5V (7R5S) | 9V (09S) | 12V (12S) | 15V (15S) | 28V (28S) |
|--|----------------|----------------|----------------|----------------|-------------|-------------|----------------|-------------|--------------|--------------|--------------|
| MQFL-28 16-40Vin Cont. 16-50Vin 1s Trans.* Absolute Max Vin = 60V | 40A | 40A | 40A | 30A | 24A | 20A | 16A | 13A | 10A | 8A | 4A |
| MQFL-28E 16-70Vin Cont. 16-80Vin 1s Trans.* Absolute Max Vin =100V | 40A | 40A | 40A | 30A | 24A | 20A | 16A | 13A | 10A | 8A | 4A |
| MQFL-28V 16-40Vin Cont. 5.5-50Vin 1s Trans.* Absolute Max Vin = 60V | 40A | 40A | 40A | 30A | 20A | 17A | 13A | 11A | 8A | 6.5 | 3.3A |
| MQFL-28VE 16-70Vin Cont. 5.5-80Vin 1s Trans.* Absolute Max Vin = 100V | 40A | 40A | 40A | 30A | 20A | 17A | 13A | 11A | 8A | 6.5 | 3.3A |
| MQFL-270 155-400Vin Cont. 155-475Vin 0.1s Trans.* Absolute Max Vin = 550V | 40A | 40A | 40A | 30A | 24A | 20A | 16A | 13A | 10A | 8A | 4A |
| MQFL-270E 130-475Vin Cont. 130-520Vin 0.1s Trans.* Absolute Max Vin = 600V | 40A | 40A | 40A | 30A | 20A | 17A | 13A | 11A | 8A | 6.5 | 3.3A |
| MQFL-270L 65-350Vin Cont. 65-475Vin 0.1s Trans.* Absolute Max Vin = 550V | 40A | 40A | 30A | 22A | 15A | 12A | 10A | 8A | 6A | 5A | 2.7A |

Dual Output Converters†

| | ±5V (05D) | ±12V (12D) | ±15V (15D) |
|--|--------------|---------------|---------------|
| MQFL-28 16-40Vin Cont. 16-50Vin 1s Trans.* Absolute Max Vin = 60V | 24A Total | 10A Total | 8A Total |
| MQFL-28E 16-70Vin Cont. 16-80Vin 1s Trans.* Absolute Max Vin =100V | 24A Total | 10A Total | 8A Total |
| MQFL-28V 16-40Vin Cont. 5.5-50Vin 1s Trans.* Absolute Max Vin = 60V | 20A Total | 8A Total | 6.5A Total |
| MQFL-28VE 16-70Vin Cont. 5.5-80Vin 1s Trans.* Absolute Max Vin = 100V | 20A Total | 8A Total | 6.5A Total |
| MQFL-270 155-400Vin Cont. 155-475Vin 0.1s Trans.* Absolute Max Vin = 550V | 24A Total | 10A Total | 8A Total |
| MQFL-270E 130-475Vin Cont. 130-520Vin 0.1s Trans.* Absolute Max Vin = 600V | 20A Total | 8A Total | 6.5A Total |
| MQFL-270L 65-350Vin Cont. 65-475Vin 0.1s Trans.* Absolute Max Vin = 550V | 15A Total | 6A Total | 5A Total |

Triple Output Converters

| | 3.3V/±12V (3R312T) | 3.3V/±15V (3R315T) | 5V/±12V (0512T) | 5V/±15V (0515T) | 30V/±15V (3015T) |
|--|-----------------------|-----------------------|--------------------|--------------------|---------------------|
| MQFL-28 16-40Vin Cont. 16-50Vin 1s Trans.* Absolute Max Vin = 60V | 22A/ ±1A | 22A/ ±0.8A | 15A/ ±1A | 15A/ ±0.8A | 2.5A/ ±0.8A |
| MQFL-28E 16-70Vin Cont. 16-80Vin 1s Trans.* Absolute Max Vin =100V | 22A/ ±1A | 22A/ ±0.8A | 15A/ ±1A | 15A/ ±0.8A | 2.5A/ ±0.8A |
| MQFL-28V 16-40Vin Cont. 5.5-50Vin 1s Trans.* Absolute Max Vin = 60V | 22A/ ±1A | 22A/ ±0.8A | 15A/ ±1A | 15A/ ±0.8A | 2.5A/ ±0.8A |
| MQFL-28VE 16-70Vin Cont. 5.5-80Vin 1s Trans.* Absolute Max Vin = 100V | 22A/ ±1A | 22A/ ±0.8A | 15A/ ±1A | 15A/ ±0.8A | 2.5A/ ±0.8A |
| MQFL-270 155-400Vin Cont. 155-475Vin 0.1s Trans.* Absolute Max Vin = 550V | 22A/ ±1A | 22A/ ±0.8A | 15A/ ±1A | 15A/ ±0.8A | 2.5A/ ±0.8A |
| MQFL-270E 130-475Vin Cont. 130-520Vin 0.1s Trans.* Absolute Max Vin = 600V | 22A/ ±1A | 22A/ ±0.8A | 15A/ ±1A | 15A/ ±0.8A | 2.5A/ ±0.8A |
| MQFL-270L 65-350Vin Cont. 65-475Vin 0.1s Trans.* Absolute Max Vin = 550V | 22A/ ±1A | 22A/ ±0.8A | 15A/ ±1A | 15A/ ±0.8A | 2.5A/ ±0.8A |
| (75W _{max} Total Output Power) | | | | | |

*Converters may be operated continuously at the highest transient input voltage, but some component electrical and thermal stresses would be beyond MIL-HDBK-1547A guidelines.

†80% of total output current available on any one output.



Technical Specification

MQFL-28-15D
Output: ±15 V
Current: 8 A Total

PART NUMBERING SYSTEM

The part numbering system for SynQor's *MilQor* DC/DC converters follows the format shown in the table below.

| Model Name | Input Voltage Range | Output Voltage(s) | | | Package Outline/ Pin Configuration | Screening Grade |
|------------|---|-------------------|-------------------|---|---------------------------------------|--------------------|
| | | Single Output | Dual Output | Triple Output | | |
| MQFL | 28 28E 28V 28VE 270 270E 270L | 1R5S | 05D 12D 15D | 3R312T 3R315T 0512T 0515T 3015T | X Y W Z | B C ES HB |
| | | 1R8S | | | | |
| | | 2R5S | | | | |
| | | 3R3S | | | | |
| | | 05S | | | | |
| | | 06S | | | | |
| | | 7R5S | | | | |
| | | 09S | | | | |
| | | 12S | | | | |
| | | 15S | | | | |
| | | 28S | | | | |

Example: MQFL - 28 - 15D - Y - ES

APPLICATION NOTES

A variety of application notes and technical white papers can be downloaded in pdf format from the SynQor [website](#).

PATENTS (additional patent applications may be filed)

SynQor holds the following patents, one or more of which might apply to this product:

| | | | |
|-----------|-----------|-----------|-----------|
| 5,999,417 | 6,222,742 | 6,545,890 | 6,577,109 |
| 6,594,159 | 6,731,520 | 6,894,468 | 6,896,526 |
| 6,927,987 | 7,050,309 | 7,072,190 | 7,085,146 |

Contact SynQor for further information:

Phone: 978-849-0600
Toll Free: 888-567-9596
Fax: 978-849-0602
E-mail: power@synqor.com
Web: www.synqor.com
Address: 155 Swanson Road
 Boxborough, MA 01719
 USA

Warranty

SynQor offers a two (2) year limited warranty. Complete warranty information is listed on our [website](#) or is available upon request from SynQor.

Information furnished by SynQor is believed to be accurate and reliable. However, no responsibility is assumed by SynQor for its use, nor for any infringements of patents or other rights of third parties which may result from its use. No license is granted by implication or otherwise under any patent or patent rights of SynQor.