



CX3VSM CRYSTAL

18 kHz to 600 kHz

Miniature Surface Mount Quartz Crystal for Pierce Oscillators

DESCRIPTION

The CX3VSM quartz crystals are leadless devices designed for surface mounting on printed circuit boards or hybrid substrates. These miniature crystals are intended to be used in Pierce oscillators. They are hermetically sealed in a rugged, miniature ceramic package. They are manufactured using the STATEK-developed photolithographic process, and were designed utilizing the experience acquired by producing millions of crystals for industrial, commercial, military and medical applications. Maximum process temperature should not exceed 260°C.

FEATURES

- Miniature tuning fork design
- High shock resistance
- Designed for low power applications
- Compatible with hybrid or PC board packaging
- Low aging
- Full military testing available
- Ideal for battery operated applications
- Designed and manufactured in the USA

EQUIVALENT CIRCUIT

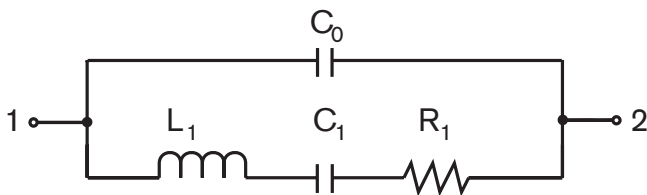

R_1 Motional Resistance L_1 Motional Inductance
 C_1 Motional Capacitance C_0 Shunt Capacitance

SUGGESTED LAND PATTERN

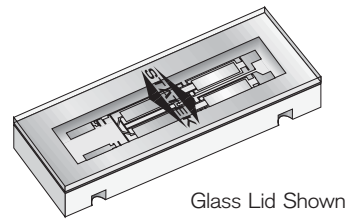
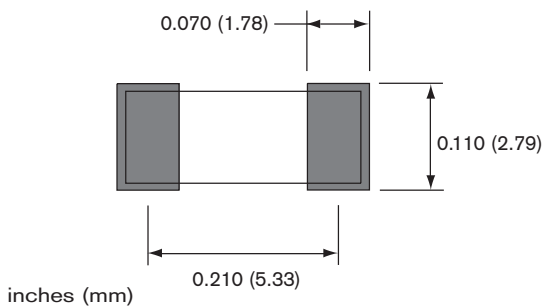

Glass Lid Shown

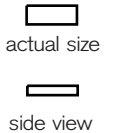

PACKAGE DIMENSIONS

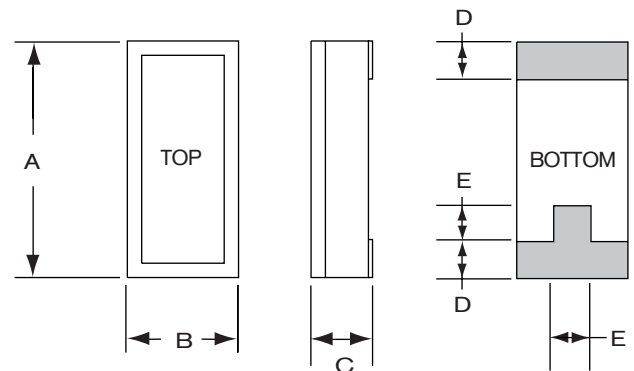

| DIM | TYP. | | MAX. | |
|-----|--------|------|-----------|------|
| | inches | mm | inches | mm |
| A | 0.263 | 6.68 | 0.270 | 6.86 |
| B | 0.097 | 2.46 | 0.104 | 2.64 |
| C | - | - | see below | |
| D | 0.052 | 1.32 | 0.058 | 1.47 |
| E | 0.030 | 0.76 | 0.035 | 0.89 |

| DIM "C" | GLASS LID | | CERAMIC LID | |
|---------|-----------|------|-------------|------|
| | inches | mm | inches | mm |
| MAX | | | | |
| SM1 | 0.053 | 1.35 | 0.067 | 1.70 |
| SM2 | 0.055 | 1.40 | 0.069 | 1.75 |
| SM3 | 0.058 | 1.47 | 0.072 | 1.83 |

CONVENTIONAL CMOS PIERCE OSCILLATOR CIRCUIT

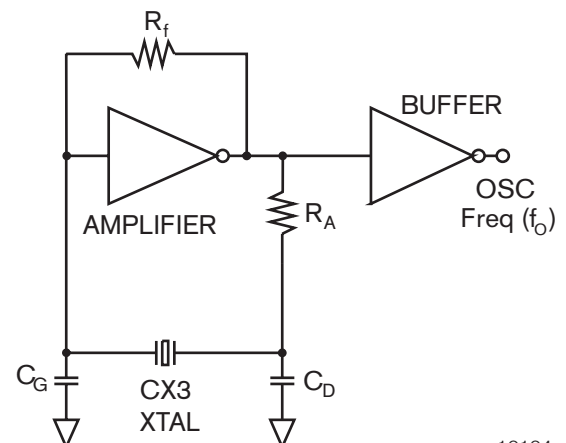

10104 - Rev B



SPECIFICATIONS

Specifications are typical at 25°C unless otherwise noted.

Specifications are subject to change without notice.

Frequency Range 18 kHz to 600 kHz
 Functional Mode Tuning Fork (Flexure)
 Standard Calibration Tolerance* (see table below)
 Motional Resistance (R_1) See Figure 1
 MAX.: 18-25 kHz, 2x Typ.
 25-600 kHz, 2.5x Typ.

Motional Capacitance (C_1) Figure 2
 Quality Factor (Q) Figure 3
 MIN is 0.25x Typ.

Shunt Capacitance (C_0) 1.8 pF MAX
 Drive Level 18-24.9 kHz 0.5 μ W MAX.
 25-600 kHz 1.0 μ W MAX.

Turning Point (T_0)** Figure 4
 Temperature Coefficient (k) -0.035 ppm/°C
 Aging, first year 5 ppm MAX
 Shock, survival*** 1,500 g peak, 0.3 ms, 1/2 sine
 Vibration, survival*** 10 g RMS, 20-2,000 Hz random
 Operating Temp. Range -10°C to +70°C (Commercial)
 -40°C to +85°C (Industrial)
 -55°C to +125°C (Military)

Storage Temp. Range -55°C to +125°C
 Max Process Temperature 260°C for 20 sec.

*Tighter frequency calibration available.

** Other turning point available.

*** Higher shock and vibration available.

CX3V Standard Calibration Tolerance at 25°C

| Frequency Range (kHz) | | | |
|-----------------------|----------------------|----------------------|---------------------|
| 18-74.9 | 75-169.9 | 170-249.9 | 250-600 |
| ± 30 ppm (0.003%) | ± 50 ppm (0.005%) | ± 100 ppm (0.01%) | ±200 ppm (0.02%) |
| ± 100 ppm (0.01%) | ± 100 ppm (0.01%) | ± 200 ppm (0.02%) | ±500 ppm (0.05%) |
| ± 1000 ppm (0.1%) | ± 1000 ppm (0.1%) | ± 2000 ppm (0.2%) | ±5000 ppm (0.5%) |

Load Capacitance (C_L), Used to Calibrate CX3V (other C_L available)

| Frequency Range (kHz) | Load Capacitance (pF) | Frequency Range (kHz) | Load Capacitance (pF) |
|-----------------------|-----------------------|-----------------------|-----------------------|
| 18-24.9 | 10 | 100.1-179.9 | 5 |
| 25-54.9 | 9 | 180-600 | 4 |
| 55-100.0 | 8 | | |

HOW TO ORDER CX3VSM CRYSTALS

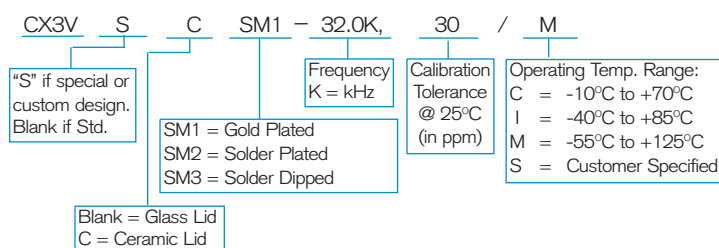

FIGURE 1 CX3V TYPICAL MOTIONAL RESISTANCE (R_1)

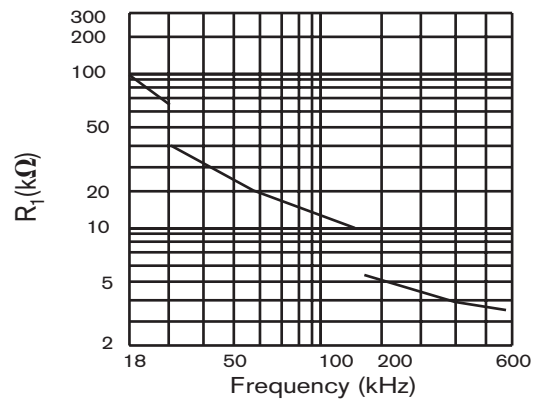

FIGURE 2 CX3V TYPICAL MOTIONAL CAPACITANCE (C_1)

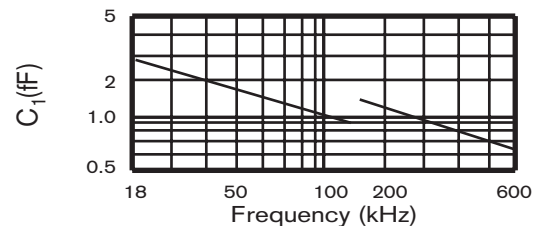

FIGURE 3 CX3V TYPICAL QUALITY FACTOR (Q)

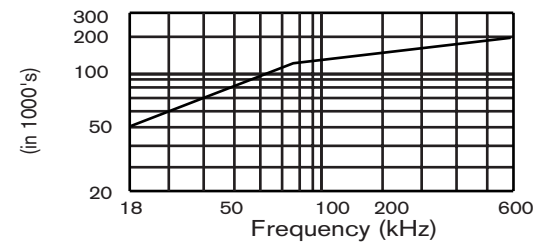
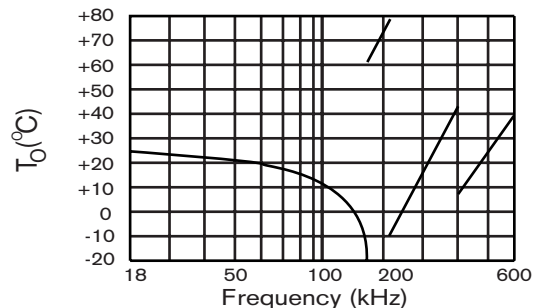

FIGURE 4 CX3V TYPICAL TURNING POINT TEMP. (T_0)



Note: Frequency f at temperature T is related to frequency f_0 at turning point temperature T_0 by: $\frac{f-f_0}{f_0} = k(T-T_0)^2$

TERMINATIONS

| Designation | Termination |
|-------------|---------------|
| SM1 | Gold Plated |
| SM2 | Solder Plated |
| SM3 | Solder Dipped |

PACKAGING OPTIONS

CX3VSM - Tray Pack
 - Tape and Reel
 (Reference tape and reel data sheet 10109)