

DATA SHEET

NEC

NPN SILICON RF TRANSISTOR **2SC5606**

NPN SILICON RF TRANSISTOR FOR LOW NOISE · HIGH-GAIN AMPLIFICATION 3-PIN ULTRA SUPER MINIMOLD (19, 1608 PKG)

FEATURES

- Suitable for high-frequency oscillation
- $f_r = 25$ GHz technology adopted
- 3-pin ultra super minimold (19, 1608 PKG) package

<R> ORDERING INFORMATION

Part Number	Order Number	Package	Quantity	Supplying Form
2SC5606	2SC5606-A	3-pin ultra super minimold (19, 1608 PKG) (Pb-Free)	50 pcs (Non reel)	<ul style="list-style-type: none"> • 8 mm wide embossed taping • Pin 3 (collector) face the perforation side of the tape
2SC5606-T1	2SC5606-T1-A		3 kpcs/reel	

Remark To order evaluation samples, please contact your nearby sales office.
The unit sample quantity is 50 pcs.

ABSOLUTE MAXIMUM RATINGS (T_A = +25°C)

Parameter	Symbol	Ratings	Unit
Collector to Base Voltage	V _{CBO}	15	V
Collector to Emitter Voltage	V _{CEO}	3.3	V
Emitter to Base Voltage	V _{EBO}	1.5	V
Collector Current	I _C	35	mA
Total Power Dissipation	P _{tot} ^{Note}	115	mW
Junction Temperature	T _J	150	°C
Storage Temperature	T _{stg}	-65 to +150	°C

Note Mounted on 1.08 cm² × 1.0 mm (t) glass epoxy substrate

Caution Observe precautions when handling because these devices are sensitive to electrostatic discharge.

The information in this document is subject to change without notice. Before using this document, please confirm that this is the latest version.
Not all products and/or types are available in every country. Please check with an NEC Electronics sales representative for availability and additional information.

ELECTRICAL CHARACTERISTICS (T_A = +25°C)

Parameter	Symbol	Test Conditions	MIN.	TYP.	MAX.	Unit
DC Characteristics						
Collector Cut-off Current	I _{CBO}	V _{CB} = 5 V, I _E = 0 mA	–	–	200	nA
Emitter Cut-off Current	I _{EBO}	V _{EB} = 1 V, I _C = 0 mA	–	–	200	nA
DC Current Gain	h _{FE} ^{Note 1}	V _{CE} = 2 V, I _C = 5 mA	60	80	100	–
RF Characteristics						
Gain Bandwidth Product	f _T	V _{CE} = 2 V, I _C = 20 mA, f = 2 GHz	–	21	–	GHz
Insertion Power Gain	S _{21e} ²	V _{CE} = 2 V, I _C = 20 mA, f = 2 GHz	10	12.5	–	dB
Noise Figure	NF	V _{CE} = 2 V, I _C = 5 mA, f = 2 GHz, Z _S = Z _{opt}	–	1.2	1.5	dB
Reverse Transfer Capacitance	C _{re} ^{Note 2}	V _{CB} = 2 V, I _E = 0 mA, f = 1 MHz	–	0.21	0.3	pF
Maximum Available Power Gain	MAG ^{Note 3}	V _{CE} = 2 V, I _C = 20 mA, f = 2 GHz	–	14	–	dB
Maximum Stable Power Gain	MSG ^{Note 4}	V _{CE} = 2 V, I _C = 20 mA, f = 2 GHz	–	15	–	dB

- Notes** 1. Pulse measurement: PW ≤ 350 μs, Duty Cycle ≤ 2%
 2. Collector to base capacitance when the emitter grounded

3. $MAG = \left| \frac{S_{21}}{S_{12}} \right| (K - \sqrt{K^2 - 1})$

4. $MSG = \left| \frac{S_{21}}{S_{12}} \right|$

h_{FE} CLASSIFICATION

<R>

Rank	FB/YFB
Marking	UA
h _{FE}	60 to 100

<R> **TYPICAL CHARACTERISTICS (Unless otherwise specified, $T_A = +25^\circ\text{C}$)**

TOTAL POWER DISSIPATION vs. AMBIENT TEMPERATURE

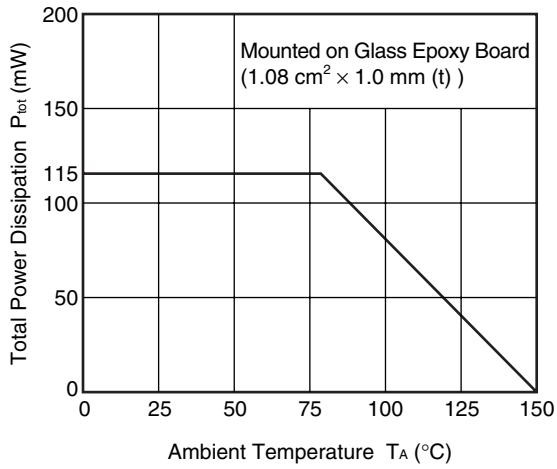

REVERSE TRANSFER CAPACITANCE vs. COLLECTOR TO BASE VOLTAGE

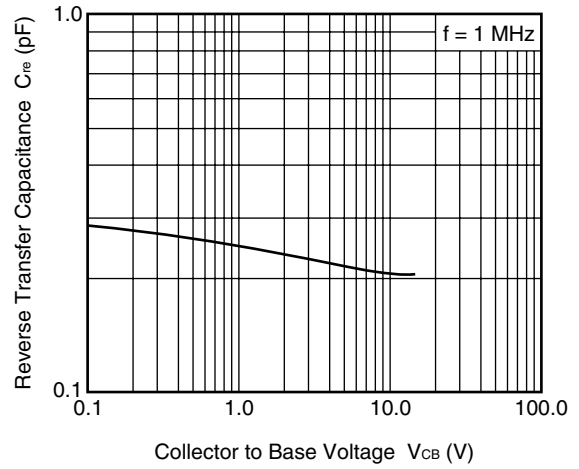

COLLECTOR CURRENT vs. BASE TO EMITTER VOLTAGE

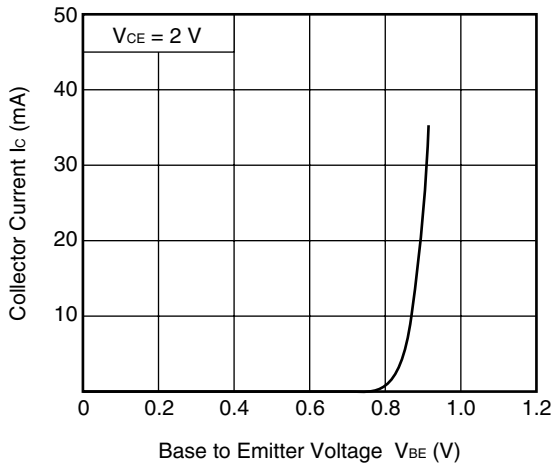

COLLECTOR CURRENT vs. COLLECTOR TO EMITTER VOLTAGE

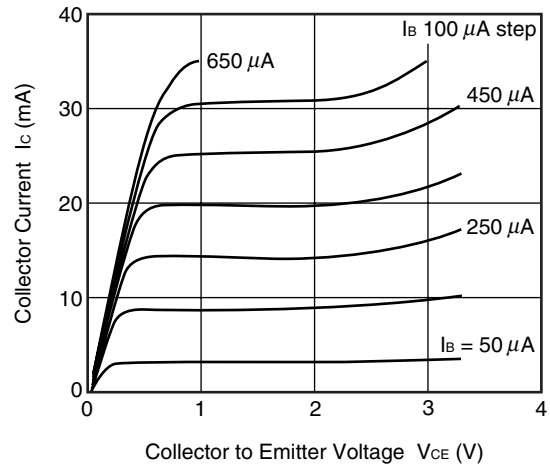

DC CURRENT GAIN vs. COLLECTOR CURRENT

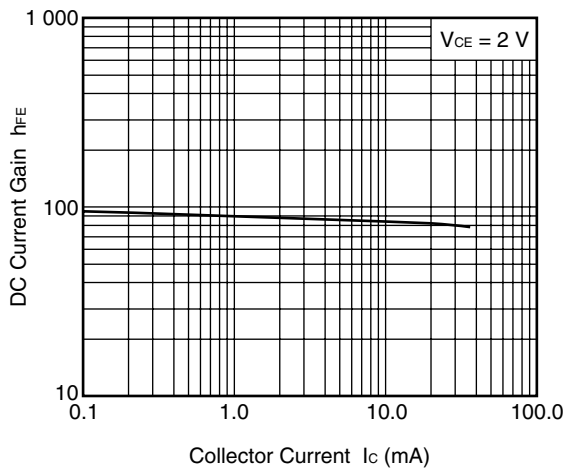

Remark The graphs indicate nominal characteristics.

GAIN BANDWIDTH PRODUCT vs. COLLECTOR CURRENT

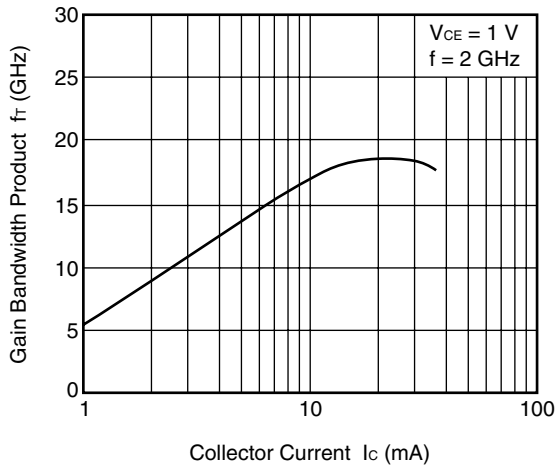

GAIN BANDWIDTH PRODUCT vs. COLLECTOR CURRENT

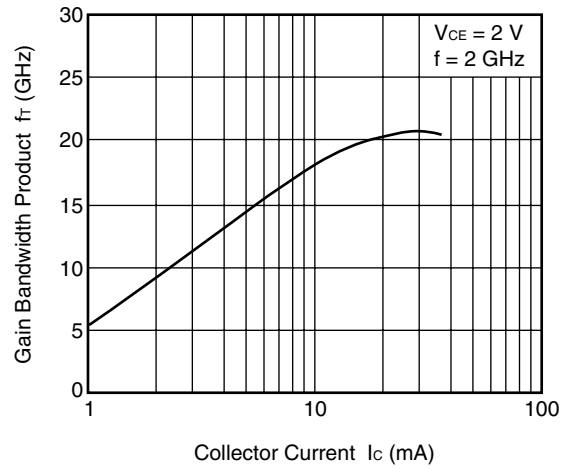

INSERTION POWER GAIN vs. FREQUENCY

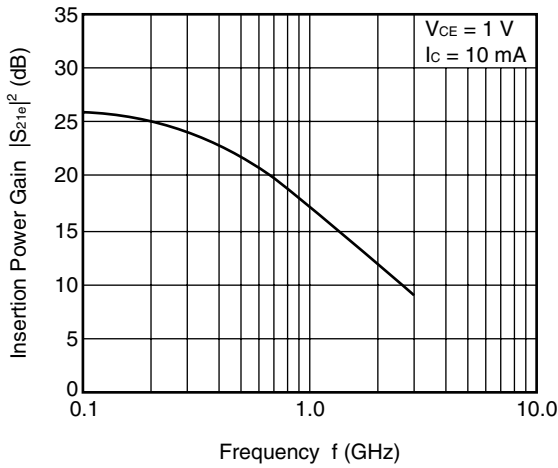

INSERTION POWER GAIN vs. FREQUENCY

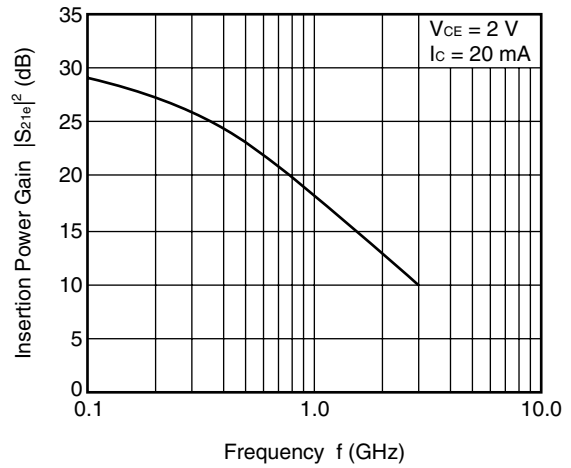

INSERTION POWER GAIN vs. COLLECTOR CURRENT

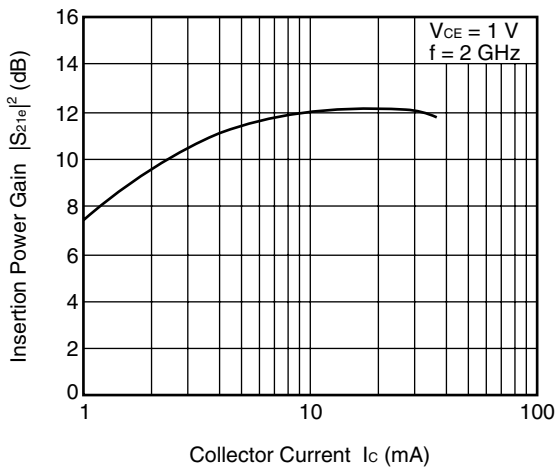

INSERTION POWER GAIN vs. COLLECTOR CURRENT

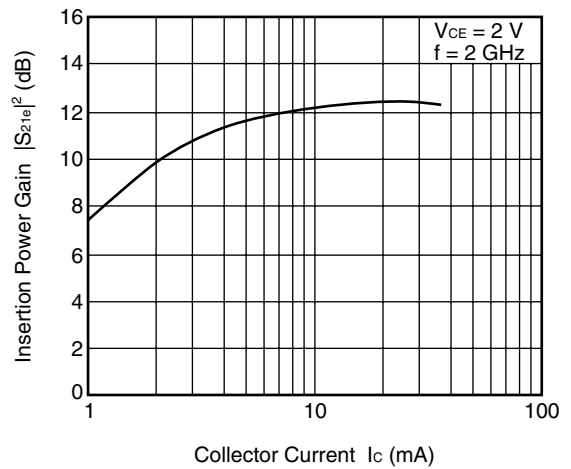

Remark The graphs indicate nominal characteristics.

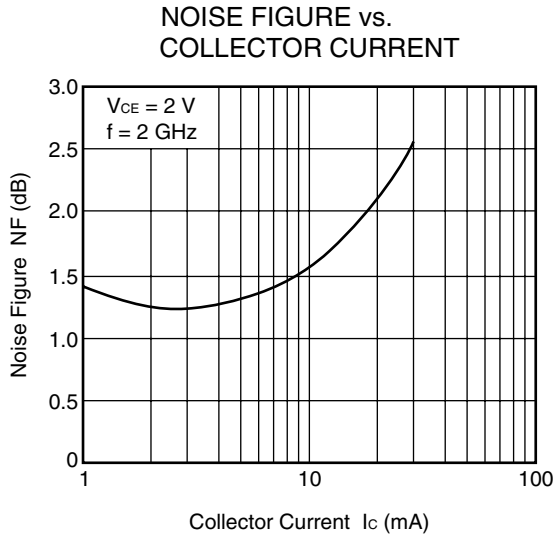

Remark The graph indicates nominal characteristics.

<R> **S-PARAMETERS**

S-parameters and noise parameters are provided on our Web site in a format (S2P) that enables the direct import of the parameters to microwave circuit simulators without the need for keyboard inputs.

Click here to download S-parameters.

[RF and Microwave] → [Device Parameters]

URL <http://www.necel.com/microwave/en/>

PACKAGE DIMENSIONS

3-PIN ULTRA SUPER MINIMOLD (19, 1608 PKG) (UNIT: mm)

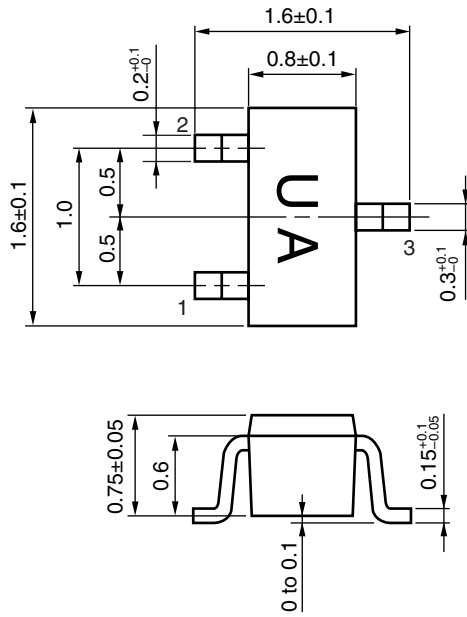

PIN CONNECTIONS

- 1. Emitter
- 2. Base
- 3. Collector

- **The information in this document is current as of August, 2009. The information is subject to change without notice. For actual design-in, refer to the latest publications of NEC Electronics data sheets, etc., for the most up-to-date specifications of NEC Electronics products. Not all products and/or types are available in every country. Please check with an NEC Electronics sales representative for availability and additional information.**
- No part of this document may be copied or reproduced in any form or by any means without the prior written consent of NEC Electronics. NEC Electronics assumes no responsibility for any errors that may appear in this document.
- NEC Electronics does not assume any liability for infringement of patents, copyrights or other intellectual property rights of third parties by or arising from the use of NEC Electronics products listed in this document or any other liability arising from the use of such products. No license, express, implied or otherwise, is granted under any patents, copyrights or other intellectual property rights of NEC Electronics or others.
- Descriptions of circuits, software and other related information in this document are provided for illustrative purposes in semiconductor product operation and application examples. The incorporation of these circuits, software and information in the design of a customer's equipment shall be done under the full responsibility of the customer. NEC Electronics assumes no responsibility for any losses incurred by customers or third parties arising from the use of these circuits, software and information.
- While NEC Electronics endeavors to enhance the quality and safety of NEC Electronics products, customers agree and acknowledge that the possibility of defects thereof cannot be eliminated entirely. In addition, NEC Electronics products are not taken measures to prevent radioactive rays in the product design. When customers use NEC Electronics products with their products, customers shall, on their own responsibility, incorporate sufficient safety measures such as redundancy, fire-containment and anti-failure features to their products in order to avoid risks of the damages to property (including public or social property) or injury (including death) to persons, as the result of defects of NEC Electronics products.
- NEC Electronics products are classified into the following three quality grades: "Standard", "Special" and "Specific".

The "Specific" quality grade applies only to NEC Electronics products developed based on a customer-designated "quality assurance program" for a specific application. The recommended applications of an NEC Electronics product depend on its quality grade, as indicated below. Customers must check the quality grade of each NEC Electronics product before using it in a particular application.

"Standard": Computers, office equipment, communications equipment, test and measurement equipment, audio and visual equipment, home electronic appliances, machine tools, personal electronic equipment and industrial robots.

"Special": Transportation equipment (automobiles, trains, ships, etc.), traffic control systems, anti-disaster systems, anti-crime systems, safety equipment and medical equipment (not specifically designed for life support).

"Specific": Aircraft, aerospace equipment, submersible repeaters, nuclear reactor control systems, life support systems and medical equipment for life support, etc.

The quality grade of NEC Electronics products is "Standard" unless otherwise expressly specified in NEC Electronics data sheets or data books, etc. If customers wish to use NEC Electronics products in applications not intended by NEC Electronics, they must contact an NEC Electronics sales representative in advance to determine NEC Electronics' willingness to support a given application.

(Note)

- (1) "NEC Electronics" as used in this statement means NEC Electronics Corporation and also includes its majority-owned subsidiaries.
- (2) "NEC Electronics products" means any product developed or manufactured by or for NEC Electronics (as defined above).