

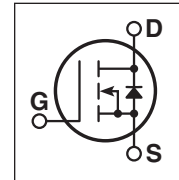

Super Junction MOSFET

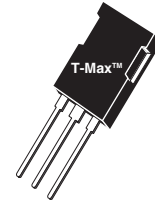

- Ultra Low $R_{DS(ON)}$
- Low Miller Capacitance
- Ultra Low Gate Charge, Q_g
- Avalanche Energy Rated
- Extreme dv/dt Rated
- Dual die (parallel)
- Popular T-MAX Package

Unless stated otherwise, Microsemi discrete MOSFETs contain a single MOSFET die. This device is made with two parallel MOSFET die. It is intended for switch-mode operation. It is not suitable for linear mode operation.

MAXIMUM RATINGS

All Ratings per die: $T_C = 25^\circ\text{C}$ unless otherwise specified.

Symbol	Parameter	APT94N65B2C3S(G)	UNIT
V_{DSS}	Drain-Source Voltage	650	Volts
I_D	Continuous Drain Current @ $T_C = 25^\circ\text{C}$	94	Amps
	Continuous Drain Current @ $T_C = 100^\circ\text{C}$	60	
I_{DM}	Pulsed Drain Current ¹	282	
V_{GS}	Gate-Source Voltage Continuous	20	Volts
P_D	Total Power Dissipation @ $T_C = 25^\circ\text{C}$	415	Watts
T_J, T_{STG}	Operating and Storage Junction Temperature Range	-55 to 150	$^\circ\text{C}$
T_L	Lead Temperature: 0.063" from Case for 10 Sec.	260	
dv/dt	Drain-Source Voltage slope ($V_{DS} = 480\text{V}$, $I_D = 94\text{A}$, $T_J = 125^\circ\text{C}$)	50	V/ns
I_{AR}	Avalanche Current ²	7	Amps
E_{AR}	Repetitive Avalanche Energy ² ($I_D = 7\text{A}$, $V_{DD} = 50\text{V}$)	1	mJ
E_{AS}	Single Pulse Avalanche Energy ($I_D = 3.5\text{A}$, $V_{DD} = 50\text{V}$)	1800	

STATIC ELECTRICAL CHARACTERISTICS

Symbol	Characteristic / Test Conditions	MIN	TYP	MAX	UNIT
$BV_{(DSS)}$	Drain-Source Breakdown Voltage ($V_{GS} = 0\text{V}$, $I_D = 500\mu\text{A}$)	650			Volts
$R_{DS(on)}$	Drain-Source On-State Resistance ³ ($V_{GS} = 10\text{V}$, $I_D = 60\text{A}$)		0.03	0.035	Ohms
I_{DSS}	Zero Gate Voltage Drain Current ($V_{DS} = 600\text{V}$, $V_{GS} = 0\text{V}$)		1.0	50	μA
	Zero Gate Voltage Drain Current ($V_{DS} = 600\text{V}$, $V_{GS} = 0\text{V}$, $T_C = 150^\circ\text{C}$)		100		
I_{GSS}	Gate-Source Leakage Current ($V_{GS} = \pm 20\text{V}$, $V_{DS} = 0\text{V}$)			± 200	nA
$V_{GS(th)}$	Gate Threshold Voltage ($V_{DS} = V_{GS}$, $I_D = 5.8\text{mA}$)	2.1	3	3.9	Volts

 CAUTION: These Devices are Sensitive to Electrostatic Discharge. Proper Handling Procedures Should Be Followed.

"COOLMOS™" comprise a new family of transistors developed by Infineon Technologies AG. "COOLMOS" is a trademark of Infineon Technologies AG."

Microsemi Website - <http://www.microsemi.com>

DYNAMIC CHARACTERISTICS

APT94N65B2C3(G)

Symbol	Characteristic	Test Conditions	MIN	TYP	MAX	UNIT
C_{iss}	Input Capacitance	$V_{GS} = 0V$ $V_{DS} = 25V$ $f = 1\text{ MHz}$		13940		pF
C_{oss}	Output Capacitance			5200		
C_{rss}	Reverse Transfer Capacitance			229		
Q_g	Total Gate Charge ⁴	$V_{GS} = 10V$ $V_{DD} = 300V$ $I_D = 94A @ 25^\circ C$		580		nC
Q_{gs}	Gate-Source Charge			72		
Q_{gd}	Gate-Drain ("Miller") Charge			234		
$t_{d(on)}$	Turn-on Delay Time	INDUCTIVE SWITCHING $V_{GS} = 15V$ $V_{DD} = 400V$ $I_D = 94A @ 25^\circ C$ $R_G = 4.3\Omega$		32		ns
t_r	Rise Time			59		
$t_{d(off)}$	Turn-off Delay Time			498		
t_f	Fall Time			167		
E_{on}	Turn-on Switching Energy ⁵	INDUCTIVE SWITCHING @ 25°C $V_{DD} = 400V, V_{GS} = 15V$ $I_D = 94A, R_G = 4.3\Omega$		2684		μJ
E_{off}	Turn-off Switching Energy			4448		
E_{on}	Turn-on Switching Energy ⁵	INDUCTIVE SWITCHING @ 125°C $V_{DD} = 400V, V_{GS} = 15V$ $I_D = 94A, R_G = 4.3\Omega$		3391		
E_{off}	Turn-off Switching Energy			5082		

SOURCE-DRAIN DIODE RATINGS AND CHARACTERISTICS

Symbol	Characteristic / Test Conditions	MIN	TYP	MAX	UNIT
I_S	Continuous Source Current (Body Diode)		47		Amps
I_{SM}	Pulsed Source Current ¹ (Body Diode)		141		Amps
V_{SD}	Diode Forward Voltage ³ ($V_{GS} = 0V, I_S = -94A$)		0.9	1.2	Volts
dv/dt	Peak Diode Recovery dv/dt ⁶		50		V/ns
t_{rr}	Reverse Recovery Time ($I_S = -94A, di/dt = 100A/\mu s$)	$T_J = 25^\circ C$		960	ns
		$T_J = 125^\circ C$		1271	
Q_{rr}	Reverse Recovery Charge ($I_S = -94A, di/dt = 100A/\mu s$)	$T_J = 25^\circ C$		31	μC
		$T_J = 125^\circ C$		43	
I_{RRM}	Peak Recovery Current ($I_S = -94A, di/dt = 100A/\mu s$)	$T_J = 25^\circ C$		58	Amps
		$T_J = 125^\circ C$		56	

THERMAL CHARACTERISTICS

Symbol	Characteristic	MIN	TYP	MAX	UNIT
$R_{\theta JC}$	Junction to Case			0.15	$^\circ C/W$
$R_{\theta JA}$	Junction to Ambient			31	

- 1 Repetitive Rating: Pulse width limited by maximum junction temperature
- 2 Repetitive avalanche causes additional power losses that can be calculated as $P_{AV} = E_{AR} * f$. **Pulse width tp limited by Tj max.**
- 3 Pulse Test: Pulse width < 380 μs , Duty Cycle < 2%

- 4 See MIL-STD-750 Method 3471
- 5 Eon includes diode reverse recovery.
- 6 Maximum 125°C diode commutation speed = di/dt 600A/ μs

Microsemi reserves the right to change, without notice, the specifications and information contained herein.

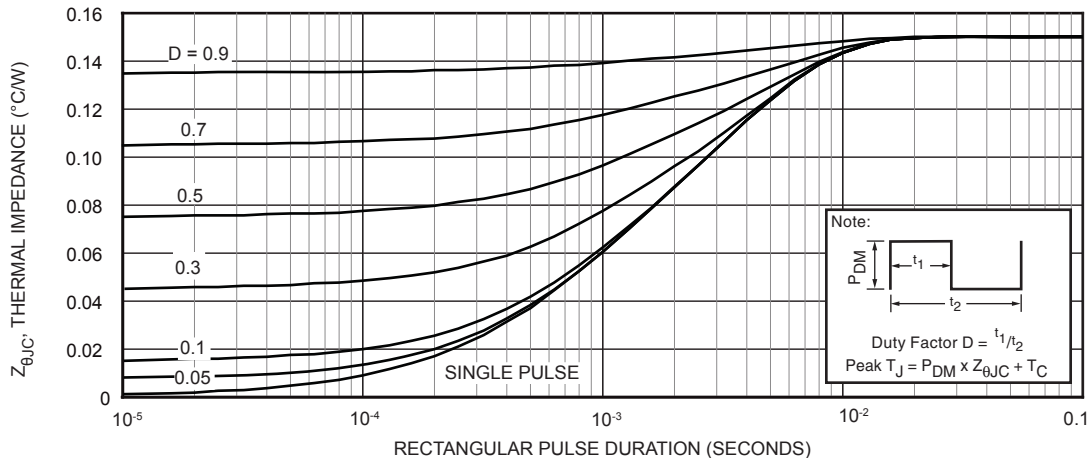

Figure 1, Maximum Effective Transient Thermal Impedance, Junction-To-Case vs Pulse Duration

Typical Performance Curves

APT94N65B2C3(G)

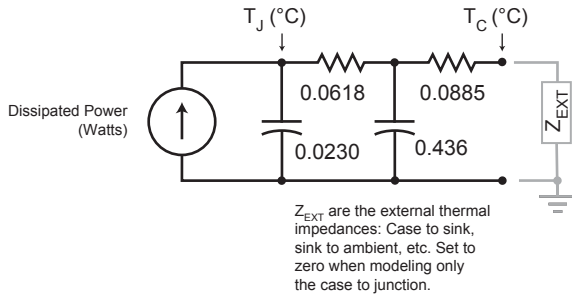

FIGURE 2, TRANSIENT THERMAL IMPEDANCE MODEL

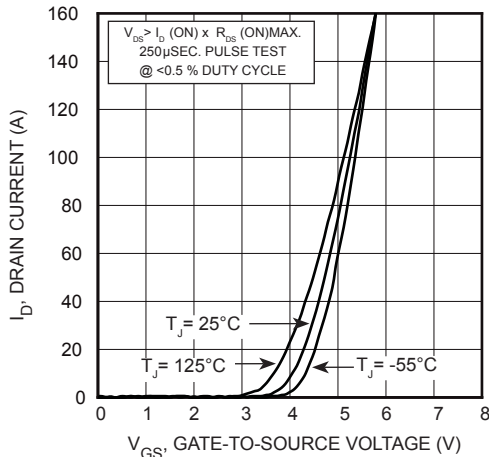

FIGURE 12, Transfer Characteristics

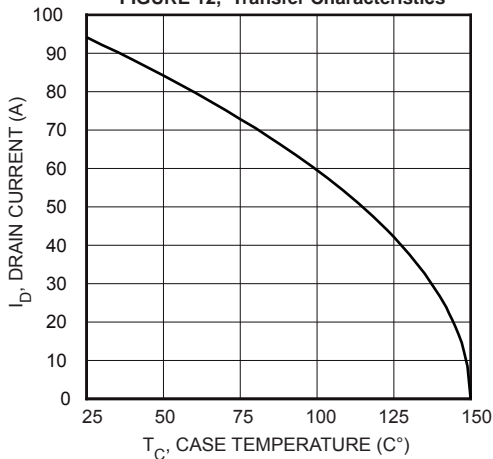

FIGURE 6, Maximum Drain Current vs Case Temperature

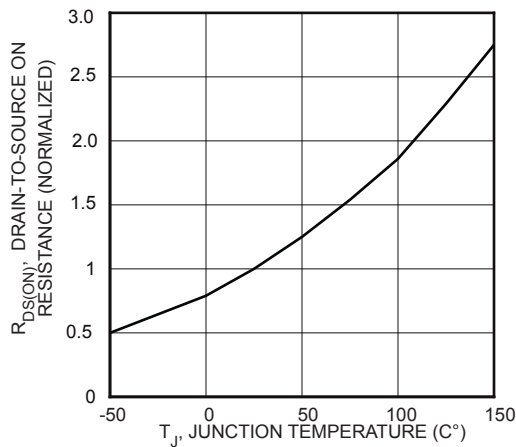

FIGURE 8, On-Resistance vs Temperature

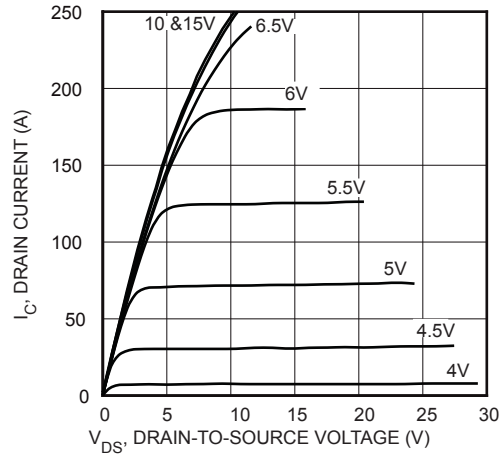

FIGURE 11, Low Voltage Output Characteristics

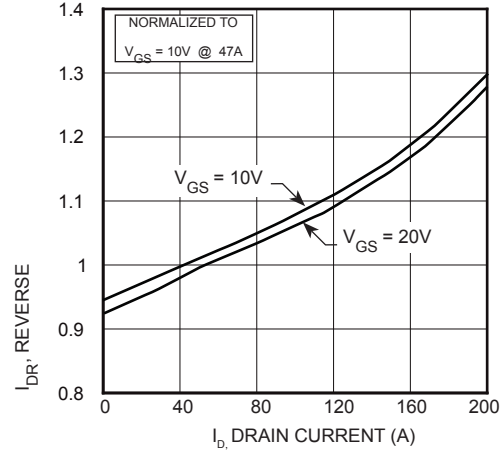

FIGURE 13, $R_{DS(ON)}$ vs Drain Current

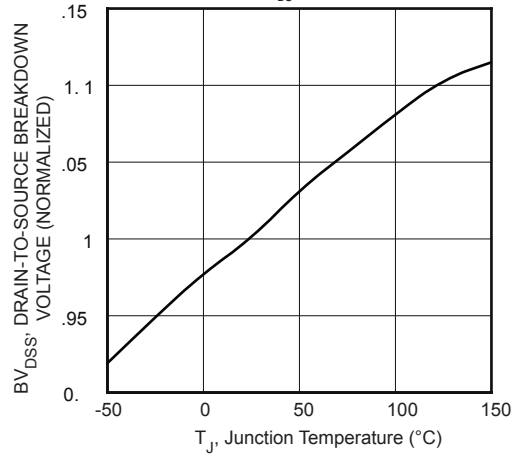

FIGURE 7, Breakdown Voltage vs Temperature

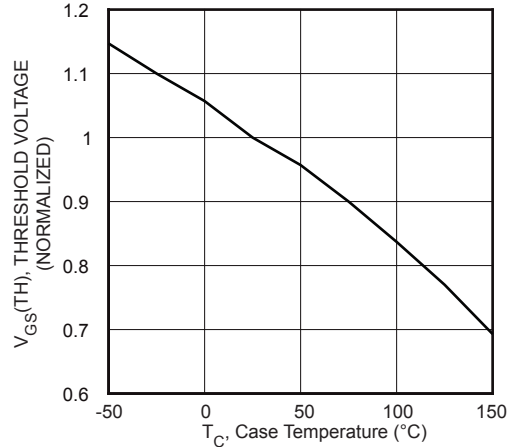

FIGURE 9, Threshold Voltage vs Temperature

Typical Performance Curves

APT94N65B2C3(G)

I_D , DRAIN CURRENT (A)

GRAPH REMOVED

V_{DS} , DRAIN-TO-SOURCE VOLTAGE (V)
FIGURE 10, Maximum Safe Operating Area

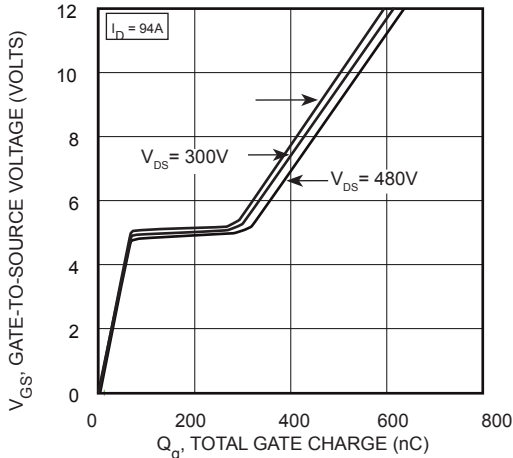

FIGURE 12, Gate Charges vs Gate-To-Source Voltage

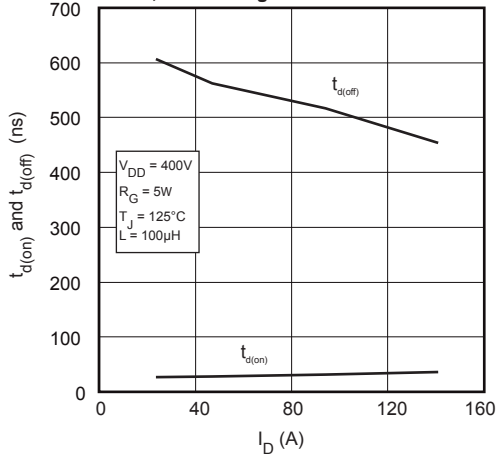

FIGURE 14, Delay Times vs Current

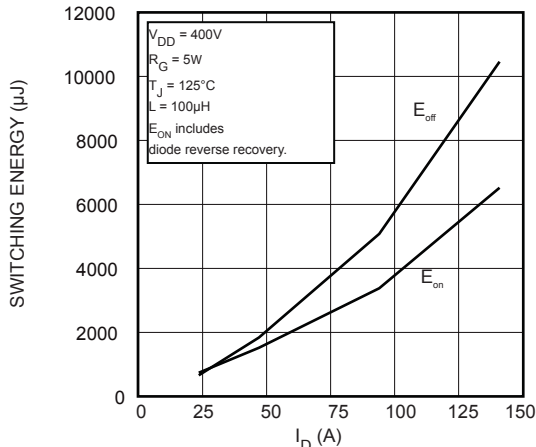
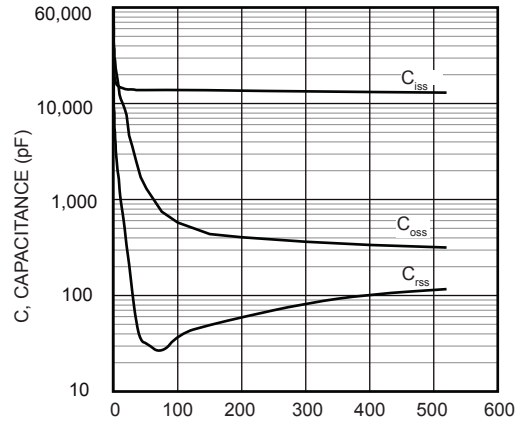

FIGURE 16, Switching Energy vs Current



V_{DS} , DRAIN-TO-SOURCE VOLTAGE (V)
FIGURE 11, Capacitance vs Drain-To-Source Voltage

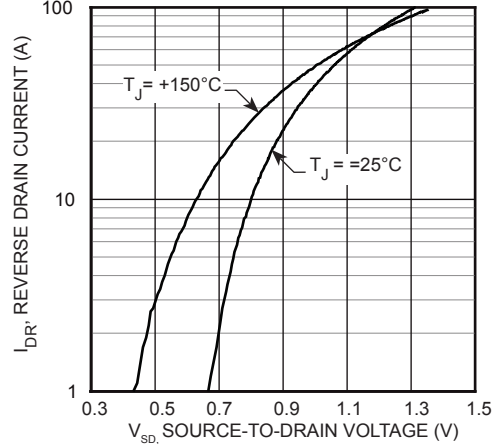

FIGURE 13, Source-Drain Diode Forward Voltage

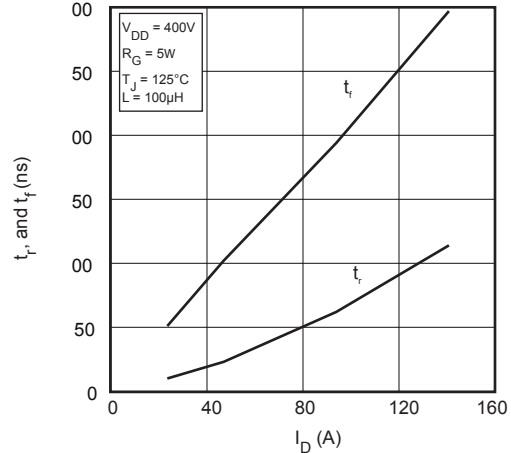

FIGURE 15, Rise and Fall Times vs Current

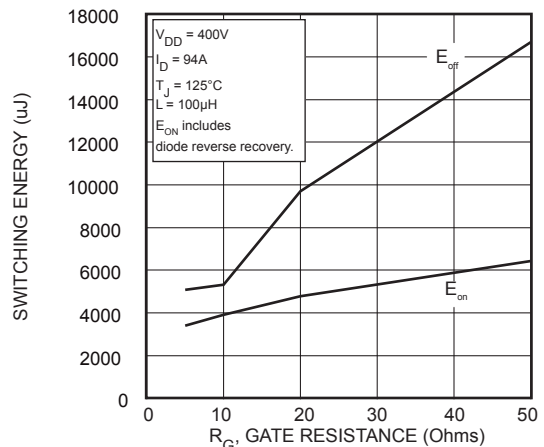

FIGURE 17, Switching Energy vs Gate Resistance

Typical Performance Curves

APT94N65B2C3(G)

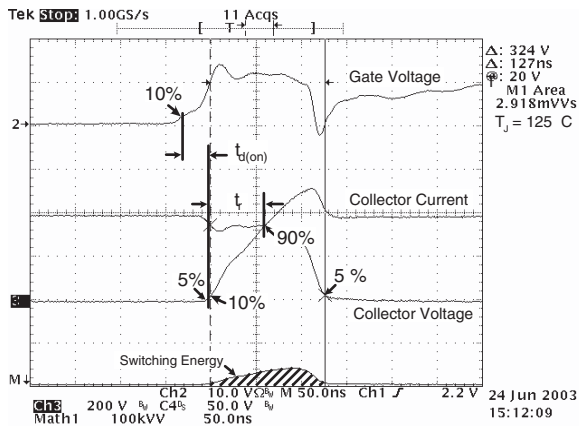

Figure 18, Turn-on Switching Waveforms and Definitions

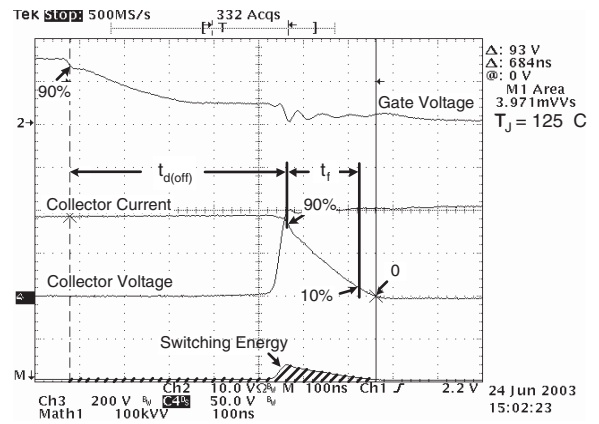

Figure 19, Turn-off Switching Waveforms and Definitions

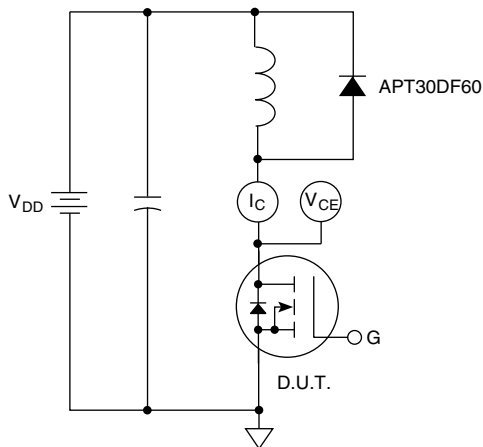
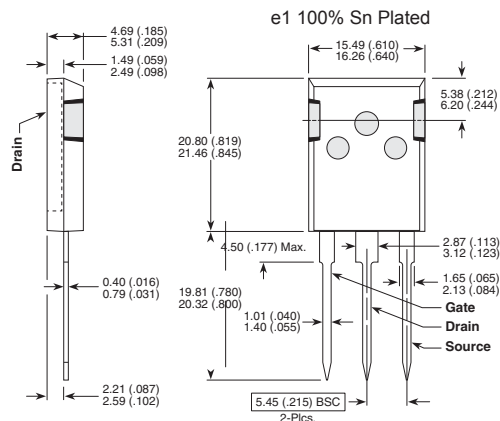

Figure 20, Inductive Switching Test Circuit

T-MAX[®] (B2) Package Outline



These dimensions are equal to the TO-247 without the mounting hole.
Dimensions in Millimeters and (Inches)

Microsemi's products are covered by one or more of U.S. patents 4,895,810 5,045,903 5,089,434 5,182,234 5,019,522 5,262,336 6,503,786 5,256,583 4,748,103 5,283,202 5,231,474 5,434,095 5,528,058 6,939,743, 7,352,045 5,283,201 5,801,417 5,648,283 7,196,634 6,664,594 7,157,886 6,939,743 7,342,262 and foreign patents. US and Foreign patents pending. All Rights Reserved.