

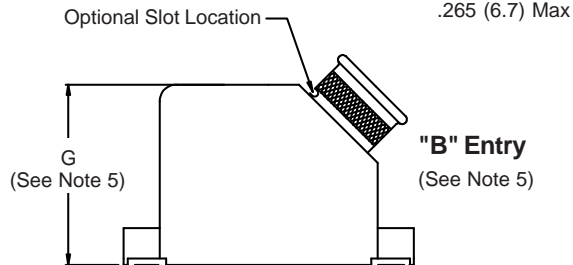

557-316

EMI/RFI Banding Backshell Assembly, RFI/EMI with Optional Qwik-Ty® for MIL-C-24308 Connectors

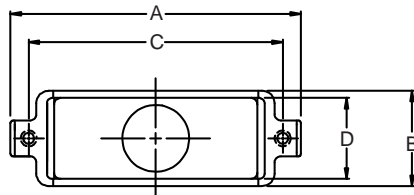
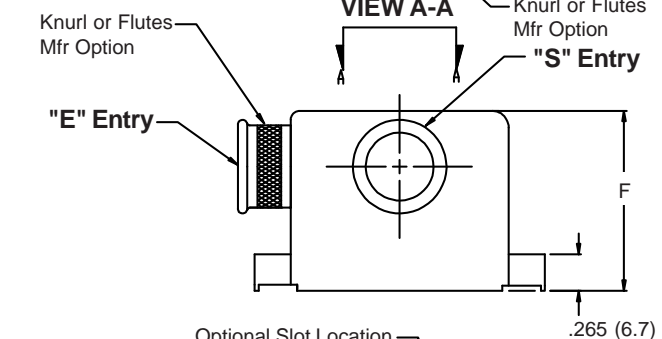
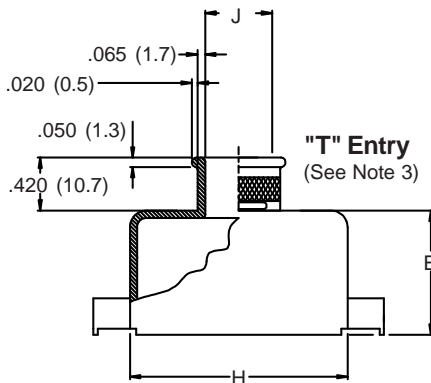
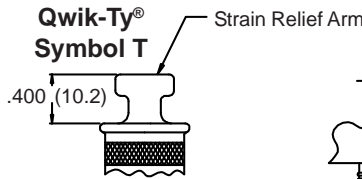
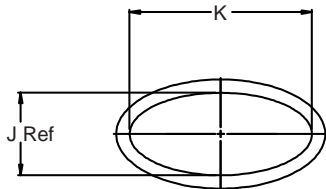
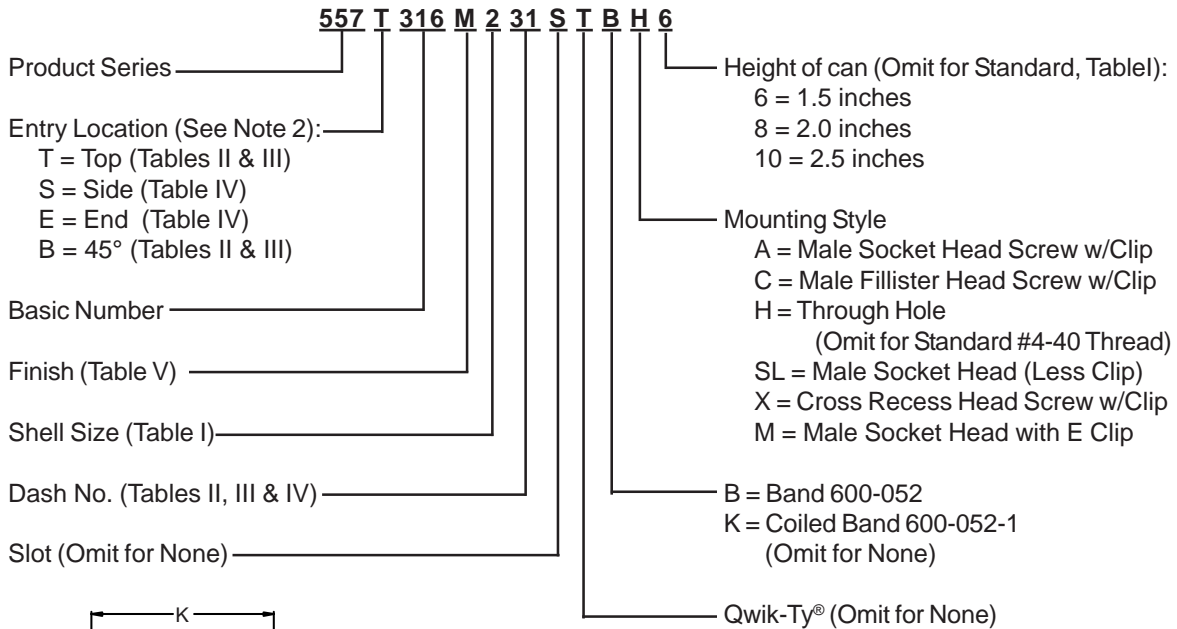

Metric dimensions (mm) are indicated in parentheses

557-316
EMI/RFI Banding Backshell Assembly, RFI/EMI
 with Optional Qwik-Ty® for MIL-C-24308 Connectors



MIL-C-24308
 D-Subminiature

TABLE I: CONNECTOR INTERFACE AND BACKSHELL DIMENSIONS

Shell Size	A Max	B +.020 (0.5)	C ±.005 (0.1)	D Ref	E Max	F Max	G Max	H Ref
1	1.250 (31.8)	.520 (13.2)	.984 (25.0)	.440 (11.2)	.695 (17.7)	1.413 (35.9)	1.035 (26.3)	.856 (21.7)
2	1.580 (40.1)	.520 (13.2)	1.312 (33.3)	.440 (11.2)	.695 (17.7)	1.413 (35.9)	1.035 (26.3)	1.186 (30.1)
3	2.130 (54.1)	.520 (13.2)	1.852 (47.0)	.440 (11.2)	.695 (17.7)	1.413 (35.9)	1.035 (26.3)	1.727 (43.9)
4	2.770 (70.4)	.520 (13.2)	2.500 (63.5)	.440 (11.2)	.695 (17.7)	1.595 (40.5)	1.035 (26.3)	2.838 (72.1)
5	2.680 (68.1)	.629 (16.0)	2.406 (61.1)	.549 (13.9)	1.135 (28.8)	1.595 (40.5)	1.125 (28.6)	2.287 (58.1)
6	2.770 (70.4)	.629 (16.0)	2.500 (63.5)	.610 (15.5)	1.265 (32.1)	1.595 (40.5)	1.185 (30.1)	2.405 (61.1)

TABLE II: TOP/45° ENTRY LOCATION SHELL SIZES 1-4 ONLY

Shell Size	J Dia	K Dim	L Dim	M Dim
16	.188 (4.8)	N/A	.190 (4.8)	.080 (2.0)
18	.205 (5.2)	N/A	.200 (5.1)	.080 (2.0)
23	.250 (6.4)	N/A	.220 (5.6)	.080 (2.0)
30	.312 (7.9)	N/A	.250 (6.4)	.080 (2.0)
31	.375 (9.5)	N/A	.280 (7.1)	.080 (2.0)
32*	.438 (11.1)	N/A	.310 (7.9)	.080 (2.0)
33*	.562 (14.3)	.723 (18.4)	.380 (9.7)	.080 (2.0)
34*	.650 (16.5)	.967 (24.6)	.440 (11.2)	.080 (2.0)
35*	.562 (14.3)	1.250 (31.8)	.450 (11.4)	.080 (2.0)
00*	N/A	N/A	N/A	N/A

* See Note 3 for Dash Numbers 32 & 33. See Notes 3 and 4 for Dash No. 00. See Notes 3 and 5 for Dash Nos. 35 & 35.

TABLE III: TOP/45° ENTRY LOCATION SHELL SIZES 5 & 6 ONLY

Shell Size	J Dia	K Dim	L Dim	M Dim
16	.188 (4.8)	N/A	.190 (4.8)	.080 (2.0)
23	.250 (6.4)	N/A	.220 (5.6)	.080 (2.0)
30	.312 (7.9)	N/A	.250 (6.4)	.080 (2.0)
31	.375 (9.5)	N/A	.280 (7.1)	.080 (2.0)
32	.438 (11.1)	N/A	.310 (7.9)	.080 (2.0)
33*	.562 (14.3)	N/A	.380 (9.7)	.080 (2.0)
34*	.650 (16.5)	.967 (24.6)	.440 (11.2)	.080 (2.0)
35*	.562 (14.3)	1.250 (31.8)	.450 (11.4)	.080 (2.0)
00*	N/A	N/A	N/A	N/A

* See Note 3 for Dash Numbers 32 & 33. See Notes 3 and 5 for Dash Nos. 43 & 35. See Notes 3 and 4 for Dash No. 00.

TABLE IV: SIDE/END ENTRY SHELL SIZES 5 & 6 ONLY

Shell Size	J Dia	K Dim	L Dim	M Dim
16	.188 (4.8)	N/A	.190 (4.8)	.080 (2.0)
23	.250 (6.4)	N/A	.220 (5.6)	.080 (2.0)
30	.312 (7.9)	N/A	.250 (6.4)	.080 (2.0)
31	.375 (9.5)	N/A	.280 (7.1)	.080 (2.0)
32	.438 (11.1)	N/A	.310 (7.9)	.080 (2.0)
33	.562 (14.3)	N/A	.380 (9.7)	.080 (2.0)
34	.650 (16.5)	N/A	.440 (11.2)	.080 (2.0)
36	.650 (16.5)	.967 (24.6)	.450 (11.4)	.080 (2.0)
00*	N/A	N/A	N/A	N/A

* See Note 4 for Dash Number 00.

NOTES:

- Metric dimensions (mm) are indicated in parentheses.
- For Multiple Entries select two letters to indicate choice, i.e.: SE = Side and End Entries.
- For Die Cast Backshell, entry may be elliptical in shape. Consult factory for Entry Dimensions.
- "00" indicates Shorting can Option. Available on T and E Configurations only.
- For "B" Configuration, Dash Nos. 34 & 35 can height to be 1.8000 (45.7)

TABLE III: FINISH OPTIONS

Symbol	Finish
B	Cadmium Plate/Olive Drab
C*	Black Anodize
G*	Anodic Hard Coat
J	Gold Iridite over Cadmium Plate over Electroless Nickel
LF	Cadmium Plate/Bright over Electroless Nickel
M	Electroless Nickel
N	Cadmium Plate/Olive Drab over Electroless Nickel
NC	Zinc Cobalt/Dark Olive Drab
NF	Cadmium Plate/Olive Drab over Electroless Nickel
T	Cadmium Plate/Bright over Electroless Nickel
U**	Cadmium Plate/Black
ZN	Zinc-Nickel Alloy/Olive Drab

*Anodize finish is not suitable for EMI shielding or grounding applications.
 **Applicable to corrosion resisting steel backshells and accessories. Consult factory for other available finishes.