

# DATA SHEET

# NEC

## CMOS INTEGRATED CIRCUIT $\mu$ PD5715GR

### CMOS MMIC 4 x 2 IF SWITCH MATRIX

#### FEATURES

- 4 independent IF channels, integral switching to channel input to either channel output
- Integrated 4 bit decoder
- Frequency range :  $f = 250$  to  $2\ 150$  MHz
- High isolation D/U ratio : ISL = 29 dB TYP.
- Insertion loss :  $L_{INS} = 6.7$  dB TYP. @  $Z_0 = 50\ \Omega$
- Insertion loss flatness :  $\Delta L_{INS} = 0.7$  dB TYP.
- Control voltage :  $V_{CONT} = 0\ V/+3.3\ V$
- 16-pin plastic HTSSOP package

#### APPLICATIONS

- DBS IF switching
- Switch box
- $4 \times 2$  switching application for microwave signal

#### ORDERING INFORMATION

Part Number	Order Number	Package	Marking	Supplying Form
$\mu$ PD5715GR-E1	$\mu$ PD5715GR-E1-A	16-pin plastic HTSSOP (Pb-Free)	D5715	<ul style="list-style-type: none"><li>• Embossed tape 12 mm wide</li><li>• Pin 8, 9 face the perforation side of the tape</li><li>• Qty 3 kpcs/reel</li></ul>

**Remark** To order evaluation samples, contact your nearby sales office.

Part number for sample order:  $\mu$ PD5715GR

**Caution** Observe precautions when handling because these devices are sensitive to electrostatic discharge.

The information in this document is subject to change without notice. Before using this document, please confirm that this is the latest version.  
Not all products and/or types are available in every country. Please check with an NEC Electronics sales representative for availability and additional information.

**ABSOLUTE MAXIMUM RATINGS (T<sub>A</sub> = +25°C, unless otherwise specified)**

Parameter	Symbol	Ratings	Unit
Supply Voltage	V <sub>DD</sub>	+4.6	V
Switch Control Voltage 1 to 4	V <sub>CONT1 to4</sub>	+4.6	V
Total Power Dissipation	P <sub>tot</sub>	2 <sup>Note</sup>	W
Input Power	P <sub>in</sub>	+15	dBm
Operating Ambient Temperature	T <sub>A</sub>	-40 to +85	°C
Storage Temperature	T <sub>stg</sub>	-65 to +150	°C

**Note** Mounted on double-sided copper-clad 50 × 50 × 1.6 mm epoxy glass PWB, T<sub>A</sub> = +85°C

**RECOMMENDED OPERATING CONDITIONS (T<sub>A</sub> = +25°C)**

Parameter	Symbol	MIN.	TYP.	MAX.	Unit
Supply Voltage	V <sub>DD</sub>	+3.0	+3.3	+3.6	V
Control Voltage (H) <sup>Note</sup>	V <sub>CONT (H)</sub>	+3.0	+3.3	+3.6	V
Control Voltage (L)	V <sub>CONT (L)</sub>	-0.2	0	+0.4	V

**Note** V<sub>DD</sub>-0.4 V ≤ V<sub>CONT (H)</sub> ≤ V<sub>DD</sub>+0.2 V

**ELECTRICAL CHARACTERISTICS (T<sub>A</sub> = +25°C, V<sub>DD</sub> = +3.3 V, V<sub>CONT</sub> = 0 V/+3.3 V, P<sub>in</sub> = 0 dBm, Z<sub>o</sub> = 50 Ω, each port, unless otherwise specified)**

Parameter	Symbol	Test Conditions	MIN.	TYP.	MAX.	Unit
Insertion Loss	L <sub>INS</sub>	f = 0.25 to 2.15 GHz	-	6.7	9.0	dB
Insertion Loss Flatness	ΔL <sub>INS</sub>	L <sub>INS</sub> (0.95 GHz) - L <sub>INS</sub> (2.15 GHz)	-	0.7	3.0	dB
Isolation D/U-ratio1 <sup>Note 1</sup>	ISL1	f = 0.25 to 0.95 GHz	28	34	-	dB
Isolation D/U-ratio2 <sup>Note 1</sup>	ISL2	f = 0.95 to 2.15 GHz	25	29	-	dB
Output Return Loss	RL <sub>out</sub>	f = 0.25 to 2.15 GHz	10	13	-	dB
Control Current <sup>Note 2</sup>	I <sub>CONT</sub>	V <sub>DD</sub> = +3.3 V, V <sub>CONT</sub> = +3.3 V/0 V, non-RF	-	0.01	1	μA
Supply Current	I <sub>DD</sub>	V <sub>DD</sub> = +3.3 V, V <sub>CONT</sub> = +3.3 V/0 V, non-RF	-	0.01	1	μA

**Notes 1.** Isolation Desire Un-desire (D/U)-ratio = |(Signal leakage (off-state)) - (Insertion loss (on-state))|

**2.** Per 1 control pin

PIN CONNECTIONS

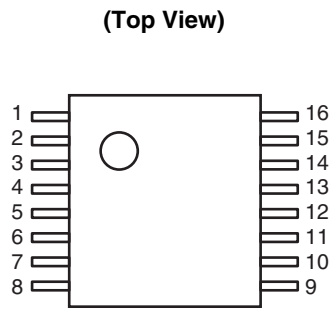

Pin No.	Pin Name	Pin No.	Pin Name
1	IN-C	16	IN-B
2	GND	15	GND
3	IN-D	14	IN-A
4	GND	13	GND
5	GND	12	V <sub>DD</sub>
6	OUT2	11	OUT1
7	V <sub>CONT3</sub>	10	V <sub>CONT1</sub>
8	V <sub>CONT4</sub>	9	V <sub>CONT2</sub>

**Remark** Back side. : GND

TRUTH TABLE

State		Output Signal		Control Pins			
No.	Mode	OUT1	OUT2	V <sub>CONT1</sub>	V <sub>CONT2</sub>	V <sub>CONT3</sub>	V <sub>CONT4</sub>
1	AA	IN-A	IN-A	Low	Low	Low	Low
2	AB		IN-B	Low	Low	Low	High
3	AC		IN-C	Low	Low	High	Low
4	AD		IN-D	Low	Low	High	High
5	BA	IN-B	IN-A	Low	High	Low	Low
6	BB		IN-B	Low	High	Low	High
7	BC		IN-C	Low	High	High	Low
8	BD		IN-D	Low	High	High	High
9	CA	IN-C	IN-A	High	Low	Low	Low
10	CB		IN-B	High	Low	Low	High
11	CC		IN-C	High	Low	High	Low
12	CD		IN-D	High	Low	High	High
13	DA	IN-D	IN-A	High	High	Low	Low
14	DB		IN-B	High	High	Low	High
15	DC		IN-C	High	High	High	Low
16	DD		IN-D	High	High	High	High

Remark High : +3.3 Vdc, Low : 0 Vdc

FUNCTIONAL DIAGRAM

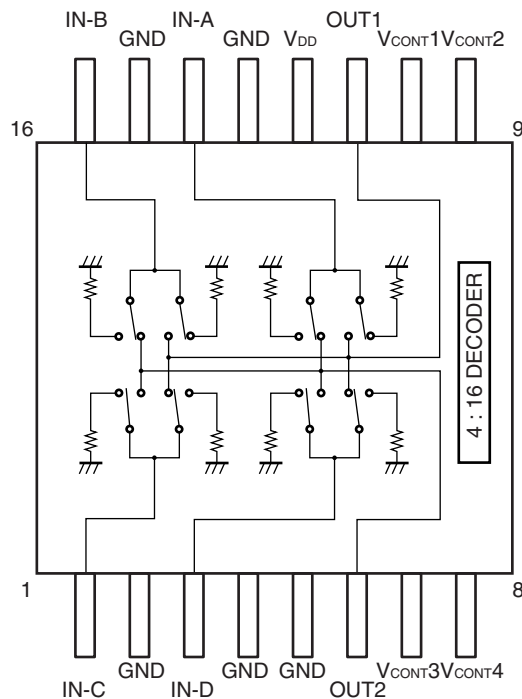

Remark Back Side : GND

**EVALUATION CIRCUIT** ( $V_{DD} = +3.3\text{ V}$ ,  $V_{CONT1}$  to  $V_{CONT4} = 0\text{ V}/+3.3\text{ V}$ ,  $P_{in} = 0\text{ dBm}$ ,  $Z_o = 50\ \Omega$ , DC Blocking Capacitor =  $1\ 000\ \text{pF}$ )

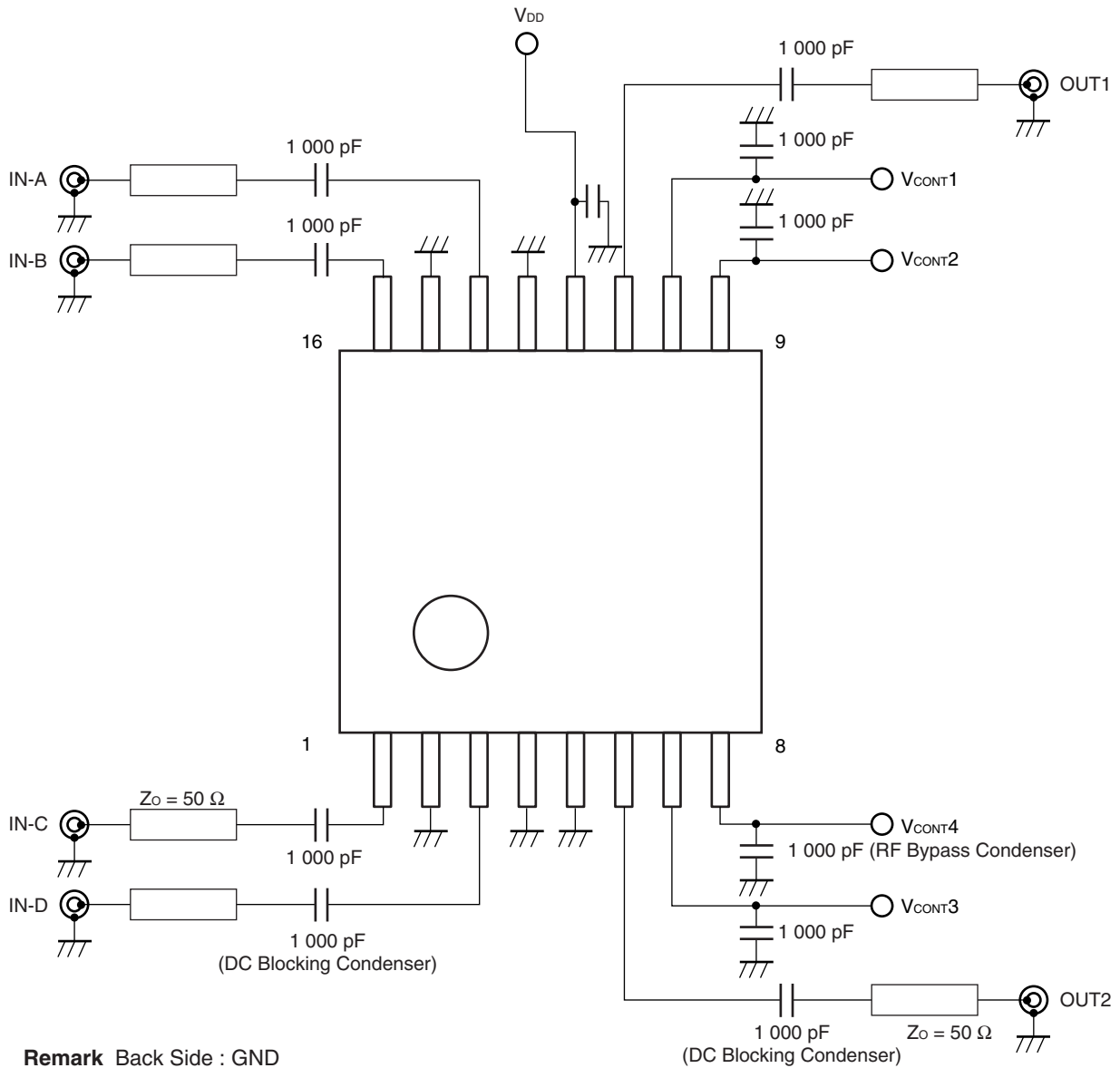

The application circuits and their parameters are for reference only and are not intended for use in actual design-ins.

ILLUSTRATION OF THE TEST CIRCUIT ASSEMBLED ON EVALUATION BOARD

(Top View)

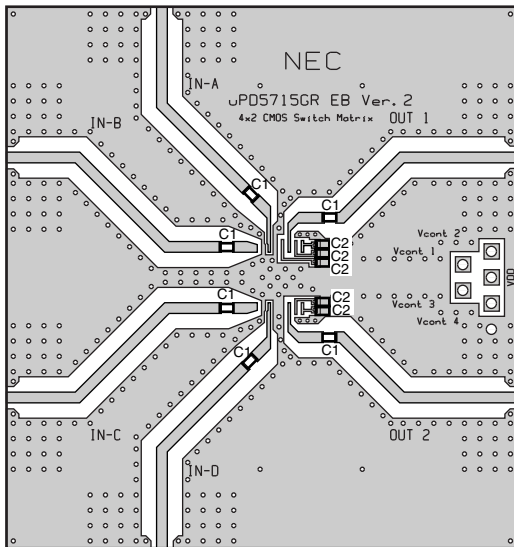

(Bottom View)

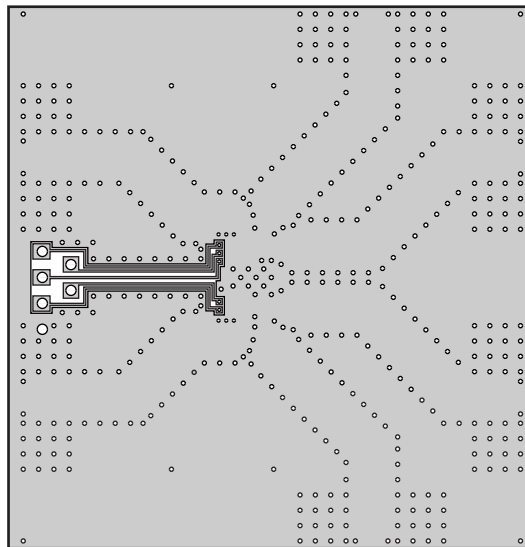

**Notes**

1. 50 × 53 × 0.51 mm double sided copper clad RO4003 (Rogers) board ( $\epsilon_r = 3.38$ ).
2. Au plated on pattern
3.  $\circ$   $\bigcirc$ : Through holes
4. C1, C2: 1 000 pF

**TYPICAL CHARACTERISTICS**

( $T_A = +25^\circ\text{C}$ ,  $V_{DD} = +3.3\text{ V}$ ,  $V_{CONT} = 0\text{ V}/+3.3\text{ V}$ ,  $P_{in} = 0\text{ dBm}$ ,  $Z_o = 50\ \Omega$ , unless otherwise specified)

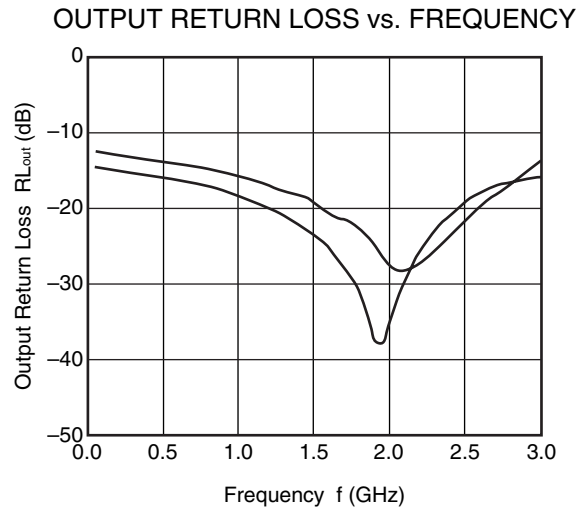
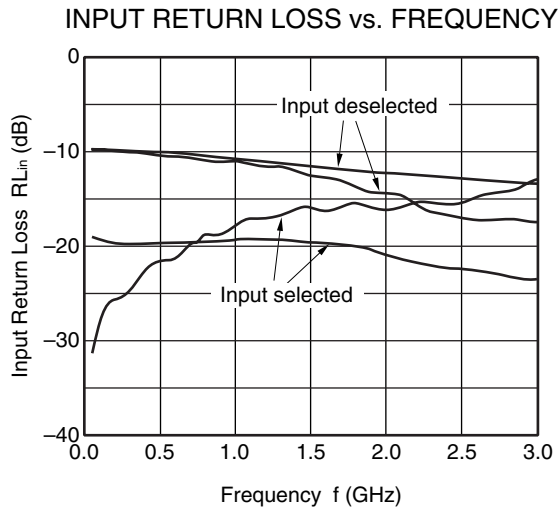
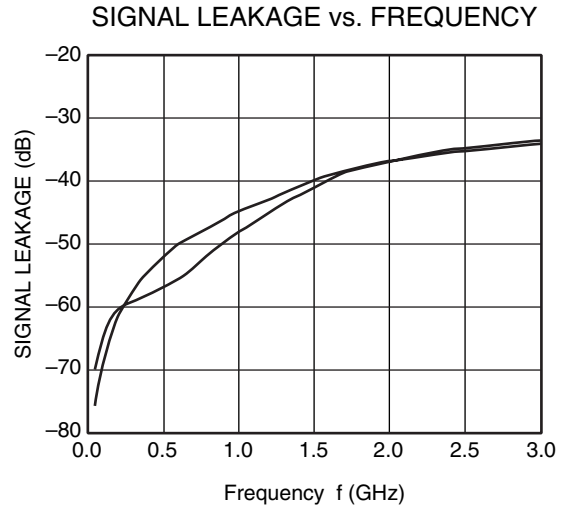
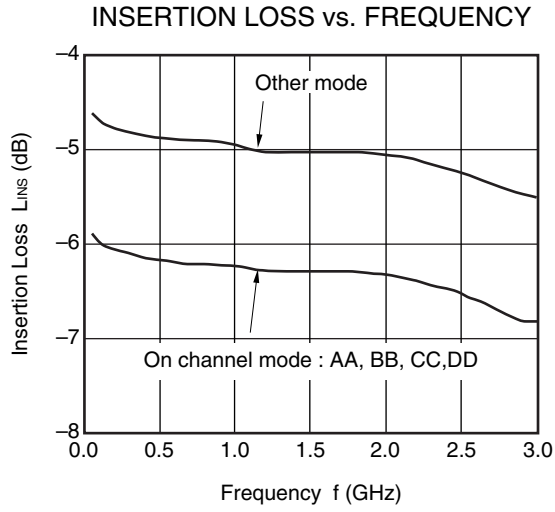

**Remark** The graphs indicate nominal characteristics.

INSERTION LOSS vs.  
ON CHANNEL MODE

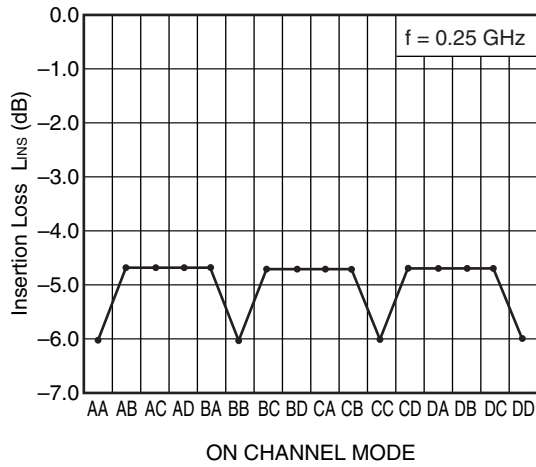

INSERTION LOSS vs.  
ON CHANNEL MODE

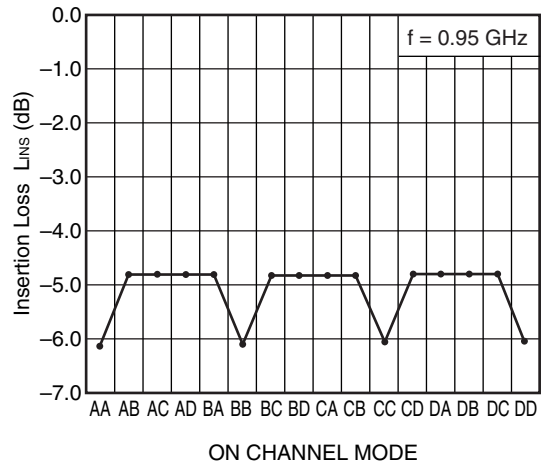

INSERTION LOSS vs.  
ON CHANNEL MODE

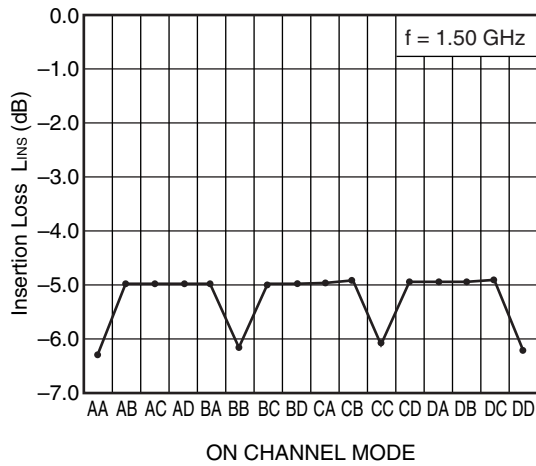

INSERTION LOSS vs.  
ON CHANNEL MODE

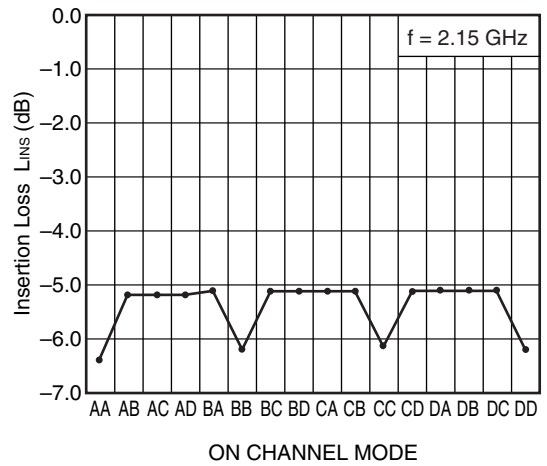

**Remark** The graphs indicate nominal characteristics.



ISOLATION D/U-RATIO  
vs. ON CHANNEL MODE

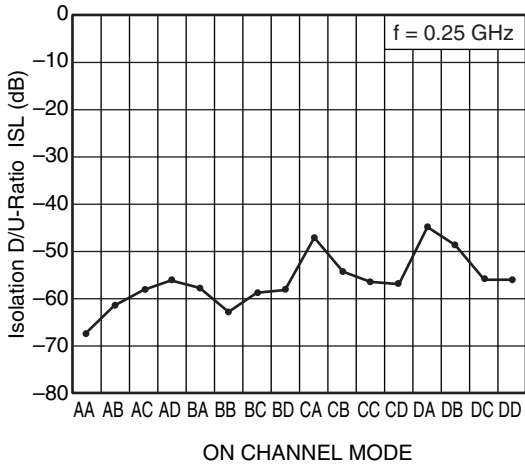

ISOLATION D/U-RATIO  
vs. ON CHANNEL MODE

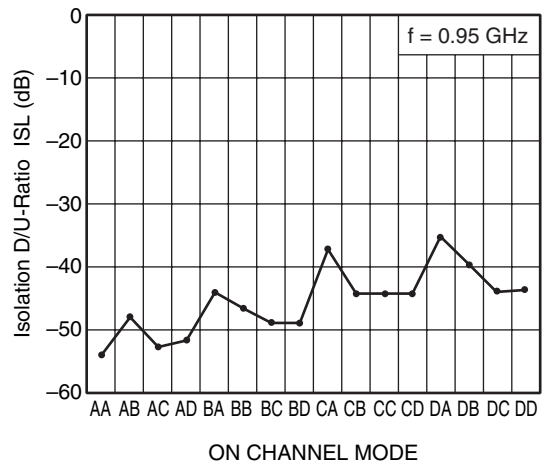

ISOLATION D/U-RATIO  
vs. ON CHANNEL MODE

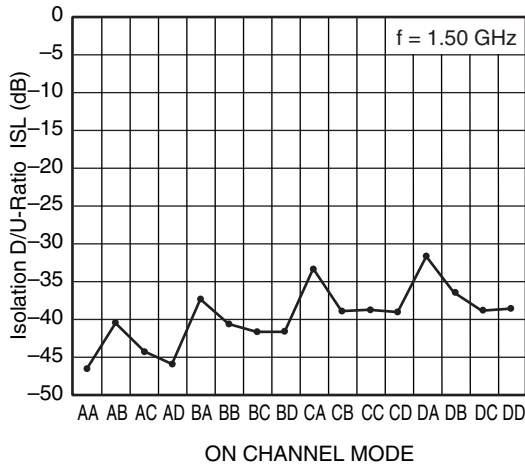

ISOLATION D/U-RATIO  
vs. ON CHANNEL MODE

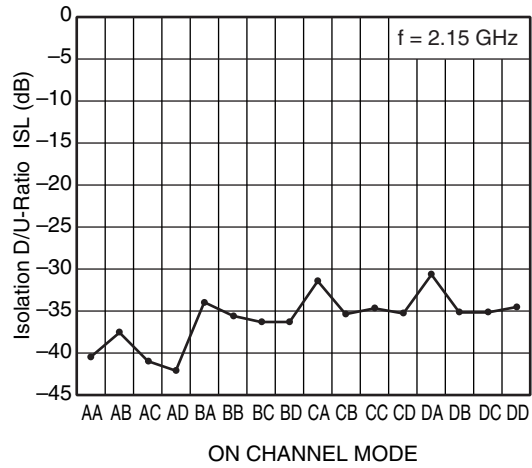

**Remark** The graphs indicate nominal characteristics.

OUTPUT RETURN LOSS  
vs. ON CHANNEL MODE

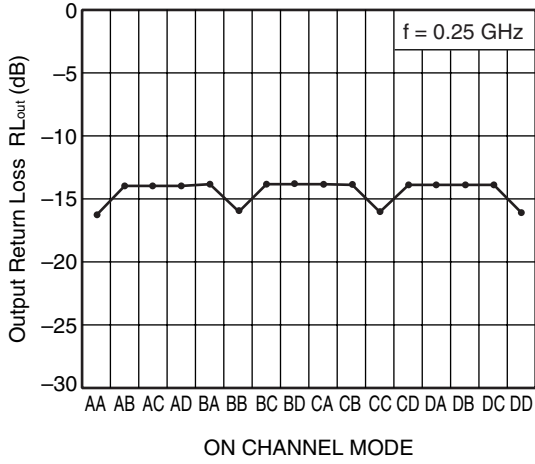

OUTPUT RETURN LOSS  
vs. ON CHANNEL MODE

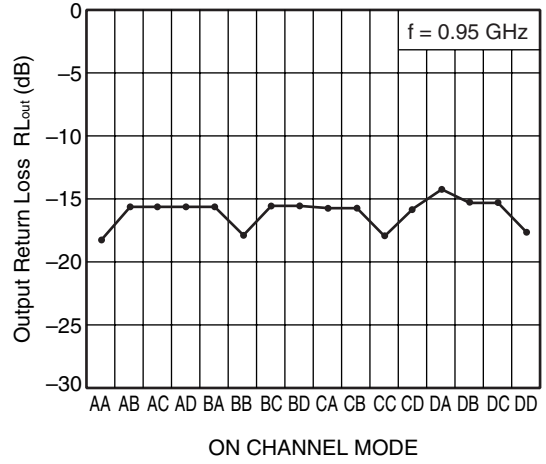

OUTPUT RETURN LOSS  
vs. ON CHANNEL MODE

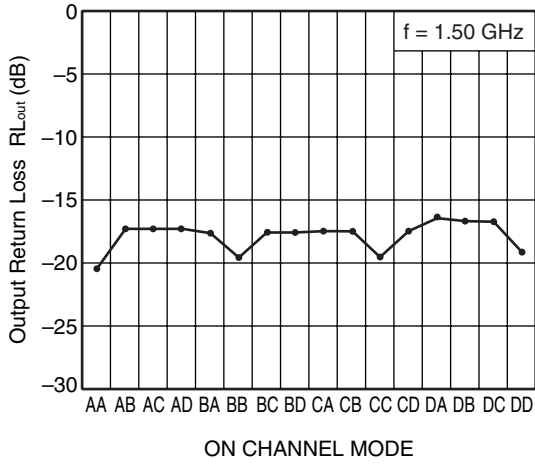

OUTPUT RETURN LOSS  
vs. ON CHANNEL MODE

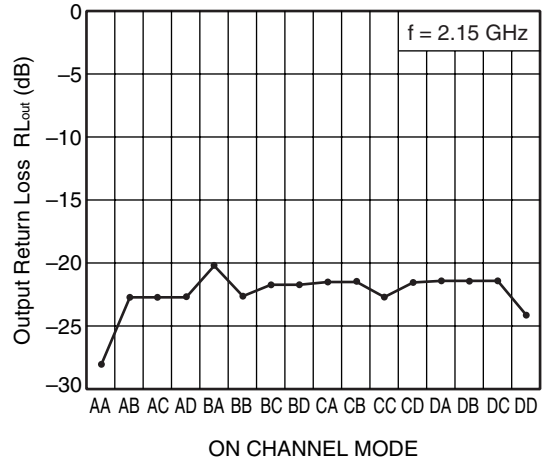

**Remark** The graphs indicate nominal characteristics.

PACKAGE DIMENSIONS

16-PIN PLASTIC HTSSOP (UNIT: mm)

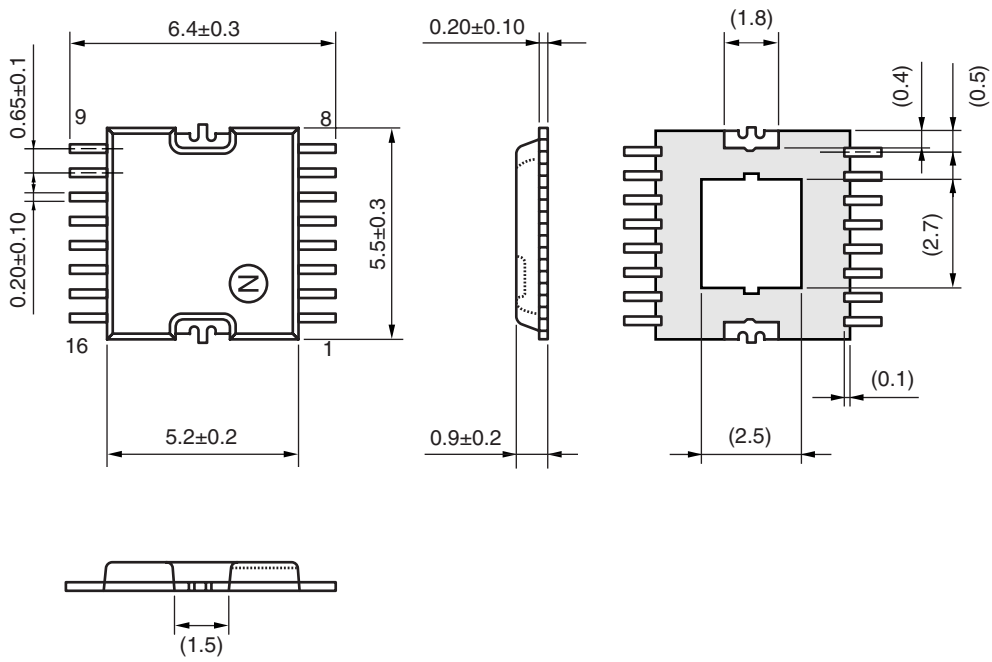

**RECOMMENDED SOLDERING CONDITIONS**

This product should be soldered and mounted under the following recommended conditions. For soldering methods and conditions other than those recommended below, contact your nearby sales office.

Soldering Method	Soldering Conditions	Condition Symbol	
Infrared Reflow	Peak temperature (package surface temperature)	: 260°C or below	IR260
	Time at peak temperature	: 10 seconds or less	
	Time at temperature of 220°C or higher	: 60 seconds or less	
	Preheating time at 120 to 180°C	: 120±30 seconds	
	Maximum number of reflow processes	: 3 times	
	Maximum chlorine content of rosin flux (% mass)	: 0.2%(Wt.) or below	
Partial Heating	Peak temperature (terminal temperature)	: 350°C or below	HS350
	Soldering time (per side of device)	: 3 seconds or less	
	Maximum chlorine content of rosin flux (% mass)	: 0.2%(Wt.) or below	

**Caution Do not use different soldering methods together (except for partial heating).**

- **The information in this document is current as of May, 2006. The information is subject to change without notice. For actual design-in, refer to the latest publications of NEC Electronics data sheets or data books, etc., for the most up-to-date specifications of NEC Electronics products. Not all products and/or types are available in every country. Please check with an NEC Electronics sales representative for availability and additional information.**

- No part of this document may be copied or reproduced in any form or by any means without the prior written consent of NEC Electronics. NEC Electronics assumes no responsibility for any errors that may appear in this document.
- NEC Electronics does not assume any liability for infringement of patents, copyrights or other intellectual property rights of third parties by or arising from the use of NEC Electronics products listed in this document or any other liability arising from the use of such products. No license, express, implied or otherwise, is granted under any patents, copyrights or other intellectual property rights of NEC Electronics or others.
- Descriptions of circuits, software and other related information in this document are provided for illustrative purposes in semiconductor product operation and application examples. The incorporation of these circuits, software and information in the design of a customer's equipment shall be done under the full responsibility of the customer. NEC Electronics assumes no responsibility for any losses incurred by customers or third parties arising from the use of these circuits, software and information.
- While NEC Electronics endeavors to enhance the quality, reliability and safety of NEC Electronics products, customers agree and acknowledge that the possibility of defects thereof cannot be eliminated entirely. To minimize risks of damage to property or injury (including death) to persons arising from defects in NEC Electronics products, customers must incorporate sufficient safety measures in their design, such as redundancy, fire-containment and anti-failure features.
- NEC Electronics products are classified into the following three quality grades: "Standard", "Special" and "Specific".

The "Specific" quality grade applies only to NEC Electronics products developed based on a customer-designated "quality assurance program" for a specific application. The recommended applications of an NEC Electronics product depend on its quality grade, as indicated below. Customers must check the quality grade of each NEC Electronics product before using it in a particular application.

"Standard": Computers, office equipment, communications equipment, test and measurement equipment, audio and visual equipment, home electronic appliances, machine tools, personal electronic equipment and industrial robots.

"Special": Transportation equipment (automobiles, trains, ships, etc.), traffic control systems, anti-disaster systems, anti-crime systems, safety equipment and medical equipment (not specifically designed for life support).

"Specific": Aircraft, aerospace equipment, submersible repeaters, nuclear reactor control systems, life support systems and medical equipment for life support, etc.

The quality grade of NEC Electronics products is "Standard" unless otherwise expressly specified in NEC Electronics data sheets or data books, etc. If customers wish to use NEC Electronics products in applications not intended by NEC Electronics, they must contact an NEC Electronics sales representative in advance to determine NEC Electronics' willingness to support a given application.

(Note)

- (1) "NEC Electronics" as used in this statement means NEC Electronics Corporation and also includes its majority-owned subsidiaries.
- (2) "NEC Electronics products" means any product developed or manufactured by or for NEC Electronics (as defined above).

M8E 02.11-1

---

► For further information, please contact

**NEC Compound Semiconductor Devices Hong Kong Limited**

E-mail: [contact@ncsd-hk.necel.com](mailto:contact@ncsd-hk.necel.com)

Hong Kong Head Office TEL: +852-3107-7303 FAX: +852-3107-7309

Taipei Branch Office TEL: +886-2-8712-0478 FAX: +886-2-2545-3859

Korea Branch Office TEL: +82-2-558-2120 FAX: +82-2-558-5209

**NEC Electronics (Europe) GmbH** <http://www.eu.necel.com/>

TEL: +49-211-6503-0 FAX: +49-211-6503-1327

**California Eastern Laboratories, Inc.** <http://www.cel.com/>

TEL: +1-408-988-3500 FAX: +1-408-988-0279

**Compound Semiconductor Devices Division**

**NEC Electronics Corporation**

URL: <http://www.ncsd.necel.com/>