

ST 2SC4375U

NPN Silicon Epitaxial Planar Transistor

High current application

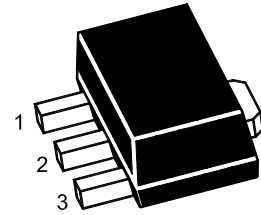

1.Base 2.Collector 3.Emitter
SOT-89 Plastic Package

Absolute Maximum Ratings ($T_a = 25\text{ }^\circ\text{C}$)

Parameter	Symbol	Value	Unit
Collector Base Voltage	V_{CBO}	30	V
Collector Emitter Voltage	V_{CEO}	30	V
Emitter Base Voltage	V_{EBO}	5	V
Collector Current	I_C	1.5	A
Total Power Dissipation	P_{tot}	0.5 1 ¹⁾	W
Junction Temperature	T_J	150	$^\circ\text{C}$
Storage Temperature Range	T_S	- 55 to + 150	$^\circ\text{C}$

¹⁾ When mounted on a 250 mm² X 0.8 t ceramic substrate.

Characteristics at $T_a = 25\text{ }^\circ\text{C}$

Parameter	Symbol	Min.	Typ.	Max.	Unit	
DC Current Gain at $V_{CE} = 2\text{ V}$, $I_C = 500\text{ mA}$	Current Gain Group O	h_{FE}	100	-	200	-
	Y	h_{FE}	160	-	320	-
Collector Base Breakdown Voltage at $I_C = 1\text{ mA}$	$V_{(BR)CBO}$	30	-	-	V	
Collector Emitter Breakdown Voltage at $I_C = 10\text{ mA}$	$V_{(BR)CEO}$	30	-	-	V	
Emitter Base Breakdown Voltage at $I_E = 1\text{ mA}$	$V_{(BR)EBO}$	5	-	-	V	
Collector Cutoff Current at $V_{CB} = 30\text{ V}$	I_{CBO}	-	-	100	nA	
Emitter Cutoff Current at $V_{EB} = 5\text{ V}$	I_{EBO}	-	-	100	nA	
Collector Emitter Saturation Voltage at $I_C = 1.5\text{ A}$, $I_B = 30\text{ mA}$	$V_{CE(sat)}$	-	-	2	V	
Base Emitter Voltage at $V_{CE} = 2\text{ V}$, $I_C = 500\text{ mA}$	V_{BE}	-	-	1	V	
Transition Frequency at $V_{CE} = 2\text{ V}$, $I_C = 500\text{ mA}$	f_T	-	120	-	MHz	
Collector Output Capacitance at $V_{CB} = 10\text{ V}$, $f = 1\text{ MHz}$	C_{ob}	-	-	40	pF	

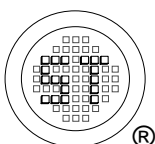

SEMTECH ELECTRONICS LTD.

(Subsidiary of Sino-Tech International Holdings Limited, a company listed on the Hong Kong Stock Exchange, Stock Code: 724)

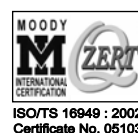

Dated : 17/04/2007

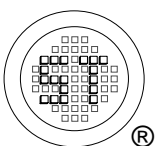
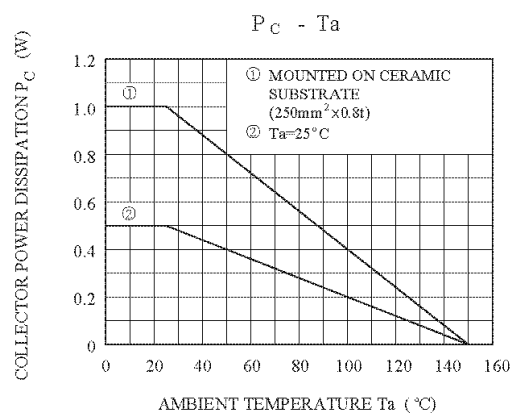
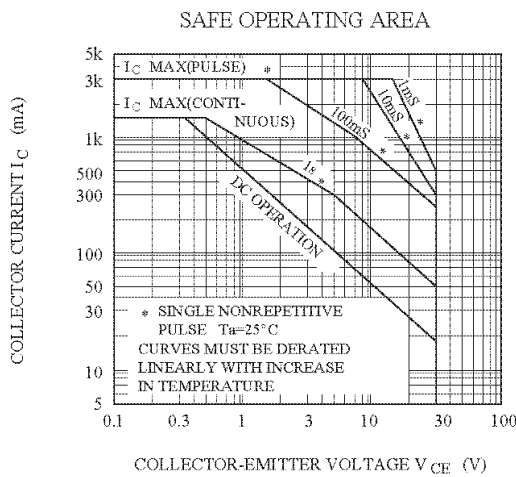
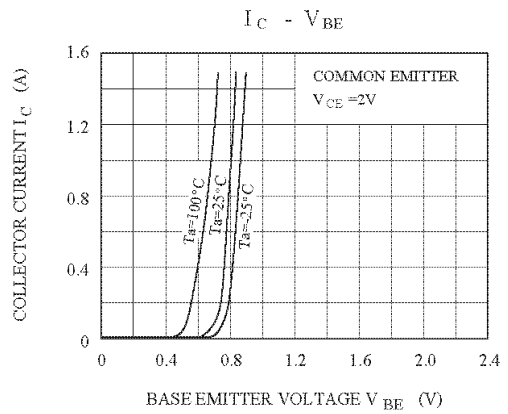
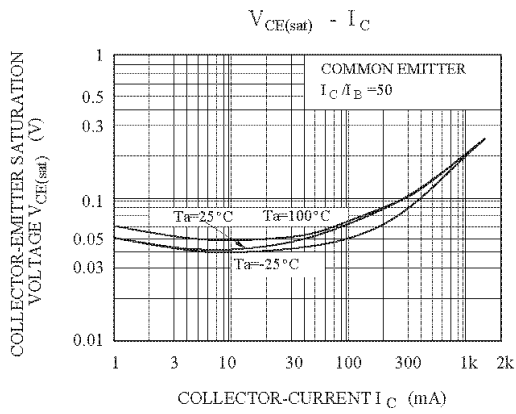
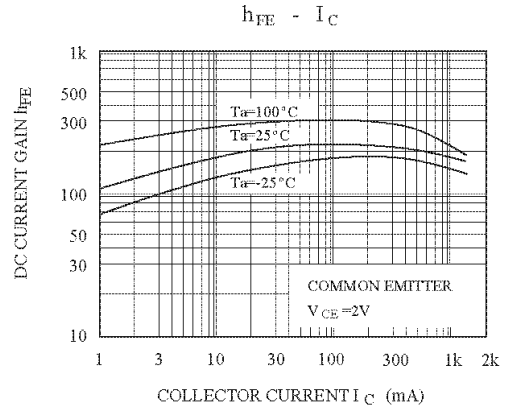
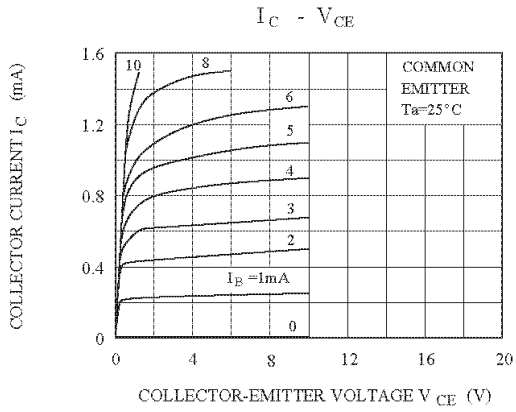

SEMTECH ELECTRONICS LTD.

(Subsidiary of Sino-Tech International Holdings Limited, a company listed on the Hong Kong Stock Exchange, Stock Code: 724)



ISO/TS 16949 : 2002
Certificate No. 05103



ISO 14001:2004
Certificate No. 71116



ISO 9001:2000
Certificate No. 0506098

ST 2SC4375U

SOT-89 PACKAGE OUTLINE

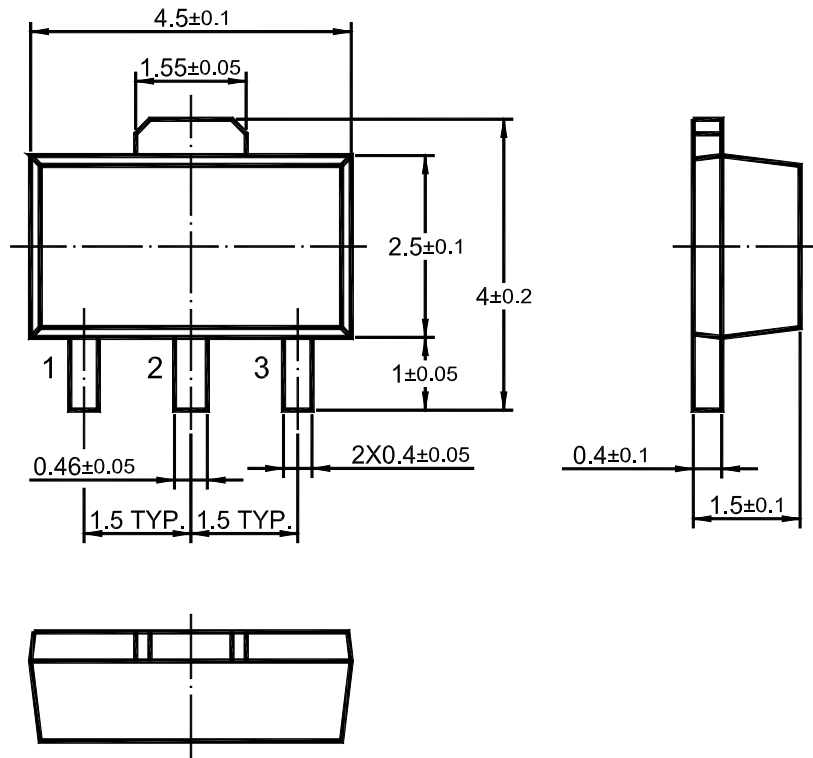

Dimensions in mm

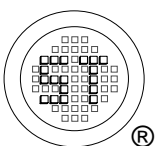

SEMTECH ELECTRONICS LTD.
(Subsidiary of Sino-Tech International Holdings Limited, a company listed on the Hong Kong Stock Exchange, Stock Code: 724)



Dated : 17/04/2007