

## Round LED lamp

BL-L413

### ■ Features:

- 4.0mm Round Type LED lamp
- Ultra brightness.
- Choice of various viewing angles.
- Diffused, Transparent and Water clear lens
- IC compatible /Low current capability.
- RoHs Compliance



### ■ Electrical-optical characteristics: (Ta=25°C) (Test Condition: IF=20mA)

Part Number	Chip			Lens Type	Forward Voltage(VF) Unit:V		Luminous Intensity (Iv) Unit:mcd		Viewing Angle 2θ1/2 (deg)
	Emitted Color	Material	λ <sub>P</sub> (nm)		Typ	Max	Min.	Typ.	
					BL-L413SRC	Hi Red	AlGaAs,SH	660	
BL-L413LRC	Super Red	AlGaAs,DH	660	1.85	2.20	250	700		
BL-L413URC	Ultra Red	AlGaAs,DDH	660	1.95	2.20	550	1000		
BL-L413UEC	Ultra Orange	AlGaInP	630	2.10	2.50	900	1900		
BL-L413UYC	Ultra Yellow	AlGaInP	590	2.10	2.50	900	2100		
BL-L413UGC	Ultra Green	AlGaInP	574	2.20	2.50	220	650		
BL-L413PGC	Ultra Pure Green	InGaN	525	3.80	4.50	1200	4000		
BL-L413BGC	Ultra Bluish Green	InGaN	505	3.80	4.50	900	3500		
BL-L413BC	Blue	InGaN	430	3.80	4.50	400	1000		
BL-L413UBC	Ultra Blue	InGaN	470	2.70	4.20	500	4000		
BL-L413VC	UV	InGaN	405	3.80	4.50	100	160		
BL-L413UWC	Ultra White	InGaN	/	2.70	4.20	3000	10000		

### ■ Absolute maximum ratings (Ta=25°C)

Parameter	SR	LR	UR	UE	UY	UG	PG	BG	B	UB	UV	W	Unit
Forward Current I <sub>F</sub>	25	25	25	30	30	30	30	30	30	30	30	30	mA
Power Dissipation P <sub>d</sub>	60	60	60	65	65	75	110	110	120	120	120	120	mW
Reverse Voltage V <sub>R</sub>	5	5	5	5	5	5	5	5	5	5	5	5	V
Peak Forward Current I <sub>PF</sub> (Duty 1/10 @1KHZ)	150	150	150	150	150	150	150	100	100	100	100	100	mA
Operation Temperature T <sub>OPR</sub>	-40 to +80												°C
Storage Temperature T <sub>STG</sub>	-40 to +85												°C
Lead Soldering Temperature TSOL	Max.260±5°C for 3 sec Max. (1.6mm from the base of the epoxy bulb)												°C

Round LED lamp

BL-L413

■ Package configuration & Internal circuit diagram

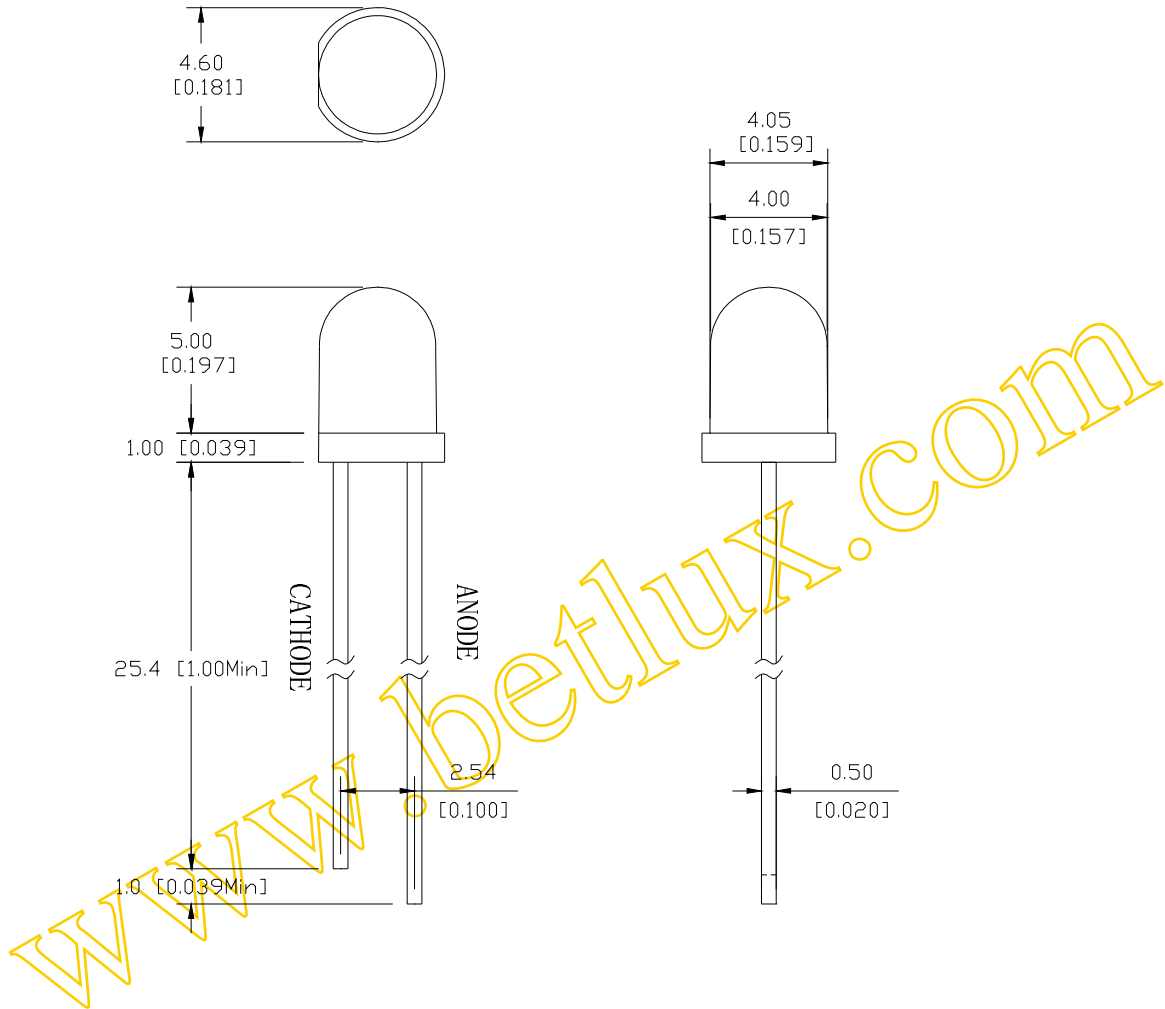

Notes:

1. All dimensions are in millimeters (inches)
2. Tolerance is  $\pm 0.25(0.01)$  unless otherwise noted.
3. Specifications are subject to change without notice.

## Round LED lamp

BL-L413

### Typical electrical-optical characteristics curves:

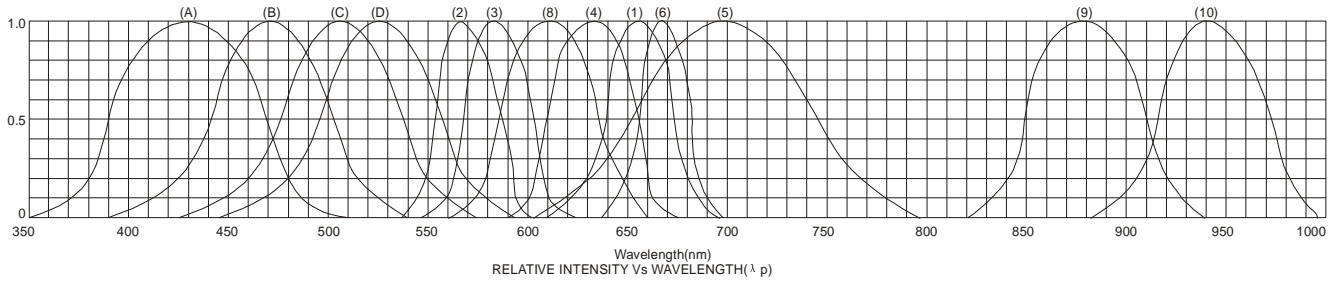

- |   |                                      |
|---|--------------------------------------|
| (1) - GaAsP/GaAs 655nm/Red                | (9) - GaAlAs 880nm                   |
| (2) - GaP 570nm/Yellow Green              | (10) - GaAs/GaAs & GaAlAs/GaAs 940nm |
| (3) - GaAsP/GaP 585nm/Yellow              | (A) - GaN/SiC 430nm/Blue             |
| (4) - GaAsP/GaP 635nm/Orange & Hi-Eff Red | (B) - InGaN/SiC 470nm/Blue           |
| (5) - GaP 700nm/Bright Red                | (C) - InGaN/SiC 505nm/Ultra Green    |
| (6) - GaAlAs/GaAs 660nm/Super Red         | (D) - InGaN/SiC 525nm/Ultra Green    |
| (8) - GaAsP/GaP 610nm/Super Red           |                                      |

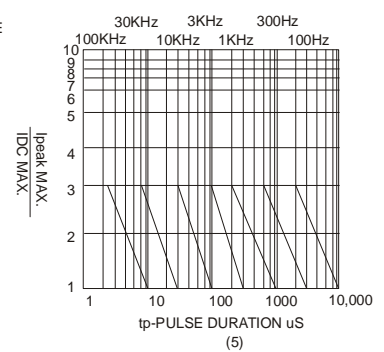
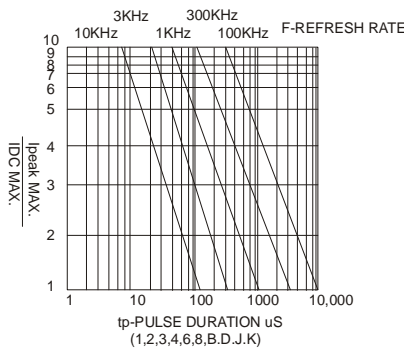
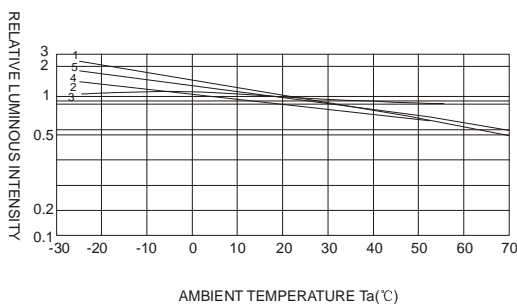
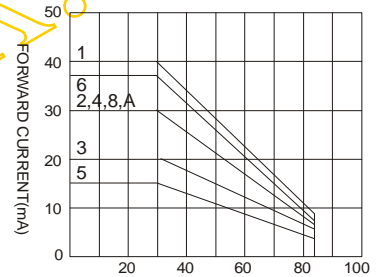
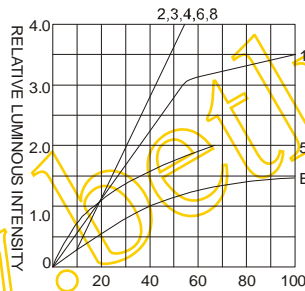
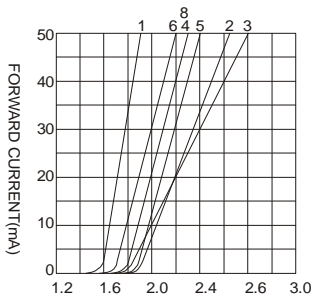

NOTE:25°C free air temperature unless otherwise specified