

1. PART NO. EXPRESSION :

SSB0705101MZ F

(a) (b) (c) (d)(e)(f)

- (a) Series code
- (b) Dimension code
- (c) Inductance code : 101 = 100uH
- (d) Tolerance code : M = ±20%
- (e) X, Y, Z : Standard part
- (f) F : Lead Free

2. CONFIGURATION & DIMENSIONS :

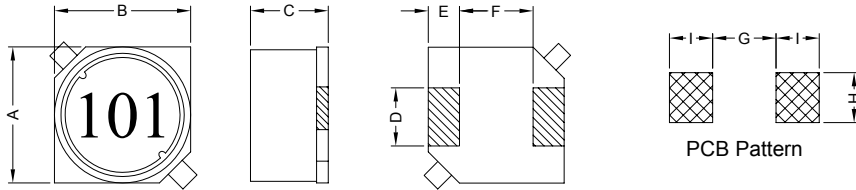

Unit:m/m

A	B	C	D	E	F	G	H	I
7.0±0.3	7.0±0.3	4.6±0.3	2.0±0.2	1.5±0.2	4.0±0.2	3.7 Ref.	2.2 Ref.	1.9 Ref.

3. SCHEMATIC :

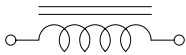

4. MATERIALS :

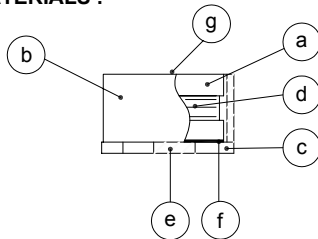

- (a) Core : DR Ferrite Core
- (b) Core : RI Ferrite Core
- (c) Base : LCP
- (d) Wire : Enamelled Copper Wire
- (e) Terminal : Tinned Copper Plate
- (f) Adhesive : Epoxy
- (g) Ink : Bon Margue

5. GENERAL SPECIFICATION :

- a) Temp. rise : 40°C Max.
- b) Rated current : Base on temp. rise & $\Delta L/L0A = 10\%$ Max.
- c) Storage temp. : -40°C to +125°C
- d) Operating temp. : -40°C to +85°C
- e) Resistance to solder heat : 260°C.10 secs



RoHS Compliant

NOTE : Specifications subject to change without notice. Please check our website for latest information.

18.04.2008



SUPERWORLD ELECTRONICS (S) PTE LTD

6. ELECTRICAL CHARACTERISTICS :

Part No.	Inductance (μ H)	Test Frequency (Hz)	RDC (m Ω) Max.	IDC (A) Max.
SSB07051R0MZF	1.0 \pm 20%	1V/ 100K	20	3.00
SSB07051R5MZF	1.5 \pm 20%	1V/ 100K	23	2.90
SSB07052R2MZF	2.2 \pm 20%	1V/ 100K	26	2.70
SSB07053R3MZF	3.3 \pm 20%	1V/ 100K	30	2.50
SSB07054R7MZF	4.7 \pm 20%	1V/ 100K	36	2.00
SSB07056R8MZF	6.8 \pm 20%	1V/ 100K	45	1.90
SSB0705100MZF	10.0 \pm 20%	1V/ 100K	60	1.70
SSB0705120MZF	12.0 \pm 20%	1V/ 100K	65	1.55
SSB0705150MZF	15.0 \pm 20%	1V/ 100K	70	1.45
SSB0705180MZF	18.0 \pm 20%	1V/ 100K	80	1.20
SSB0705220MZF	22.0 \pm 20%	1V/ 100K	90	1.15
SSB0705270MZF	27.0 \pm 20%	1V/ 100K	120	1.00
SSB0705330MZF	33.0 \pm 20%	1V/ 100K	135	0.90
SSB0705390MZF	39.0 \pm 20%	1V/ 100K	150	0.85
SSB0705470MZF	47.0 \pm 20%	1V/ 100K	170	0.80
SSB0705560MZF	56.0 \pm 20%	1V/ 100K	230	0.70
SSB0705680MZF	68.0 \pm 20%	1V/ 100K	270	0.65
SSB0705820MZF	82.0 \pm 20%	1V/ 100K	300	0.57
SSB0705101MZF	100.0 \pm 20%	1V / 100K	360	0.50
SSB0705121MZF	120.0 \pm 20%	1V / 100K	400	0.47
SSB0705151MZF	150.0 \pm 20%	1V / 100K	530	0.40
SSB0705181MZF	180.0 \pm 20%	1V / 100K	600	0.38
SSB0705221MZF	220.0 \pm 20%	1V / 100K	800	0.35
SSB0705271MZF	270.0 \pm 20%	1V / 100K	900	0.32
SSB0705331MZF	330.0 \pm 20%	1V / 100K	1000	0.30
SSB0705391MZF	390.0 \pm 20%	1V / 100K	1400	0.27
SSB0705471MZF	470.0 \pm 20%	1V / 100K	1600	0.25
SSB0705561MZF	560.0 \pm 20%	1V / 100K	1750	0.22
SSB0705681MZF	680.0 \pm 20%	1V / 100K	2500	0.20
SSB0705821MZF	820.0 \pm 20%	1V / 100K	2800	0.19
SSB0705102MZF	1000.0 \pm 20%	1V / 100K	3200	0.18



RoHS Compliant

NOTE : Specifications subject to change without notice. Please check our website for latest information.

18.04.2008



SUPERWORLD ELECTRONICS (S) PTE LTD

PG. 2

7. CHARACTERISTICS CURVES :

@ TEMP. RISE VS. DC SUPERPOSITION RESPONSE CURVE

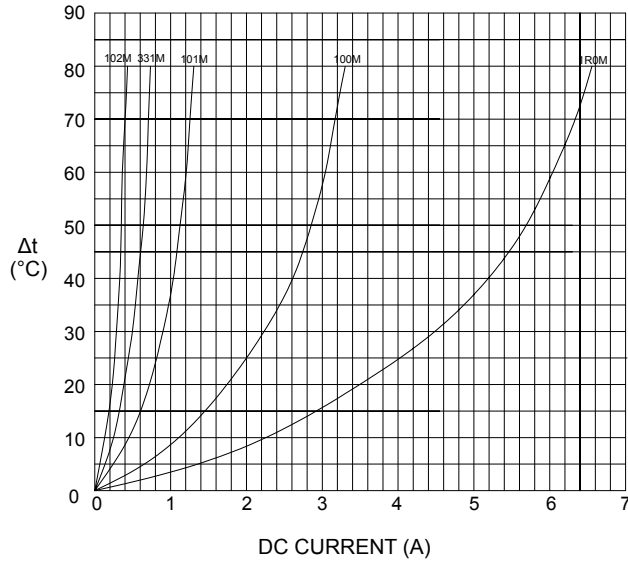

@ INDUCTANCE VS. FREQUENCY RESPONSE CURVE

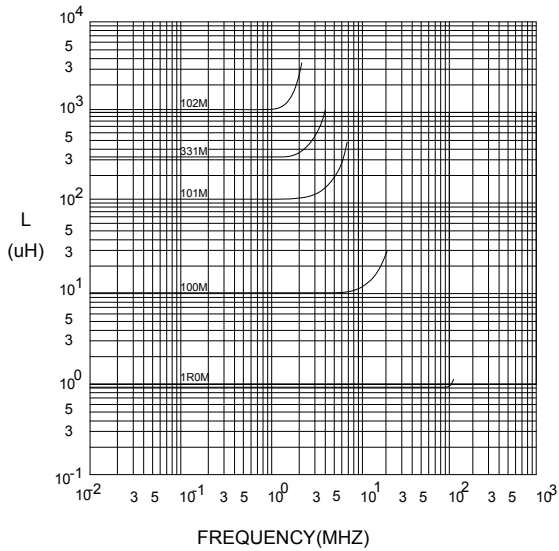

@ INDUCTANCE VS. DC SUPERPOSITION RESPONSE CURVE

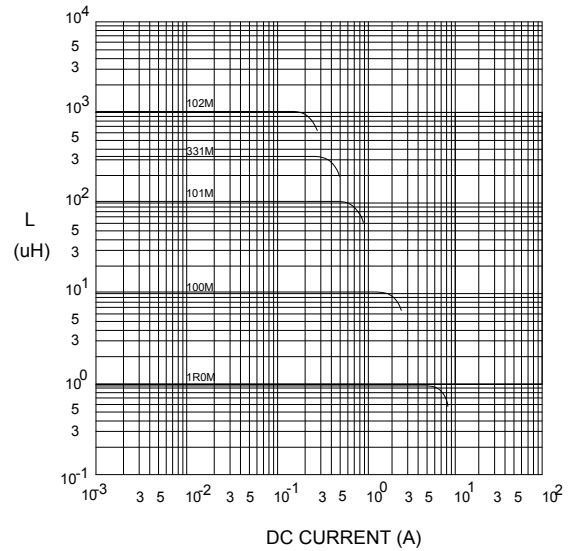

RoHS Compliant

NOTE : Specifications subject to change without notice. Please check our website for latest information.

18.04.2008



SUPERWORLD ELECTRONICS (S) PTE LTD

RECOMMENDED SOLDERING CONDITIONS REFLOW SOLDERINGS

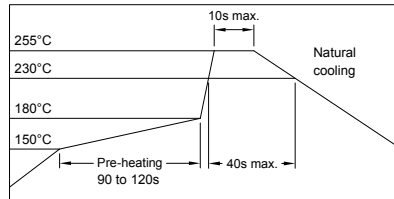

8. PACKAGING INFORMATION :

(1) CONFIGURATION

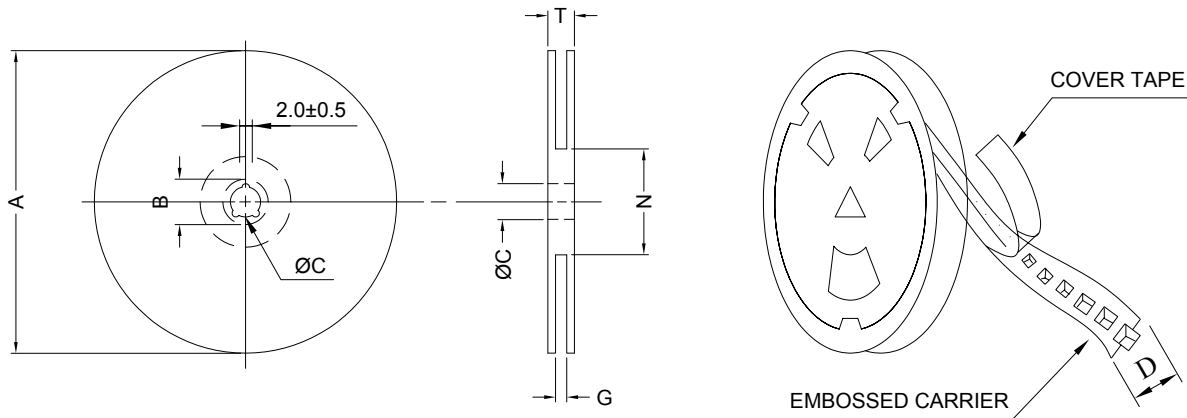

* CARRIER TAPE WIDTH : D

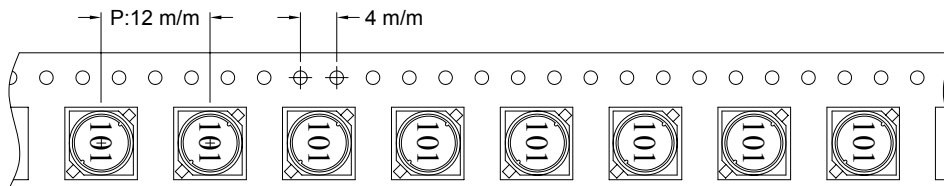

(2) DIMENSIONS

Unit:m/m

STYLE	A	B	C	D	G	N	T
13-16	330	21±0.8	13	16	18 ⁺⁰	50 ⁻⁰	22.4

(3) Q'TY & G.W. PER PACKAGE

SERIES	INNER : REEL			OUTER : CARTON		
	Q'TY (PCS)	G.W. (gw)	STYLE	Q'TY (PCS)	G.W. (Kg)	SIZE (cm)
SSB0705	1000	717	13-16	6000	7.9	40 x 40 x 24



RoHS Compliant

NOTE : Specifications subject to change without notice. Please check our website for latest information.

18.04.2008



SUPERWORLD ELECTRONICS (S) PTE LTD

9. RELIABILITY AND TEST CONDITION :

TEST ITEM	SPECIFICATION	TEST CONDITION
SOLDERABILITY	MORE THAN 90% OF THE TERMINAL ELECTRODE SHALL BE COVERED WITH FRESH SOLDER.	PREHEAT : 125±25°C FOR 60 SECONDS SOLDER : 99%Sn/0.3%Ag/0.7%Cu or equivalent SOLDER TEMP. : 245±5°C FLUX : ROSIN DIP TIME : 4±1 SECONDS
THERMAL SHOCK TEST (TEMP. CYCLE)	INDUCTANCE SHALL NOT CHANGE MORE THAN ±20%	ROOM TEMP. → -25±2°C 15 MINUTES → 30 MINUTES ROOM TEMP. → 85±2°C 15 MINUTES → 30 MINUTES TOTAL : 50 CYCLES
HUMIDITY RESISTANCE TEST		TEMPERATURE : 40±2°C HUMIDITY : 90 ~ 95% APPLIED CURRENT : PER SPEC. TIME : 500 HOURS
HIGH TEMP. RESISTANCE TEST		TEMPERATURE : 85±2°C APPLIED CURRENT : PER SPEC. TIME : 500 HOURS



RoHS Compliant

NOTE : Specifications subject to change without notice. Please check our website for latest information.

18.04.2008



SUPERWORLD ELECTRONICS (S) PTE LTD

10. UL CARD :

OBMW2 **November 30, 2000**
Magnet Wire - Component
PACIFIC ELECTRIC WIRE & CABLE (SHENZHEN) CO LTD **E201757**
607 BAOLONG INDUSTRIAL ESTATE LONGGANG, SHENZHEN
GUANGDONG CHINA

Mtl Dsg	BC	Coating Type	TC	ANSI Type	TI
UEW/U		Polyurethane	—	—	130
PEW/U		Polyester	—	MW5-C	155°C
PEWH/U		Modified Polyester	—	MW30-C	180
PEW-NY/U		Polyester	Polyamide	MW24-C	155
HAI/U		Polyester(Amide)(Imide)	Polyamideimide	MW35,73	200
UEW-NY/U		Polyurethane	Polyamide	MW80-C	155
				MW28-C	130

Marking: Company name and material designation or marked designation on package or reel, and Recognized Component Mark.

See General Information Preceding These Recognitions

1/3/2001 **Underwriters Laboratories Inc.** **Card 1 of 2**

SUMITOMO CHEMICAL CO LTD **E54705 (M)**
5-33 KITAHAMA 4-CHOME CHUO-KO, OSAKA JAPAN

Mtl Dsg	Col	Min Thk mm	UL94 Flame Class	Elec	RTI		w/o Imp	H W I	H A I	H V R	D 4 T 5	C T I
					with Imp	Mech						
Liquid crystal polyester (LCP), designated "EKONOL" or "SUMIKASUPER", furnished in the form of pellets, (Contd)												
E4008, E400X	NC, BK	0.30	94V-0	130	130	130	—	—	—	—	—	—
		0.75	94V-0	130	130	130	3	4	—	—	—	—
		1.5	94V-0	130	130	130	2	4	—	—	—	—
E4008	NC, WT, BK	3.0	94V-0	130	130	130	1	4	0	5	4	—
		0.30	94V-0	130	130	130	—	—	—	—	—	—
		0.75	94V-0	220	180	220	3	4	—	—	—	—
E4010	NC, BK	1.5	94V-0	220	200	240	2	4	—	—	—	—
		3.0	94V-0	220	200	240	1	4	0	5	4	—
		0.30	94V-0	130	130	130	—	—	—	—	—	—
E400(Y)L, E4008L	NC, BK	0.75	94V-0	220	180	220	3	4	—	—	—	—
		1.5	94V-0	220	200	240	2	4	—	—	—	—
		3.0	94V-0	220	200	240	1	4	0	5	4	—
E4810	NC, BK	0.30	94V-0	130	130	130	—	—	—	—	—	—
		0.75	94V-0	130	130	130	3	4	—	—	—	—
		1.5	94V-0	130	130	130	2	4	—	—	—	—
		3.0	94V-0	130	130	130	1	4	0	5	4	—
		0.30	94V-0	130	130	130	—	—	—	—	—	—
		0.75	94V-0	130	130	130	0	4	—	—	—	—
		1.5	94V-0	130	130	130	0	4	—	—	—	—
		3.0	94V-0	130	130	130	1	4	0	5	4	—
		0.30	94V-0	130	130	130	—	—	—	—	—	—

(X) Denotes any number 1 thru 9.
(Y) Denotes any number 1 thru 7.



RoHS Compliant

NOTE : Specifications subject to change without notice. Please check our website for latest information.

18.04.2008



SUPERWORLD ELECTRONICS (S) PTE LTD