

### 1. PART NO. EXPRESSION :

<u>S</u>	<u>D</u>	<u>C</u>	<u>1</u>	<u>2</u>	<u>0</u>	<u>7</u>	-	<u>1</u>	<u>R</u>	<u>2</u>	<u>Y</u>	<u>F</u>
(a)	(b)	(c)	(d)(e)						(a) Series code	(d) Tolerance code : M = ±20%, Y = ±30%		
									(b) Dimension code	(e) F : Lead Free		
									(c) Inductance code : 1R2 = 1.2uH			

### 2. CONFIGURATION & DIMENSIONS :

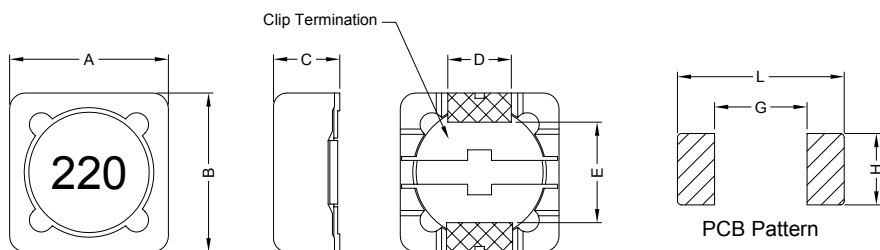

Unit:m/m

A	B	C	D	E	G	H	L
12.0±0.3	12.0±0.3	8.0 Max.	5.0±0.2	7.6±0.2	7.0 Ref.	5.4 Ref.	12.6 Ref.

### 3. SCHEMATIC :

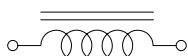

### 4. GENERAL SPECIFICATION :

- a) Temp. rise : 40°C Max.
- b) Ambient temp. : 25°C
- c) Rated current : Base on temp. rise &  $\Delta L/L0A = 30\%$  Max.
- d) Operating temp. : -25°C to +85°C
- e) Storage temp. : -25°C to +85°C



**RoHS Compliant**

NOTE : Specifications subject to change without notice. Please check our website for latest information.

12.05.2008



**SUPERWORLD ELECTRONICS (S) PTE LTD**

## 5. ELECTRICAL CHARACTERISTICS :

Part No.	Inductance ( $\mu$ H)	Test Frequency (Hz)	DCR ( $\Omega$ ) Max.	IDC (A) Max.
SDC1207-1R2YF	1.2 $\pm$ 30%	1V / 100K	0.0070	9.80
SDC1207-2R4YF	2.4 $\pm$ 30%	1V / 100K	0.0115	8.00
SDC1207-3R5YF	3.5 $\pm$ 30%	1V / 100K	0.0135	7.50
SDC1207-4R7YF	4.7 $\pm$ 30%	1V / 100K	0.0158	6.80
SDC1207-6R1YF	6.1 $\pm$ 30%	1V / 100K	0.0176	6.60
SDC1207-7R6YF	7.6 $\pm$ 30%	1V / 100K	0.0200	5.90
SDC1207-100MF	10 $\pm$ 20%	1V / 1K	0.0216	5.40
SDC1207-120MF	12 $\pm$ 20%	1V / 1K	0.0243	4.90
SDC1207-150MF	15 $\pm$ 20%	1V / 1K	0.0270	4.50
SDC1207-180MF	18 $\pm$ 20%	1V / 1K	0.0392	3.90
SDC1207-220MF	22 $\pm$ 20%	1V / 1K	0.0432	3.60
SDC1207-270MF	27 $\pm$ 20%	1V / 1K	0.0459	3.40
SDC1207-330MF	33 $\pm$ 20%	1V / 1K	0.0648	3.00
SDC1207-390MF	39 $\pm$ 20%	1V / 1K	0.0729	2.75
SDC1207-470MF	47 $\pm$ 20%	1V / 1K	0.100	2.50
SDC1207-560MF	56 $\pm$ 20%	1V / 1K	0.110	2.35
SDC1207-680MF	68 $\pm$ 20%	1V / 1K	0.140	2.10
SDC1207-820MF	82 $\pm$ 20%	1V / 1K	0.160	1.95
SDC1207-101MF	100 $\pm$ 20%	1V / 1K	0.220	1.70
SDC1207-121MF	120 $\pm$ 20%	1V / 1K	0.250	1.60
SDC1207-151MF	150 $\pm$ 20%	1V / 1K	0.280	1.42
SDC1207-181MF	180 $\pm$ 20%	1V / 1K	0.350	1.30
SDC1207-221MF	220 $\pm$ 20%	1V / 1K	0.390	1.16
SDC1207-271MF	270 $\pm$ 20%	1V / 1K	0.560	1.06
SDC1207-331MF	330 $\pm$ 20%	1V / 1K	0.640	0.95
SDC1207-391MF	390 $\pm$ 20%	1V / 1K	0.700	0.88
SDC1207-471MF	470 $\pm$ 20%	1V / 1K	0.980	0.79
SDC1207-561MF	560 $\pm$ 20%	1V / 1K	1.070	0.73
SDC1207-681MF	680 $\pm$ 20%	1V / 1K	1.460	0.67
SDC1207-821MF	820 $\pm$ 20%	1V / 1K	1.640	0.60
SDC1207-102MF	1000 $\pm$ 20%	1V / 1K	1.820	0.55



RoHS Compliant

NOTE : Specifications subject to change without notice. Please check our website for latest information.

12.05.2008



SUPERWORLD ELECTRONICS (S) PTE LTD

## 6. RELIABILITY AND TEST CONDITIONS :

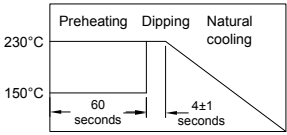
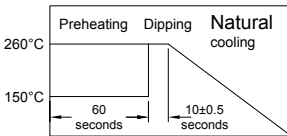
ITEM	PERFORMANCE	TEST CONDITION														
Electrical Characteristics Test																
Inductance	Refer to standard electrical characteristics list	HP4284A, CH11025, CH3302, CH1320, CH1320S LCR meter.														
DCR		CH16502, Agilent33420A Micro-Ohm Meter.														
Heat Rated Current (Irms)		Irms(A) will cause the coil temperature rise approximately $\Delta T=40^{\circ}\text{C}$ without core loss 1. Applied the allowed DC current 2. Temperature measured by digital surface thermometer														
Saturation Current (Isat)		Isat(A) will cause $L_0$ to drop approximately 20% max.														
Mechanical Performance Test																
Solderability Test	More than 90% of the terminal electrode should be covered with solder.  	Preheat : $150^{\circ}\text{C}$ , 60sec. Solder : Sn-Ag3.0-Cu0.5 Solder Temperature : $230\pm 5^{\circ}\text{C}$ Flux for lead free : rosin Dip Time : $4\pm 1$ sec.														
Solder Heat Resistance	1. Appearance : No significant abnormality 2. Inductance change : Within $\pm 20\%$  	Preheat : $150^{\circ}\text{C}$ , 60sec. Solder : Sn-Ag3.0-Cu0.5 Solder Temperature : $260\pm 5^{\circ}\text{C}$ Flux for lead free : rosin Dip Time : $10\pm 0.5$ sec.														
Reliability Test																
High Temperature Life Test	1. Appearance : No damage 2. Inductance : Within $\pm 20\%$ of initial value. No disconnection or short circuit.	Temperature : $85\pm 5^{\circ}\text{C}$ Time : $500\pm 12$ hours Measure at room temperature after placing for 2 to 3 hrs.														
Low Temperature Life Test		Temperature : $-25\pm 5^{\circ}\text{C}$ Time : $500\pm 12$ hours Measure at room temperature after placing for 2 to 3 hrs.														
Thermal Shock		Conditions of 1 cycle. <table border="1" data-bbox="933 1391 1299 1525"> <thead> <tr> <th>Step</th> <th>Temperature (<math>^{\circ}\text{C}</math>)</th> <th>Times (min.)</th> </tr> </thead> <tbody> <tr> <td>1</td> <td><math>-25\pm 3</math></td> <td><math>30\pm 3</math></td> </tr> <tr> <td>2</td> <td>Room Temperature</td> <td>Within 3</td> </tr> <tr> <td>3</td> <td><math>+85\pm 3</math></td> <td><math>30\pm 3</math></td> </tr> <tr> <td>4</td> <td>Room Temperature</td> <td>Within 3</td> </tr> </tbody> </table> Total : 5 cycles Measure at room temperature after placing for 2 to 3 hrs.	Step	Temperature ( $^{\circ}\text{C}$ )	Times (min.)	1	$-25\pm 3$	$30\pm 3$	2	Room Temperature	Within 3	3	$+85\pm 3$	$30\pm 3$	4	Room Temperature
Step	Temperature ( $^{\circ}\text{C}$ )	Times (min.)														
1	$-25\pm 3$	$30\pm 3$														
2	Room Temperature	Within 3														
3	$+85\pm 3$	$30\pm 3$														
4	Room Temperature	Within 3														
Humidity Resistance	1. Appearance : No damage 2. Inductance : Within $\pm 20\%$ of initial value. No disconnection or short circuit.	Temperature : $40\pm 5^{\circ}\text{C}$ Humidity : 90% to 95% Applied Current : Rated Current Time : $500\pm 12$ hours Measure at room temperature after placing for 2 to 3 hrs.														



**RoHS Compliant**

NOTE : Specifications subject to change without notice. Please check our website for latest information.

12.05.2008



**SUPERWORLD ELECTRONICS (S) PTE LTD**

## 7. SOLDERING AND MOUNTING :

### 7-1. Recommended PC Board Pattern

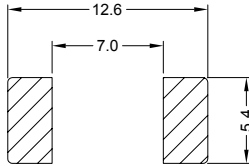

### 7-2. Soldering

Mildly activated rosin fluxes are preferred. The minimum amount of solder can lead to damage from the stresses caused by the difference in coefficients of expansion between solder, chip and substrate. Our terminations are suitable for all wave and re-flow soldering systems. If hand soldering cannot be avoided, the preferred technique is the utilization of hot air soldering tools.

#### 7-2.1 Solder Re-flow :

Recommended temperature profiles for re-flow soldering in Figure 1.

#### 7-2.2 Soldering Iron (Figure 2) :

Products attachment with soldering iron is discouraged due to the inherent process control limitations. In the event that a soldering iron must be employed the following precautions are recommended.

Note :

- Preheat circuit and products to 150°C.
- 280°C tip temperature (max)
- Never contact the ceramic with the iron tip
- 1.0mm tip diameter (max)
- Use a 20 watt soldering iron with tip diameter of 1.0mm
- Limit soldering time to 3 secs.

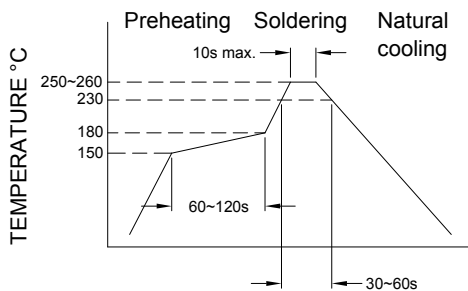

Figure 1. Re-flow Soldering

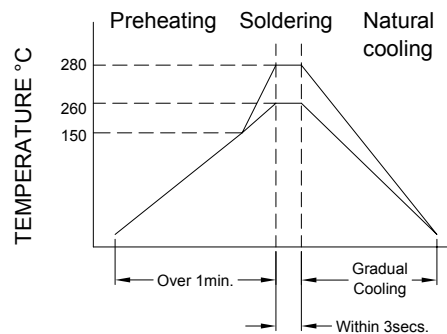

Figure 2. Iron Soldering



**RoHS Compliant**

NOTE : Specifications subject to change without notice. Please check our website for latest information.

12.05.2008



**SUPERWORLD ELECTRONICS (S) PTE LTD**

## 8. PACKAGING INFORMATION :

### 8-1. Tape and Reel Dimension

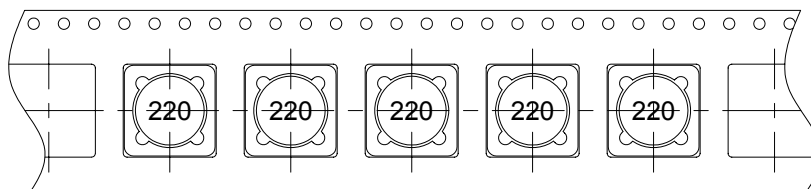
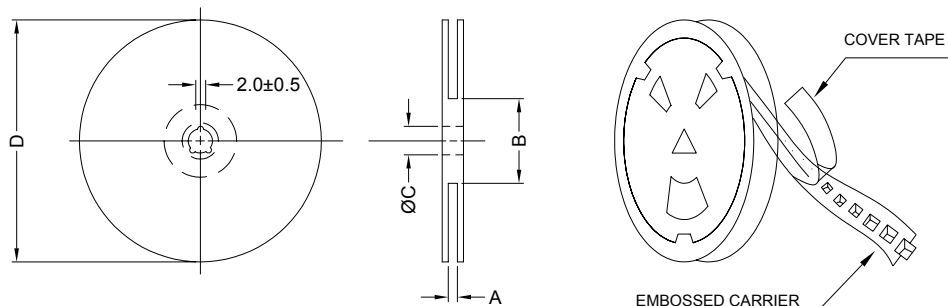

Type	A(mm)	B(mm)	C(mm)	D(mm)
13" x 24mm	24.0±0.1	100±1	13±0.5	330

### 8-3. Packaging Quantity

Size	SDC1207
Chip / Reel	200
Reel Style	13" x 24mm



**RoHS Compliant**

NOTE : Specifications subject to change without notice. Please check our website for latest information.

12.05.2008



**SUPERWORLD ELECTRONICS (S) PTE LTD**