

Distinctive Characteristics

Industry's first LED illumination at tip of toggle and paddle switches.

Single color LEDs of red, yellow, and green, plus bicolor red/green, to meet varied design requirements.

LEDs can operate independently from or synchronously with switching operation.

Antijamming feature to protect contacts from damage due to excessive downward force on the toggle.

High torque bushing prevents the bushing from rotating or separating from the metal frame during installation.

Stainless steel frame resists corrosion.

Silver contacts are of specially composed alloy for hardness.

High insulating barriers protect against crossover in double pole devices.

Terminals are molded in and epoxy sealed to lock out flux, dust, and other contaminants.

1,500V dielectric strength between switch contacts and case is accomplished by clinching the frame away from the terminals.

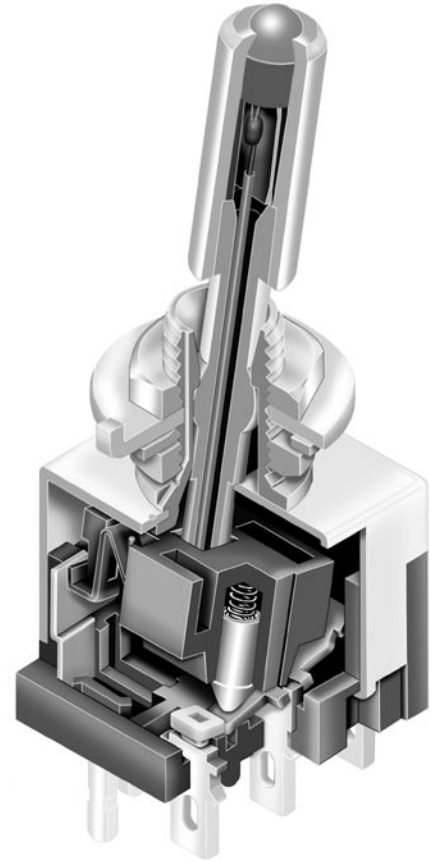

Actual Size

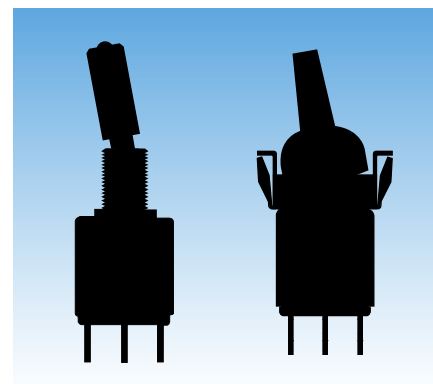

General Specifications

Electrical Capacity (Resistive Load)

Power Level (code W): 6A @ 125V AC or 3A @ 250V AC or 3A @ 30V DC
Logic Level (code G): 0.4VA maximum @ 28V AC/DC maximum
 (Applicable Range 0.1mA ~ 0.1A @ 20mV ~ 28V)
 Note: Find additional explanation of operating range in Supplement section.

Other Ratings

Contact Resistance: 10 milliohms maximum for silver; 20 milliohms maximum for gold
Insulation Resistance: 1,000 megohms minimum @ 500V DC
Dielectric Strength: 1,000V AC minimum between contacts for 1 minute minimum;
 1,500V AC minimum between contacts & case for 1 minute minimum
Mechanical Life: 50,000 operations minimum
Electrical Life: 25,000 operations minimum
Nominal Operating Force:

		On-to-On Position	Off-to-On Position
Toggles & Paddles	Single Pole	3.19N	3.92N
	Double Pole	4.41N	7.06N
Rockers	Single Pole	6.37N	9.80N
	Double Pole	13.73N	17.65N

Angle of Throw: 20°

Materials & Finishes

Bushing: Brass with nickel plating
Housing: Stainless steel
Mounting Bracket: Steel with tin plating
Movable Contacts: Silver alloy or silver alloy with gold plating
Stationary Contacts: Silver with silver plating or copper or brass with gold plating
Lamp Contacts: Phosphor bronze
Base: Diallyl phthalate (UL94V-0)
Switch Terminals: Copper with silver or gold plating
Lamp Terminals: Brass with silver or gold plating



Environmental Data

Operating Temp Range: -10°C through +55°C (+14°F through +131°F) for toggles & rockers
 -25°C through +70°C (-13°F through +158°F) for paddles
Humidity: 90 ~ 95% humidity for 96 hours @ 40°C (104°F)
Vibration: 10 ~ 55Hz with peak-to-peak amplitude of 1.5mm traversing the frequency range
 & returning in 1 minute; 3 right angled directions for 2 hours
Shock: 50G (490m/s²) acceleration (tested in 6 right angled directions, with 5 shocks in each direction)

Installation

Mounting Torque: 1.47Nm (13 lb•in) for double nut; .67Nm (6 lb•in) for single nut
Soldering Time & Temp: Wave Soldering (PC version): See Profile B in Supplement section.
 Manual Soldering: See Profile B in Supplement section.
 Note: Lever must be in center position while soldering.
Cleaning: PC mountable device is not process sealed. Hand clean locally using alcohol based solution.

Standards & Certifications

Flammability Standards: UL94V-0 base
 **UL Recognized:** Single pole toggles & rockers with synchronous circuits & solder lug or PC recognized at 6A @ 125V AC; UL File No. WOYR2.E44145; add "/U" to end of part number to order UL mark on switch.
 **CSA Certified:** All single pole toggles & rockers with synchronous circuits certified at 6A @ 125V AC; CSA File No. 023535-0-000; add "/C" to end of part number to order CSA mark on switch.

TYPICAL SWITCH ORDERING EXAMPLE

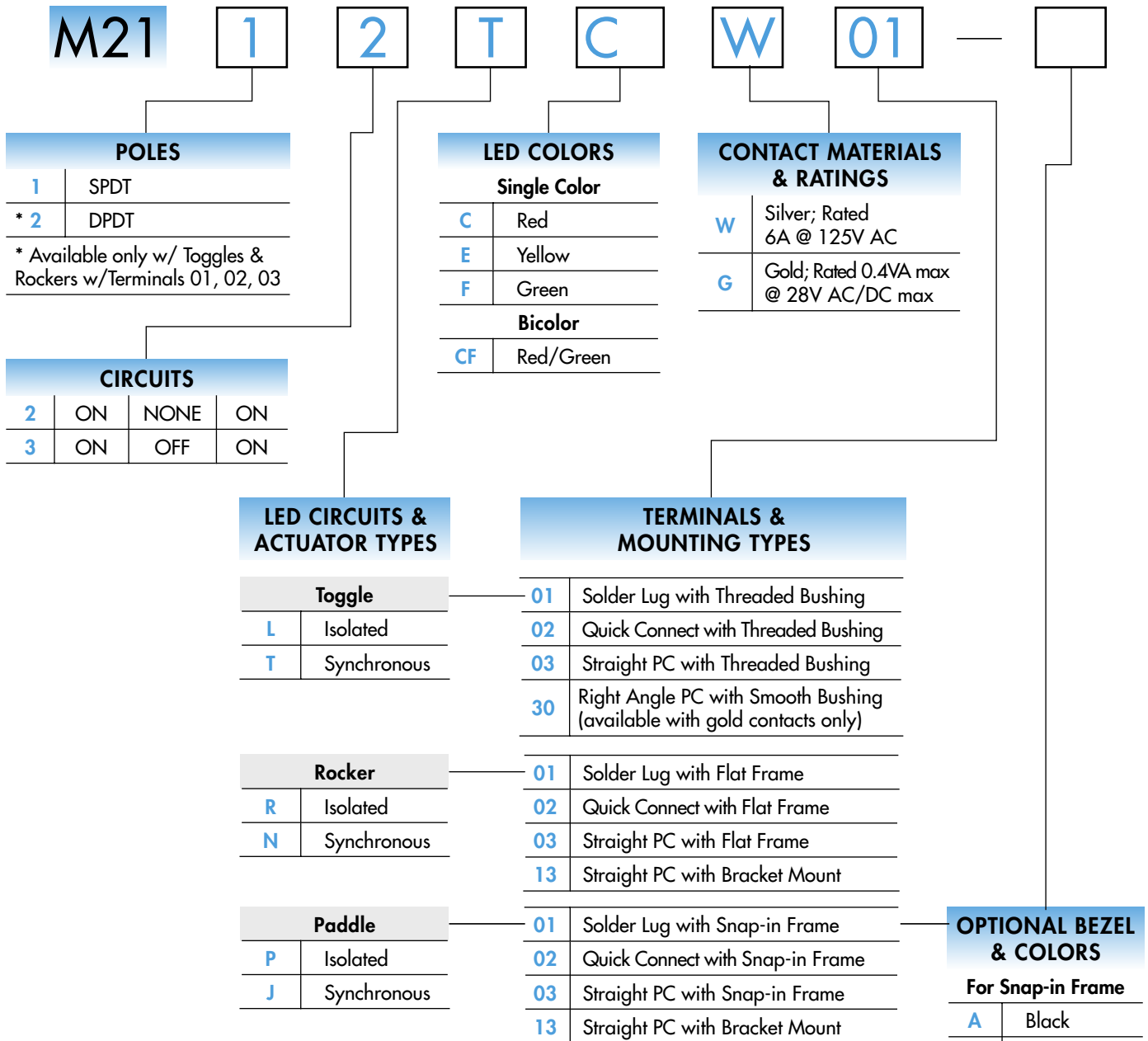

DESCRIPTION FOR TYPICAL ORDERING EXAMPLE

M2112TCW01



- Red LED
- Synchronous LED Circuit in Toggle Actuator
- SPDT ON-NONE-ON Switch Circuit
- Silver Contacts with 6-amp Rating
- Solder Lug Terminals

IMPORTANT:



Switches are supplied without UL & CSA marking unless specified. Specific models & ratings noted on General Specifications page.

POLES & CIRCUITS & LED ILLUMINATION

Model		Pole & Throw	Toggle Position & Terminal Numbers			Schematics
			Down <small>Keyway</small>	Center	Up	
M2112 SPDT			ON	NONE	ON	Notes: Terminal numbers are not actually on the switch. LEDs require an external power source.
Connected Power Terminals			2-3	NONE	2-1	
LED Circuit	Isolated LEDs (see schematics) Connected LED Terminals	ON	NONE	ON	Isolated Single Color LED	
	Synchronous Single Color LED Connected LED Terminals	ON	NONE	OFF	Isolated Bicolor LED	
	Synchronous Bicolor LED Connected LED Terminals	Red	NONE	Green		
M2113 SPDT			ON	OFF	ON	Synchronous Single Color LED Synchronous Bicolor LED
Connected Power Terminals			2-3	OPEN	2-1	
LED Circuit	Isolated LEDs (see schematics) Connected LED Terminals	ON	ON	ON		
	Synchronous Single Color LED Connected LED Terminals	ON	OFF	ON		
	Synchronous Bicolor LED Connected LED Terminals	Red	OFF	Green		
M2122 DPDT			ON	NONE	ON	Isolated Single Color LED Isolated Bicolor LED
Connected Power Terminals			2-3 5-6	NONE	2-1 5-4	
LED Circuit	Isolated LEDs (see schematics) Connected LED Terminals	ON	NONE	ON		
	Synchronous Single Color LED Connected LED Terminals	ON	NONE	OFF		
	Synchronous Bicolor LED Connected LED Terminals	Red	NONE	Green		
M2123 DPDT			ON	OFF	ON	Synchronous Single Color LED Synchronous Bicolor LED
Connected Power Terminals			2-3 5-6	OPEN	2-1 5-4	
LED Circuit	Isolated LEDs (see schematics) Connected LED Terminals	ON	ON	ON		
	Synchronous Single Color LED Connected LED Terminals	ON	OFF	ON		
	Synchronous Bicolor LED Connected LED Terminals	Red	OFF	Green		

LED COLORS & SPECIFICATIONS

Single Element LED		Toggles & Rockers			Toggles	Rockers	Paddles				Units
		Single Color			Bicolor	Bicolor	Single Color			Bicolor	
		C	E	F	CF	CF	C	E	F	CF	
Color		Red	Yellow	Green	Red/Green	Red/Green	Red	Yellow	Green	Red/Green	
LED factory assembled											
Not available separately											
Bicolor is white in OFF state.											
Forward Peak Current	I_{FM}	25	30	30	25	25	10	30	30	30/25	mA
Continuous Forward Current	I_F	20	20	20	10	20	8	24	24	20/20	mA
Forward Voltage	V_F	2.1	2.1	2.1	1.9	2.1	1.9	2.0	2.1	2.0/2.2	V
Reverse Peak Voltage	V_{RM}	4	4	4	—	—	5	5	5	—	V
Current Reduction Rate Above 25°C	ΔI_F	0.33	0.40	0.40	0.33/0.33	0.33/0.33	0.13	0.40	0.40	0.43/0.38	mA/°C
Ambient Temperature Range		-10° ~ +55°C					-25° ~ +70°C				

LED CIRCUIT, TOGGLE, & MOUNTING TYPE COMBINATIONS



Toggle with Isolated LED Circuit



Toggle with Synchronous LED Circuit

Finish: Brushed aluminum

Standard Hardware: 2 AT513H Hex Nuts, 1 AT507H Locking Ring, 1 AT509 Lockwasher Standard & optional hardware details in Accessories & Hardware section.

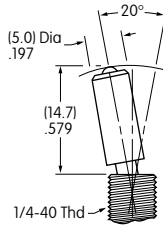

Threaded Bushing combines with Terminal codes 01, 02, & 03.

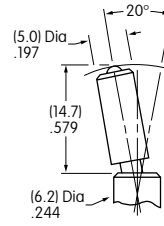

Smooth Bushing combines with Terminal code 30.

Max. Panel Thickness with Standard Hardware .102" (2.6mm)

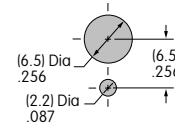

Max. Panel Thickness without Locking Ring .134" (3.4mm)

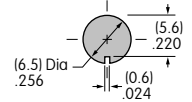

TYPICAL TOGGLE SWITCH DIMENSIONS

Solder Lug



M2112TCFW01

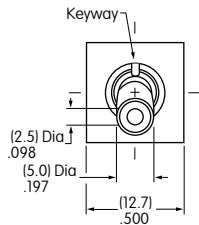

Single Pole

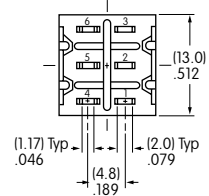
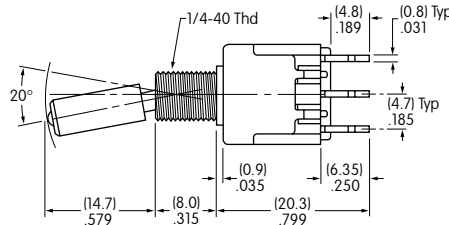

Single color LED switch does not have terminal 5.

Solder Lug



M2122TCFW01

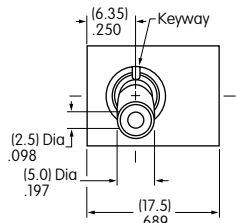

Double Pole

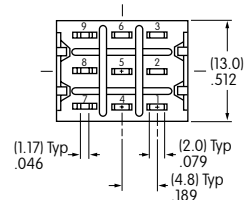
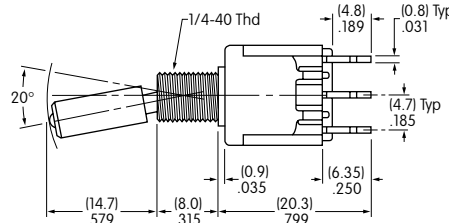

Single color LED switch does not have terminal 8.

Right Angle PC



M2112TCFG30

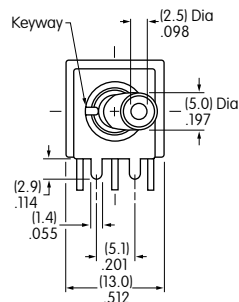

Single Pole Only

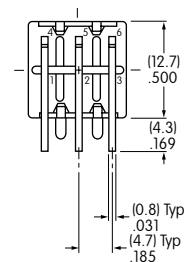
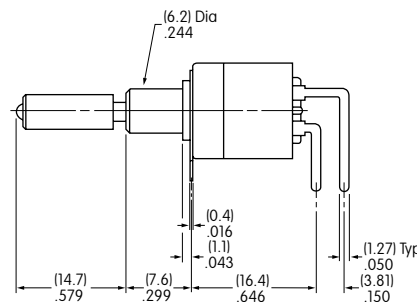

Single color LED switch does not have terminal 5.

Gold contact material only

LED CIRCUIT, ROCKER, & MOUNTING TYPE COMBINATIONS

- R** Rocker with Isolated LED Circuit
- N** Rocker with Synchronous LED Circuit

Material: Polyamide
 Finish: Matte
 Color: Black

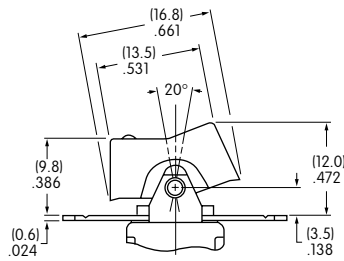

Flat Frame combines with Terminal codes 01, 02, & 03.

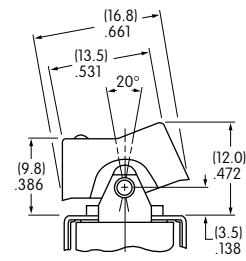

Bracket combines with Terminal code 13.

Max. Panel Thickness
 .126" (3.2mm)

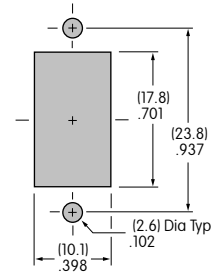

TYPICAL ROCKER SWITCH DIMENSIONS

Solder Lug

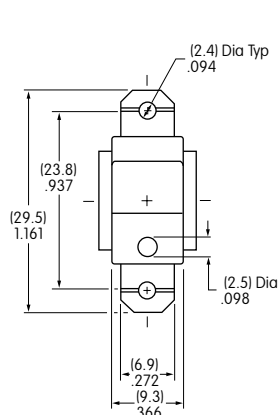

Single Pole

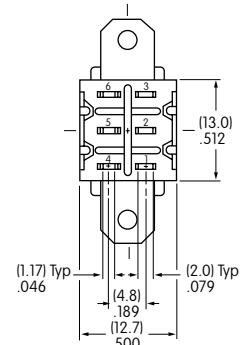
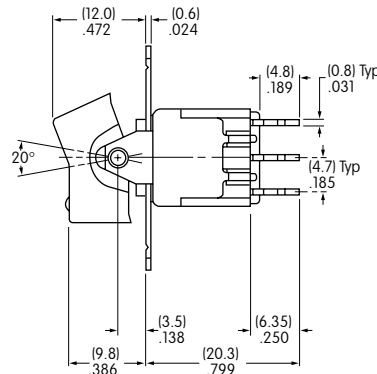

Single color LED switch does not have terminal 5.

M2112NCFW01

Solder Lug

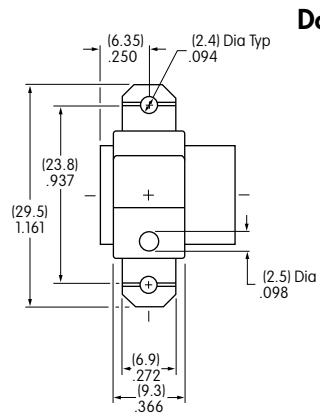

Double Pole

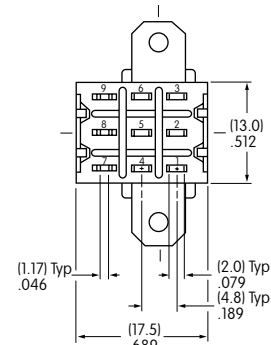
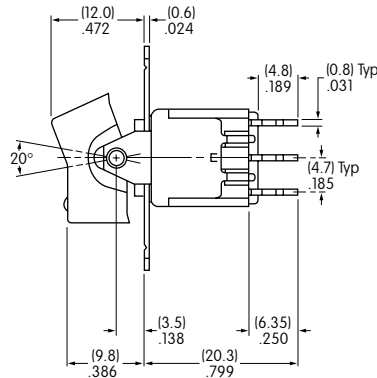

Single color LED switch does not have terminal 8.

M2122NCFW01

Straight PC • Bracket

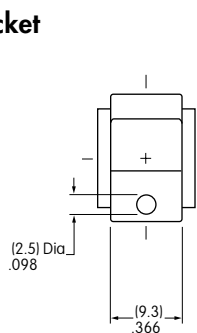

Single Pole Only

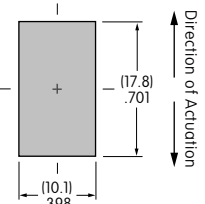
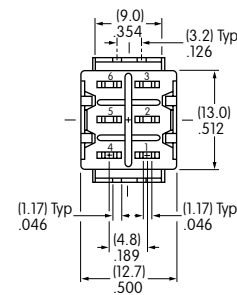
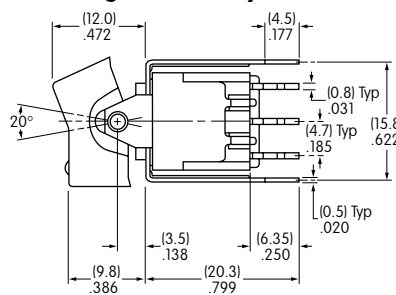

Single color LED switch does not have terminal 5. Silver contact material is standard.

M2112NCFW13

LED CIRCUIT, PADDLE, & MOUNTING TYPE COMBINATIONS

P Paddle with Isolated LED Circuit

J Paddle with Synchronous LED Circuit

Material: Polyamide
Finish: Matte
Color: Black

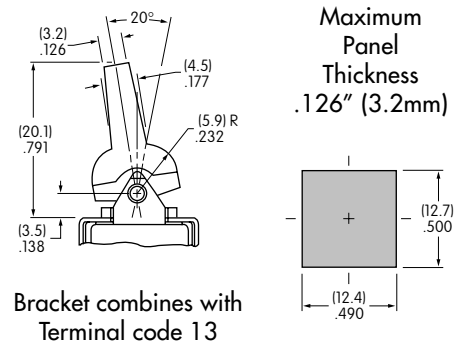
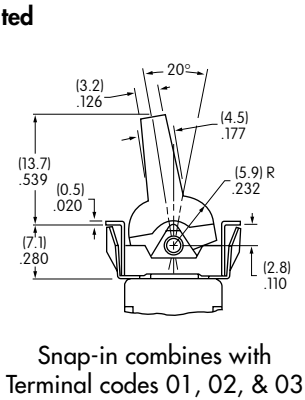

TYPICAL PADDLE SWITCH DIMENSIONS

Solder Lug • Snap-in



M2112JCFW01

Single Pole Only

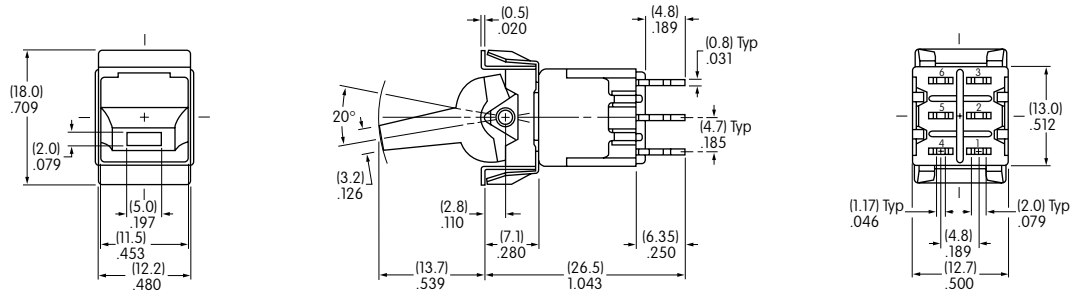

Straight PC • Bracket



M2112JCFW13

Single Pole Only

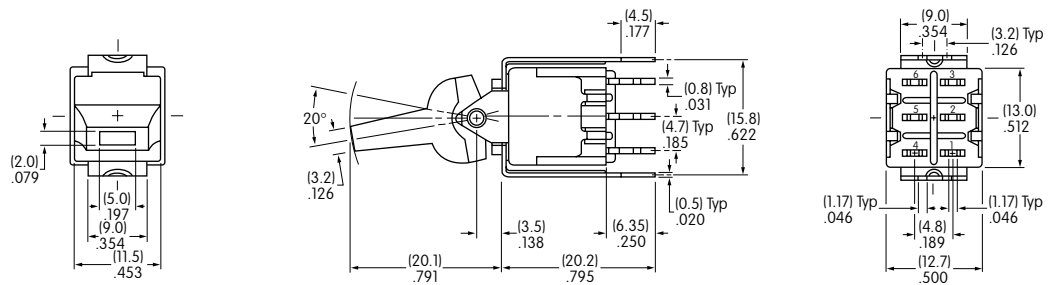

OPTIONAL BEZEL & COLORS

AT2107 Bezel for Snap-in Panel Frame

Material: Polyamide

Finish: Matte

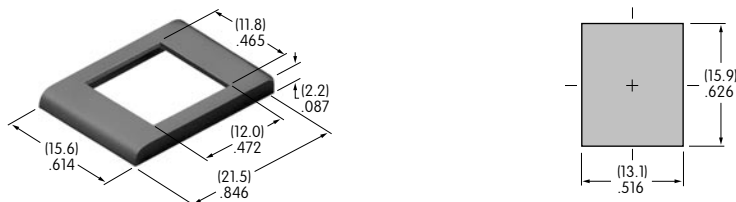

Colors Available: **A** Black **B** White **C** Red **E** Yellow **F** Green **G** Blue **H** Gray

CONTACT MATERIALS & RATINGS

W Silver over Silver Power Level 6A @ 125V AC & 3A @ 250V AC

G Gold over Brass or Copper Logic Level 0.4VA maximum @ 28V AC/DC maximum
 Complete explanation of operating range in Supplement section.

TERMINALS

01 Solder Lug with Turret LED Terminal

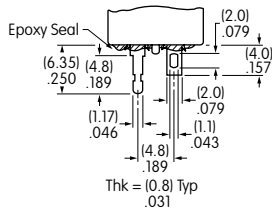

02 Quick Connect

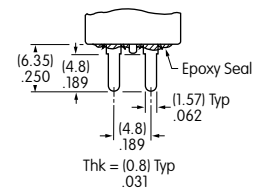

03 Straight PC with Turret LED Terminal

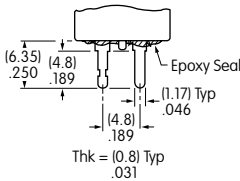

Single Pole

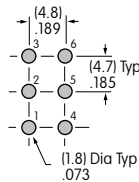

Single color LED switch does not have terminal 5.

Double Pole

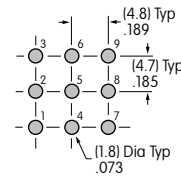

Single color LED switch does not have terminal 8.

13 Straight PC with Bracket & Turret LED Terminal

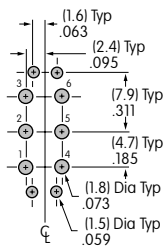
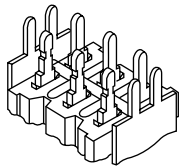

Single color LED switch does not have terminal 5.

30 Right Angle PC

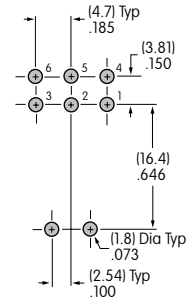
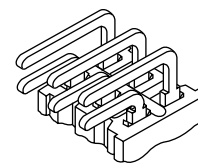

STANDARD MOUNTING HARDWARE

AT513H
 Hexagon Nuts (2 per switch)
Material: Brass with nickel plating

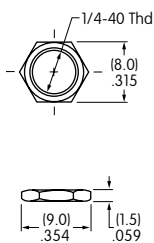

AT507H
 Locking Ring (1 per switch)
Material: Steel with chromate over zinc

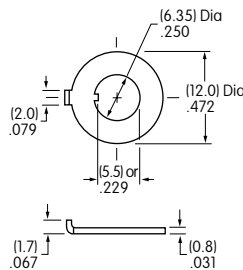

AT509
 Lockwasher (1 per switch)
Material: Steel with chromate over zinc

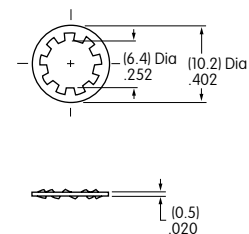

Optional Hardware: Knurled nuts, dress nuts, and ON-OFF plates are available; see details in Accessories & Hardware section.