

High Current, High Frequency, Power Inductors

HCP0704 Series

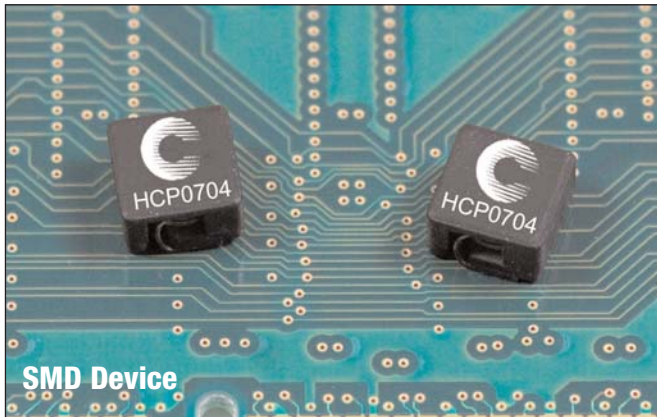

Description:

- Halogen free
- 155°C maximum total temperature operation
- 6.8 x 6.8 x 4.2mm surface mount package
- Powder iron core material
- Magnetically shielded, low EMI
- High temperature core material eliminates thermal aging issues
- High current carrying capacity, low core losses
- Controlled DCR tolerance for sensing circuits
- Inductance range from 0.40μH to 4.7μH
- Current range from 5.0 to 27 amps
- Frequency range up to 2MHz
- RoHS compliant

Applications:

- Voltage Regulator Module (VRM)
- Multi-phase regulators
- Desktop and servers
- Base station equipment
- Notebook regulators
- Data networking and storage systems
- Point-of-load modules
- Battery power systems
- DCR sensing



Environmental Data:

- Storage temperature range: -40°C to +155°C
- Operating temperature range: -40°C to +155°C (Range is application specific)
- Solder reflow temperature: J-STD-020D compliant

Packaging:

- Supplied in tape-and-reel packaging, 1000 parts per reel, 13" diameter reel

Product Specifications

Part Number ⁶	OCL ¹ ± 25% (μH)	FLL ² Min. (μH)	I _{rms} ³ (Amps)	I _{sat} ⁴ @ 25°C (Amps)	DCR (mΩ) @ 20°C	K-factor ⁵
HCP0704-R40-R	0.40	0.28	17	27	3.2 ±10%	383.1
HCP0704-R60-R	0.60	0.42	14	21	4.5 ±10%	313.5
HCP0704-1R0-R	1.00	0.7	12	17	6.2 ±10%	265.3
HCP0704-1R8-R	1.80	1.26	8.5	13	11.0 ±10%	202.8
HCP0704-2R3-R	2.30	1.56	7.5	11.5	16.5 ±10%	164.2
HCP0704-3R3-R	3.30	2.31	6.0	9.5	25.0 ±10%	149.9
HCP0704-4R7-R	4.70	3.29	5.0	8.0	29.5 ±10%	127.7

1 Open Circuit Inductance (OCL) Test Parameters: 100kHz, 0.10V_{rms}, 0.0A_{dc}

2 Full Load Inductance (FLL) Test Parameters: 100kHz, 0.1V_{rms}, I_{sat}¹

3 I_{rms}: DC current for an approximate temperature rise of 40°C without core loss. Derating is necessary for AC currents. PCB pad layout, trace thickness and width, air-flow and proximity of other heat generating components will affect the temperature rise. It is recommended the part temperature not exceed 155°C under worst case operating conditions verified in the end application.

4 I_{sat}: Peak current for approximately 20% rolloff at +25°C.

5 K-factor: Used to determine B_{p-p} for core loss (see graph). B_{p-p} = K * L * ΔI : (Gauss), K: (K-factor from table), L: (inductance in μH), ΔI (peak-to-peak ripple current in amps).

6 Part Number Definition: HCP0704-xxx-R

- HCP0704 = Product code and size
- xxx= Inductance value in μH, R = decimal point. If no "R" is present, then third character = # of zeros
- "-R" suffix = RoHS compliant

Dimensions - mm

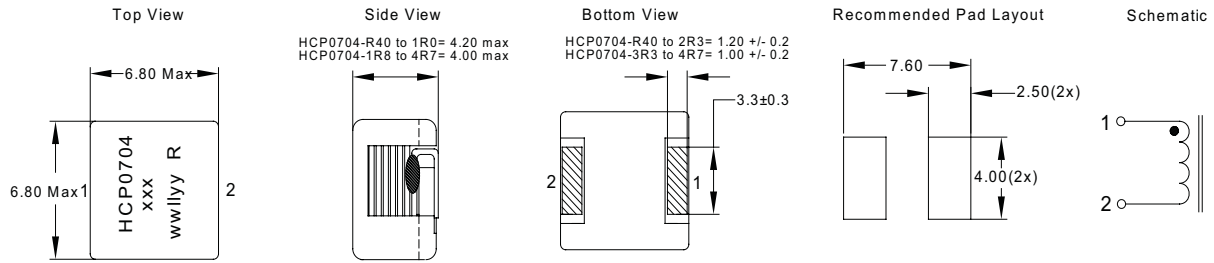

The nominal DCR test point is in the middle of the terminal

Part Marking: HCP0704 xxx = Inductance value in μH . (R = Decimal point). If no "R" is present, then last character is # of zeros wwllly = Date code R = Revision level

Packaging Information - mm

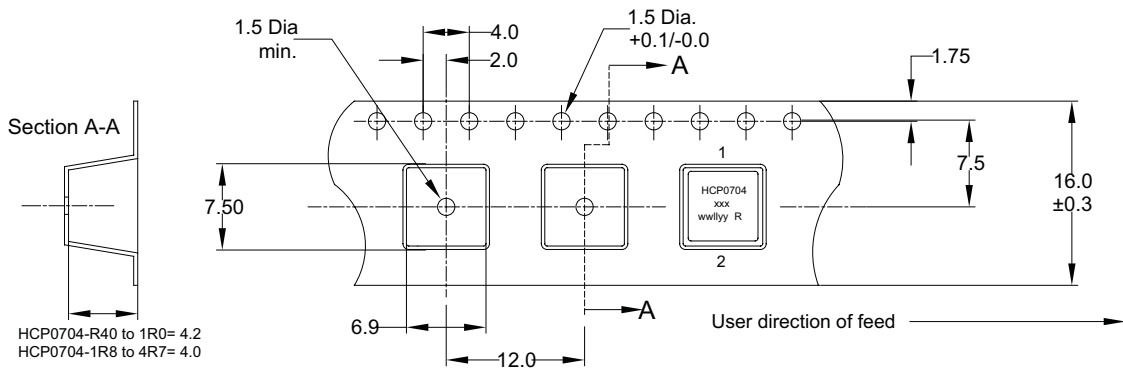

Supplied in tape-and-reel packaging, 1000 parts per reel, 13" diameter reel.

Temperature Rise vs. Total Loss

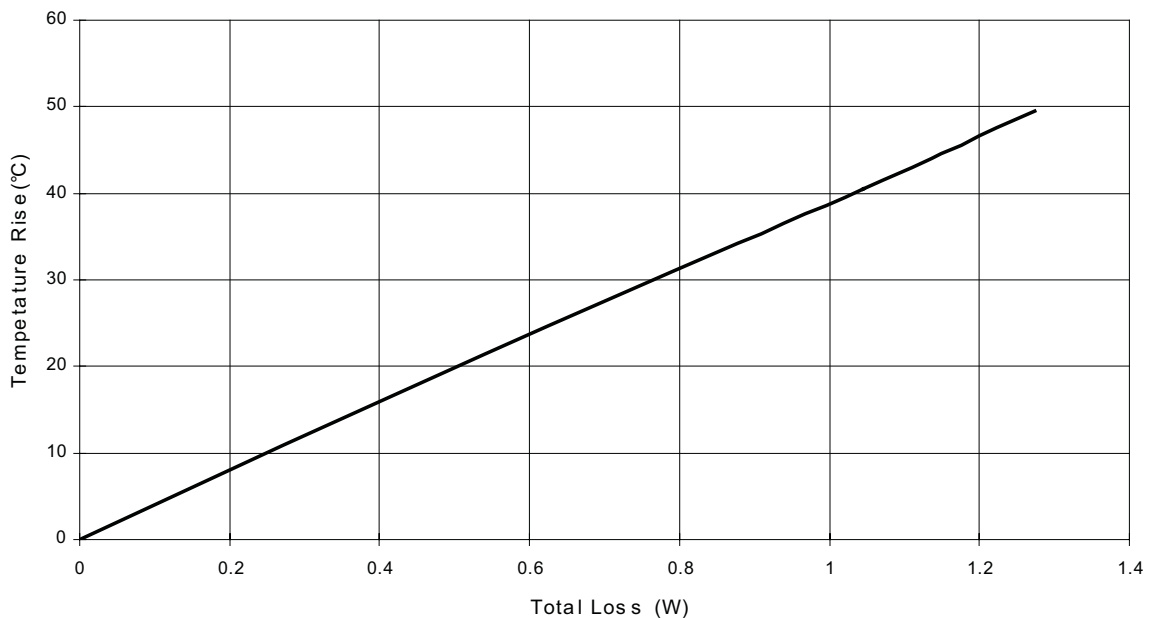

Core Loss

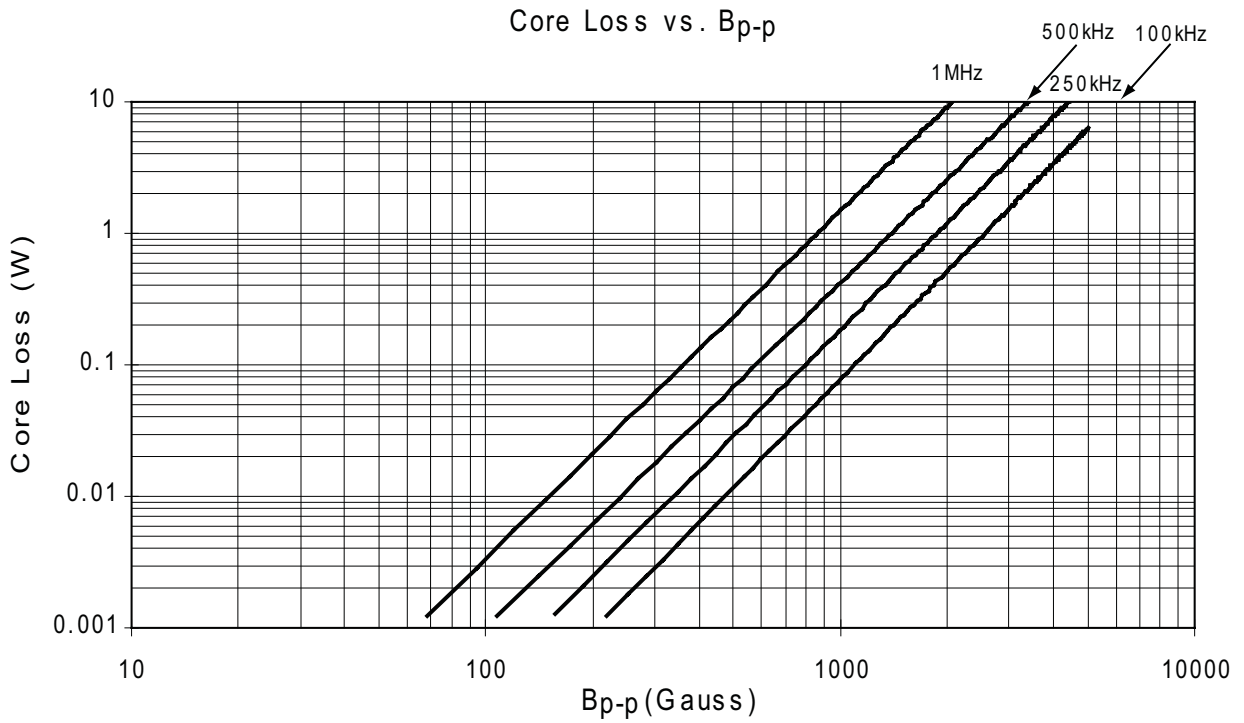

Inductance Characteristics

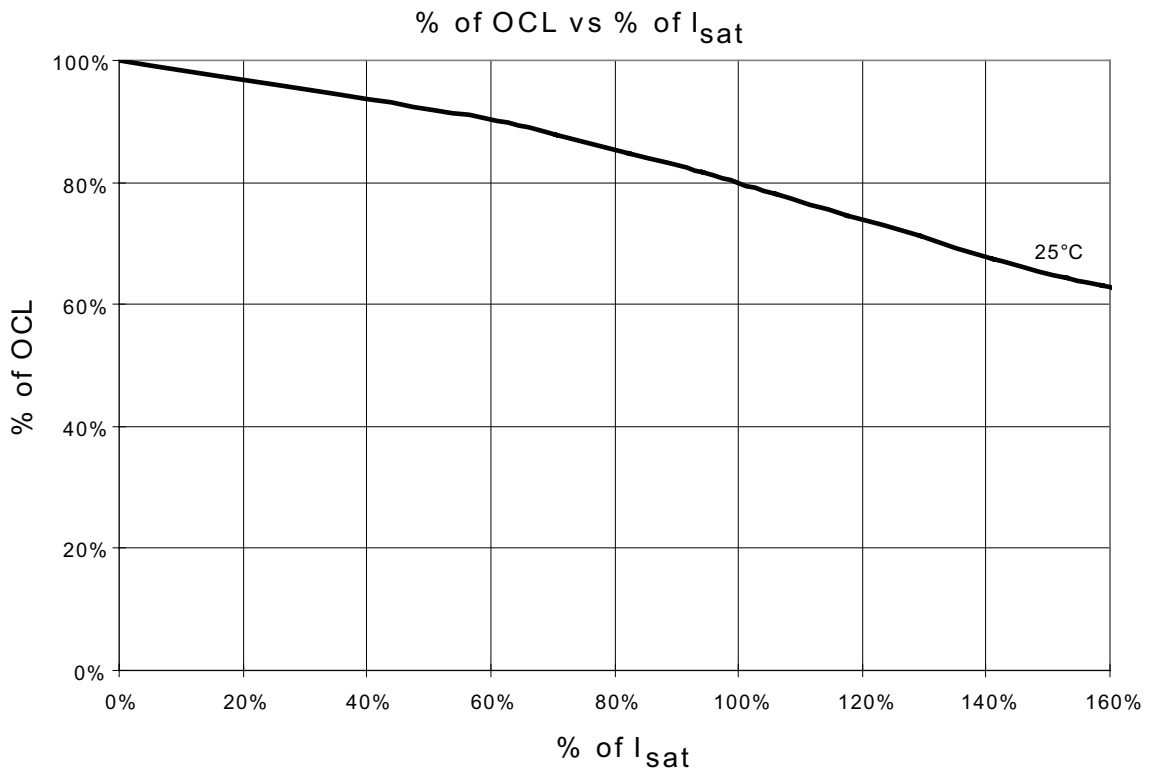

Solder Reflow Profile

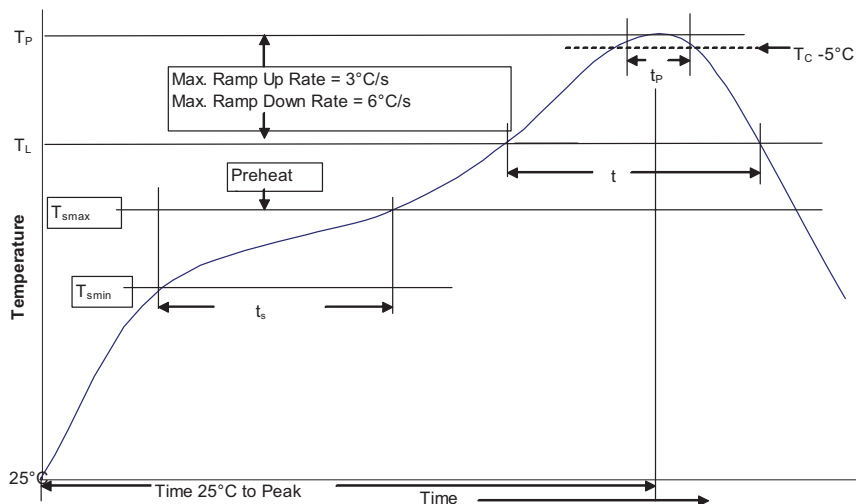

Table 1 - Standard SnPb Solder (T_c)

Package Thickness	Volume mm^3 <350	Volume mm^3 ≥ 350
<2.5mm	235°C	220°C
$\geq 2.5\text{mm}$	220°C	220°C

Table 2 - Lead (Pb) Free Solder (T_c)

Package Thickness	Volume mm^3 <350	Volume mm^3 350 - 2000	Volume mm^3 >2000
<1.6mm	260°C	260°C	260°C
1.6 - 2.5mm	260°C	250°C	245°C
>2.5mm	250°C	245°C	245°C

Reference JDEC J-STD-020D

Profile Feature	Standard SnPb Solder	Lead (Pb) Free Solder
Preheat and Soak		
• Temperature min. (T_{smin})	100°C	150°C
• Temperature max. (T_{smax})	150°C	200°C
• Time (T_{smin} to T_{smax}) (t_s)	60-120 Seconds	60-120 Seconds
Average ramp up rate T_{smax} to T_p	3°C/ Second Max.	3°C/ Second Max.
Liquidous temperature (T_L)	183°C	217°C
Time at liquidous (t_L)	60-150 Seconds	60-150 Seconds
Peak package body temperature (T_p)*	Table 1	Table 2
Time (t_p)** within 5 °C of the specified classification temperature (T_c)	20 Seconds**	30 Seconds**
Average ramp-down rate (T_p to T_{smax})	6°C/ Second Max.	6°C/ Second Max.
Time 25°C to Peak Temperature	6 Minutes Max.	8 Minutes Max.

* Tolerance for peak profile temperature (T_p) is defined as a supplier minimum and a user maximum.

** Tolerance for time at peak profile temperature (t_p) is defined as a supplier minimum and a user maximum.

North America

Cooper Electronic Technologies
1225 Broken Sound Parkway NW
Suite F
Boca Raton, FL 33487-3533
Tel: 1-561-998-4100
Fax: 1-561-241-6640
Toll Free: 1-888-414-2645

Cooper Bussmann
P.O. Box 14460
St. Louis, MO 63178-4460
Tel: 1-636-394-2877
Fax: 1-636-527-1607

Europe

Cooper Electronic Technologies
Cooper (UK) Limited
Burton-on-the-Wolds
Leicestershire • LE12 5TH UK
Tel: +44 (0) 1509 882 737
Fax: +44 (0) 1509 882 786

Cooper Electronic Technologies
Avda. Santa Eulalia, 290
08223
Terrassa, (Barcelona), Spain
Tel: +34 937 362 812
+34 937 362 813
Fax: +34 937 362 719

Asia Pacific

Cooper Electronic Technologies
1 Jalan Kilang Timor
#06-01 Pacific Tech Centre
Singapore 159303
Tel: +65 278 6151
Fax: +65 270 4160

The only controlled copy of this Data Sheet is the electronic read-only version located on the Cooper Bussmann Network Drive. All other copies of this document are by definition uncontrolled. This bulletin is intended to clearly present comprehensive product data and provide technical information that will help the end user with design applications. Cooper Bussmann reserves the right, without notice, to change design or construction of any products and to discontinue or limit distribution of any products. Cooper Bussmann also reserves the right to change or update, without notice, any technical information contained in this bulletin. Once a product has been selected, it should be tested by the user in all possible applications.

Life Support Policy: Cooper Bussmann does not authorize the use of any of its products for use in life support devices or systems without the express written approval of an officer of the Company. Life support systems are devices which support or sustain life, and whose failure to perform, when properly used in accordance with instructions for use provided in the labeling, can be reasonably expected to result in significant injury to the user.