

PHASE CONTROL THYRISTOR H507CHXX

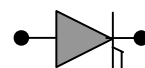

Symbol	Characteristics	Conditions	T_J ($^{\circ}\text{C}$)	Value	Unit
BLOCKING PARAMETERS					
V_{RRM}	Repetitive peak reverse voltage		125	200-1600	V
V_{DRM}	Repetitive peak off-stage voltage		125	200-1600	V
I_{RRM}	Repetitive peak reverse current	$V = V_{RRM}$	125	50	mA
I_{DRM}	Repetitive peak off-state current	$V = V_{RRM}$	125	50	mA
CONDUCTING PARAMETERS					
$I_{F(AV)}$	Average on-state current	180 sine, 50Hz, $T_C = 85^{\circ}\text{C}$		507	A
I_{RMS}	RMS on-state current			800	A
I_{TSM}	Surge on-state current	Sine wave, 10mS without reverse voltage	125	8	kA
I^2t	I^2t			320	kA^2S
V_T	Peak on-state voltage drop	On-state current = 1.6kA	125	1.92	V
V_0	Threshold voltage		125	0.80	V
R_0	On-state slope resistance		125	0.60	$\text{m}\Omega$
TRIGGERING PARAMETERS					
I_{GT}	Gate trigger current	$V_D = 5V$	25	200	mA
V_{GT}	Gate trigger voltage		25	2.00	V
I_L	Latching Current	$V_D = 5V$	25	600	mA
P_{G-PEAK}	Maximum Peak Gate Power	Pulse width 100 μSec		150	W
di/dt	Repetitive rate of rise of current			250	$\text{A}/\mu\text{Sec}$
V_{FGM}	Maximum forward gate voltage			12	V
I_{FGM}	Maximum forward gate current			30	A
THERMAL & MECHANICAL PARAMETERS					
$R_{TH(J-C)}$	Thermal impedance, 180 conduction, Sine	Junction to case		0.053	$^{\circ}\text{C}/\text{W}$
$R_{TH(C-HK)}$	Thermal impedance	Case to heatsink		0.015	$^{\circ}\text{C}/\text{W}$
T_J	Maximum Permissible junction temperature			125	$^{\circ}\text{C}$
T_{STG}	Storage temperature range			-40 - 125	$^{\circ}\text{C}$
F	Mounting Torque			8	KN
W	Weight			100	gms



PHASE CONTROL THYRISTOR H507CHXX

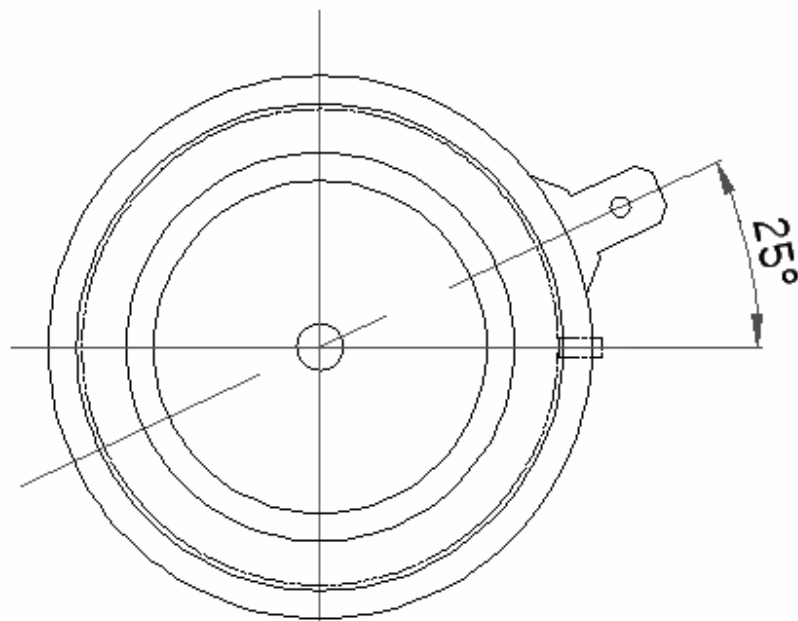
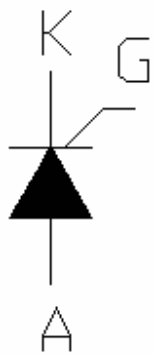
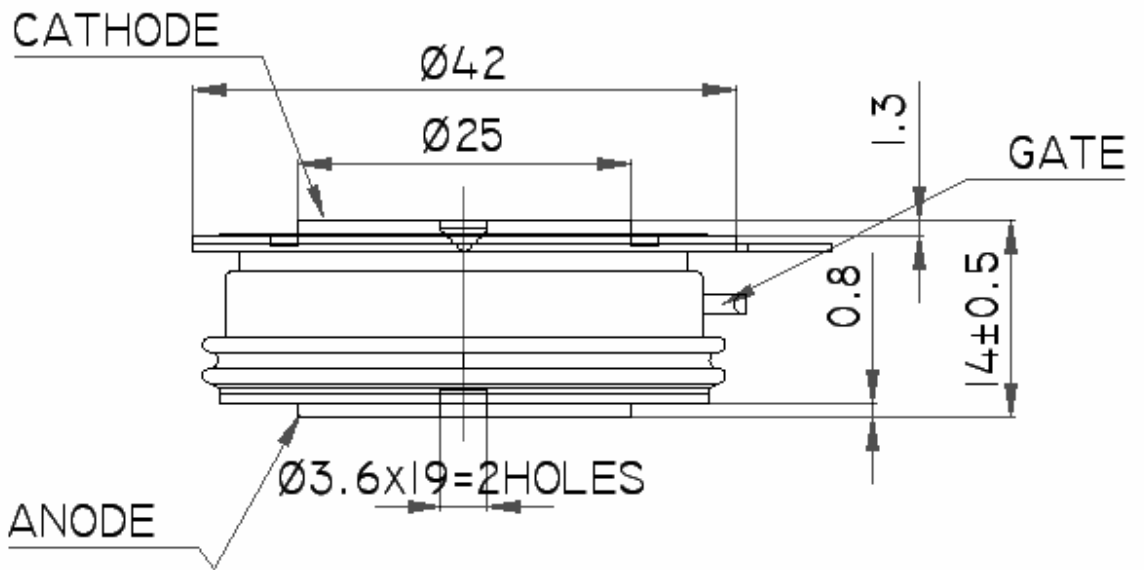
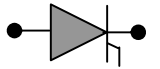

All dimensions in mm



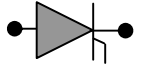

On State Power Loss

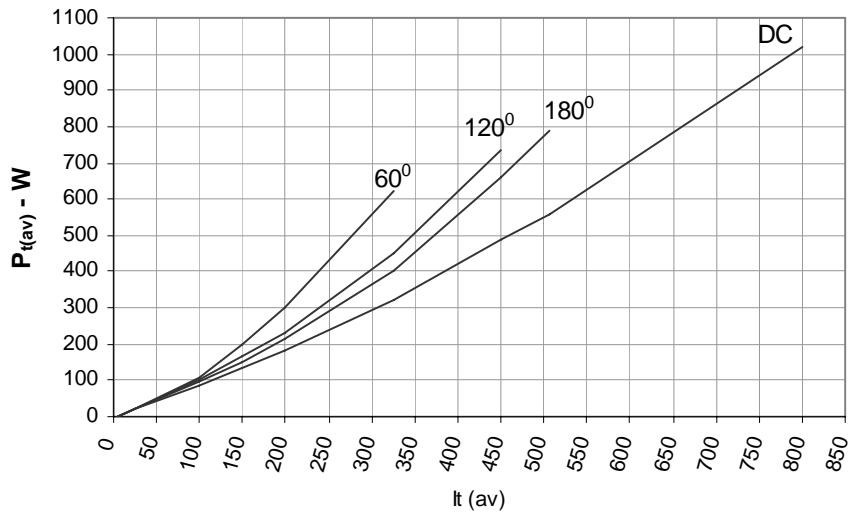

Maximum Permissible Case Temp

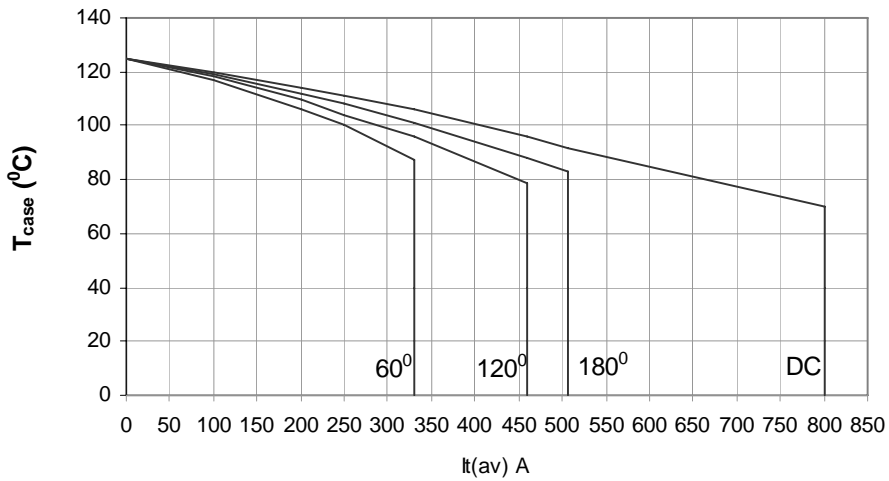

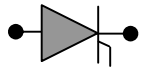

Max non repetitive Surge Current

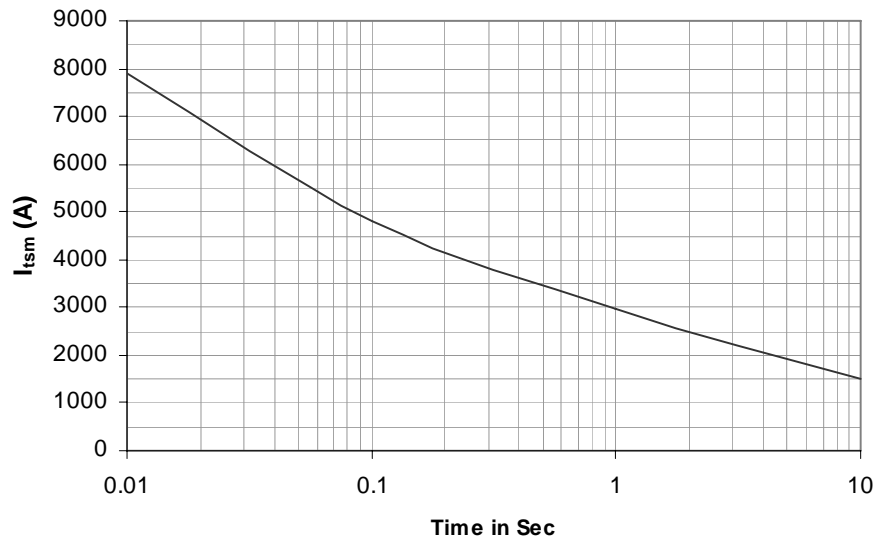

Transient Thermal Impedance Junction to Case

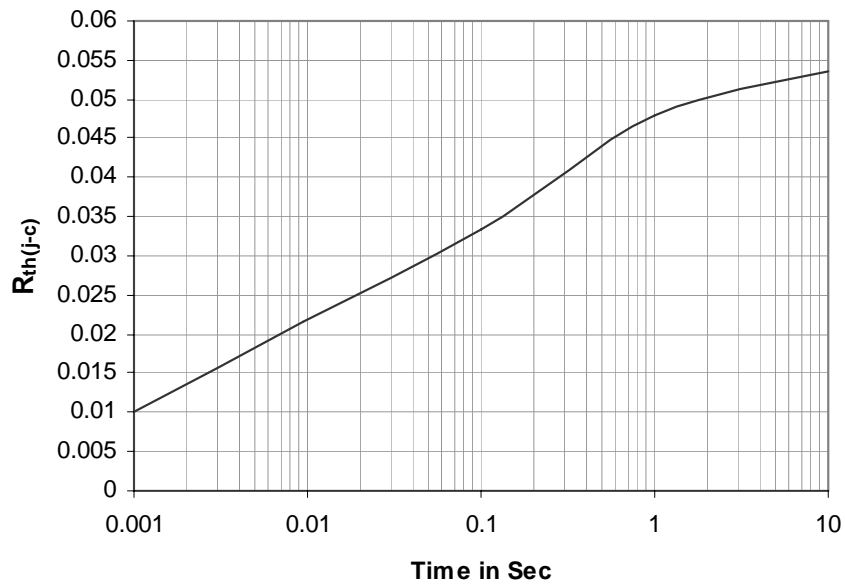

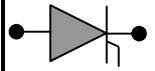

On State Characteristics

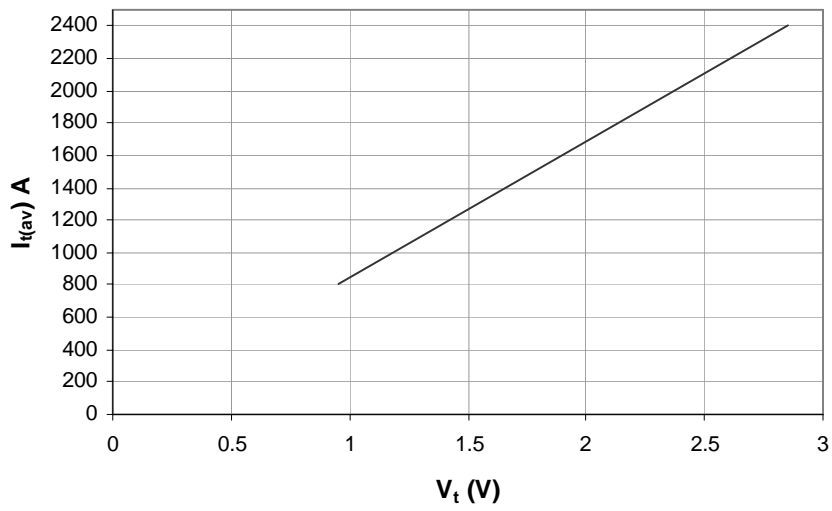

Gate Trigger Characteristics

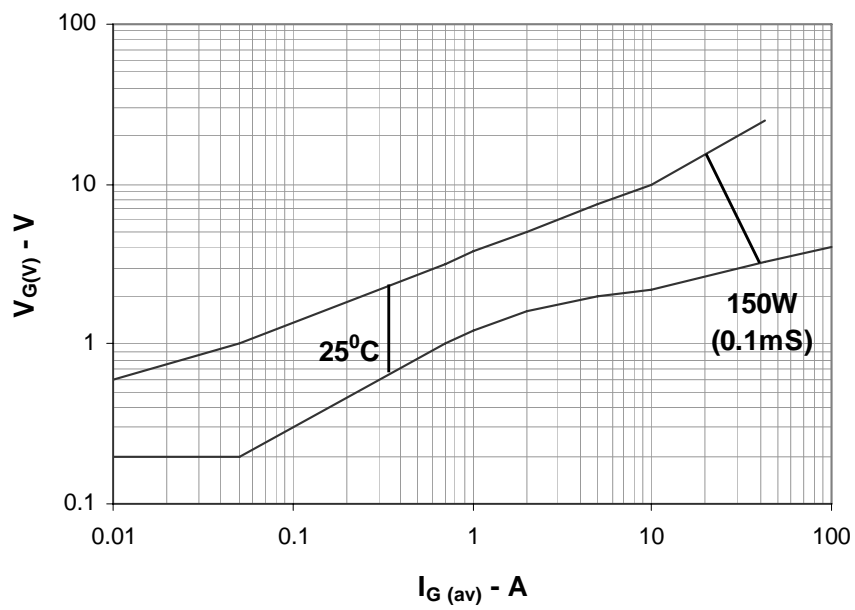

PHASE CONTROL THYRISTOR H507CHXX

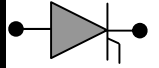

Ordering Information: -

H	507	CH	XX
Hirect make Thyristor	$I_{F(AV)} = 507A$	Capsule Thyristor	$V_{RRM} = XX * 100$ e.g. $12 * 100 = 1200V$

Hind Rectifiers Ltd reserves the right to change the specifications without notice.

This datasheet specifies technical information for semiconductor devices but promises no characteristics. No warranty or guarantee expressed or implied is made regarding delivery, performance or suitability.

Hind Rectifiers Ltd
Lake Road
Bhandup (West)
Mumbai – 400 078
Tel: - +91 22 2596 8027/28/29/31
Fax: - +91 22 2596 4114
E-mail: - marketing@hirect.com
Website: - www.hirect.com

June-2008



HIND RECTIFIERS LTD

6 of 6