

### ■ Features :

- Universal AC input/Full range
- Low leakage current<0.5mA
- Protections:Short circuit/Over load/Over voltage
- Cooling by free air convection
- 100% full load burn-in test
- Fixed switching frequency at 65KHz
- 2 years warranty

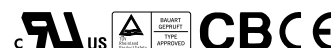

### SPECIFICATION

MODEL	PS-45-3.3	PS-45-5	PS-45-7.5	PS-45-12	PS-45-13.5	PS-45-15	PS-45-24	PS-45-27	PS-45-48		
OUTPUT	DC VOLTAGE	3.3V	5V	7.5V	12V	13.5V	15V	24V	27V	48V	
	RATED CURRENT	8A	8A	5.4A	3.7A	3.3A	3A	1.9A	1.7A	1A	
	CURRENT RANGE	0 ~ 10.7A	0 ~ 10.5A	0 ~ 7A	0 ~ 4.4A	0 ~ 3.9A	0 ~ 3.5A	0 ~ 2.2A	0 ~ 1.95A	0 ~ 1.1A	
	RATED POWER	26.4W	40W	40.5W	44.4W	44.6W	45W	45.6W	45.9W	48W	
	OUTPUT POWER (max.)	Rated output power for convection; 52W (+3.3V : 35W) with 18 CFM min.									
	RIPPLE & NOISE (max.) Note.2	80mVp-p	100mVp-p	100mVp-p	100mVp-p	100mVp-p	100mVp-p	100mVp-p	100mVp-p	100mVp-p	100mVp-p
	VOLTAGE ADJ. RANGE	3.14 ~ 3.63V	4.75 ~ 5.5V	7.13 ~ 8.25V	11.4 ~ 13.2V	12.8 ~ 14.85V	14.25 ~ 16.5V	22.8 ~ 26.4V	25.65 ~ 29.7V	45.6 ~ 52.8V	
	VOLTAGE TOLERANCE Note.3	±3.0%	±3.0%	±3.0%	±2.0%	±2.0%	±2.0%	±2.0%	±2.0%	±2.0%	
	LINE REGULATION	±1.0%	±1.0%	±1.0%	±1.0%	±1.0%	±1.0%	±1.0%	±1.0%	±1.0%	
	LOAD REGULATION	±3.0%	±3.0%	±3.0%	±2.0%	±2.0%	±2.0%	±2.0%	±2.0%	±2.0%	
SETUP, RISE TIME	800ms, 30ms at full load										
HOLD TIME (Typ.)	60ms at full load										
INPUT	VOLTAGE RANGE	90 ~ 264VAC		127 ~ 370VDC							
	FREQUENCY RANGE	47 ~ 440Hz									
	EFFICIENCY(Typ.)	69%	74%	75%	76%	77%	77%	78%	78%	78%	
	AC CURRENT (Typ.)	0.8A/115VAC		0.56A/230VAC							
	INRUSH CURRENT (Typ.)	COLD START 15A/115VAC		30A/230VAC							
LEAKAGE CURRENT	<0.75mA / 240VAC										
PROTECTION	OVER LOAD	53 ~ 75W(3.3V : 36 ~ 55W) rated output power Protection type : Hiccup mode, recovers automatically after fault condition is removed.									
	OVER VOLTAGE	3.8 ~ 4.46V	5.75 ~ 6.75V	8.63 ~ 10.1V	13.8 ~ 16.2V	15.5 ~ 18.2V	17.25 ~ 20.25V	27.6 ~ 32.4V	31 ~ 36.45V	55.2 ~ 64.8V	
ENVIRONMENT	WORKING TEMP.	-10 ~ +60°C (Refer to output load derating curve)									
	WORKING HUMIDITY	20 ~ 90% RH non-condensing									
	STORAGE TEMP., HUMIDITY	-20 ~ +85°C, 10 ~ 95% RH									
	TEMP. COEFFICIENT	±0.05%/°C (0 ~ 50°C)									
	VIBRATION	10 ~ 500Hz, 2G 10min./1cycle, Period for 60min.each along X, Y, Z axes									
SAFETY & EMC (Note 4)	SAFETY STANDARDS	UL60950, TUV EN60950-1 Approved									
	WITHSTAND VOLTAGE	I/P-O/P:3KVAC		I/P-FG:1.5KVAC		O/P-FG:0.5KVAC					
	ISOLATION RESISTANCE	I/P-O/P, I/P-FG, O/P-FG:100M Ohms/500VDC									
	EMI CONDUCTION & RADIATION	Compliance to EN55022 (CISPR22) Class B									
	HARMONIC CURRENT	Compliance to EN61000-3-2,-3									
EMS IMMUNITY	Compliance to EN61000-4-2,3,4,5,6,8,11; ENV50204, EN55024, Light industry level, criteria A										
OTHERS	MTBF	300.7K hrs min. MIL-HDBK-217F (25°C)									
	DIMENSION	127*76.2*28mm (L*W*H)									
	PACKING	0.19Kg; 72pcs/15.6Kg/1.35CUFT									
NOTE	<ol style="list-style-type: none"> <li>1. All parameters NOT specially mentioned are measured at 230VAC input, rated load and 25°C of ambient temperature.</li> <li>2. Ripple &amp; noise are measured at 20MHz of bandwidth by using a 12" twisted pair-wire terminated with a 0.1uf &amp; 47uf parallel capacitor.</li> <li>3. Tolerance : includes set up tolerance, line regulation and load regulation.</li> <li>4. The power supply is considered a component which will be installed into a final equipment. The final equipment must be re-confirmed that it still meets EMC directives.</li> <li>5. Mounting holes M1 and M2 should be grounded for EMI purposes.</li> </ol>										

### Mechanical Specification

Unit:mm

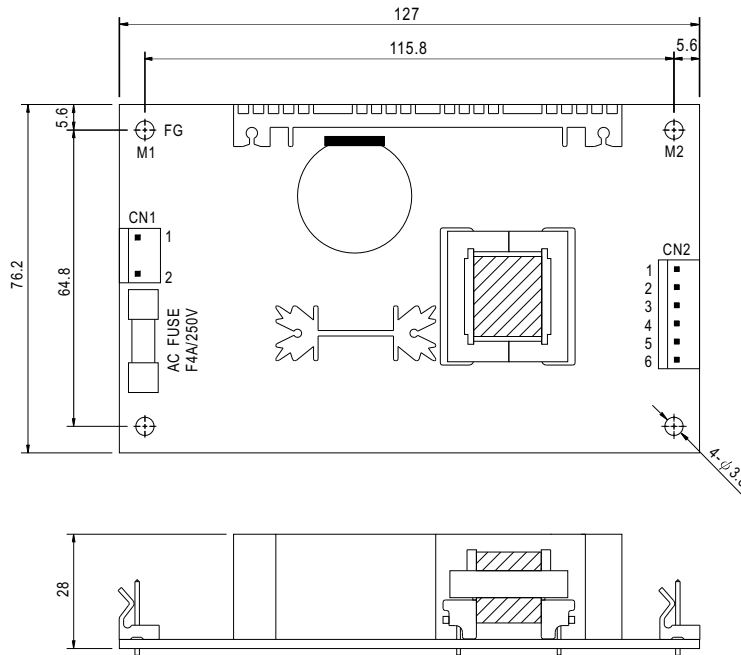

AC Input Connector (CN1) : Molex 5277-02 or equivalent

Pin No.	Assignment	Mating Housing	Terminal
1	AC/N	Molex 5195 or equivalent	Molex 5194 or equivalent
2	AC/L		

DC Output Connector (CN2) : Molex 5273-06 or equivalent

Pin No.	Assignment	Mating Housing	Terminal
1,2,3	+V	Molex 5195 or equivalent	Molex 5194 or equivalent
4,5,6	-V		

### Block Diagram

fosc : 65KHz

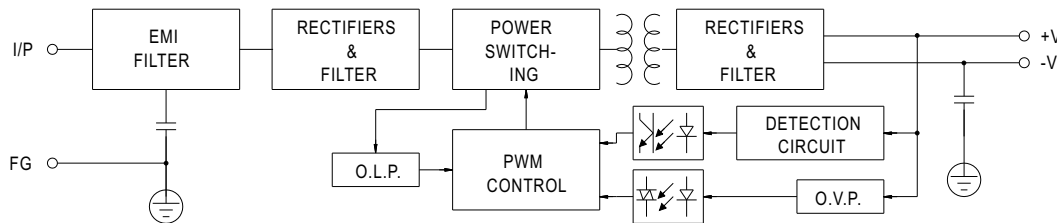

### Output Derating

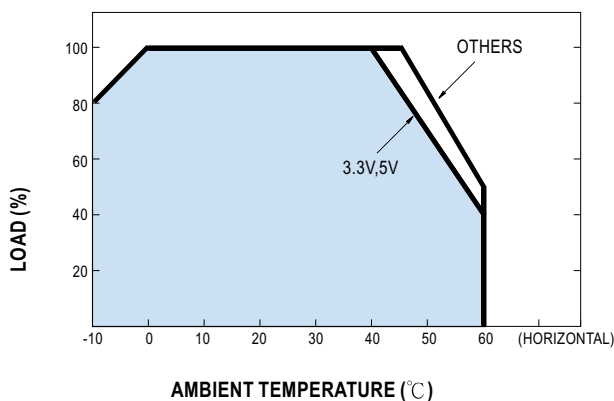

### Static Characteristics (12V)

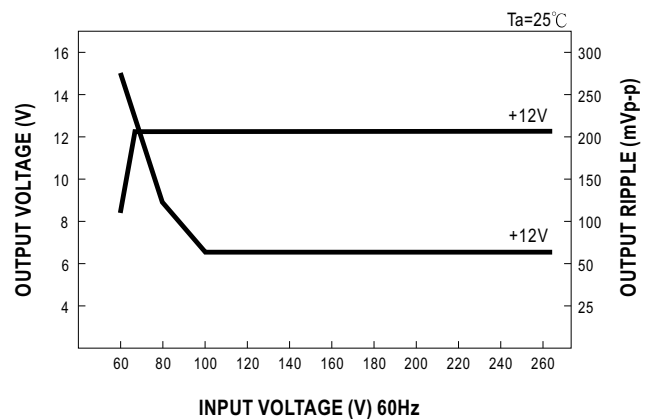

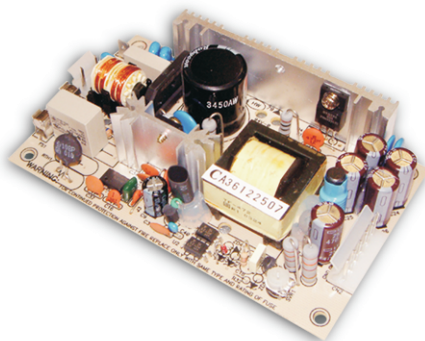

### ■ Features :

- Universal AC input/Full range
- Low leakage current<0.5mA
- Protections:Short circuit/Over load/Over voltage
- Cooling by free air convection
- 100% full load burn-in test
- Fixed switching frequency at 65KHz
- 2 years warranty

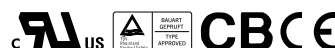

### SPECIFICATION

MODEL		PD-45A		PD-45B	
OUTPUT	OUTPUT NUMBER	CH1	CH2	CH1	CH2
	DC VOLTAGE	5V	12V	5V	24V
	RATED CURRENT	3.2A	2A	3.2A	1.2A
	CURRENT RANGE	0.4 ~ 5A	0.2 ~ 2.5A	0.4 ~ 5A	0.2 ~ 1.8A
	RATED POWER	40W		44.8W	
	OUTPUT POWER (max.)	Rated output power for convection; 52W with 18CFM min. Forced air			
	RIPPLE & NOISE (max.) Note.2	50mVp-p		120mVp-p	
	VOLTAGE ADJ. RANGE	CH1:4.75 ~ 5.5V		CH1:4.75 ~ 5.5V	
	VOLTAGE TOLERANCE Note.3	±4.0%	±7.0%	±4.0%	±7.0%
	LINE REGULATION	±1.0%	±2.0%	±1.0%	±2.0%
	LOAD REGULATION	±3.0%	±4.0%	±3.0%	±4.0%
	SETUP, RISE TIME	800ms, 20ms at full load			
HOLD TIME (Typ.)	60ms at full load				
INPUT	VOLTAGE RANGE	90 ~ 264VAC	127 ~370VDC		
	FREQUENCY RANGE	47 ~ 440Hz			
	EFFICIENCY(Typ.)	77%		78%	
	AC CURRENT (Typ.)	1A/115VAC	0.7A/230VAC		
	INRUSH CURRENT (Typ.)	COLD START 15A/115VAC	30A/230VAC		
	LEAKAGE CURRENT	<0.5mA			
PROTECTION	OVER LOAD	53 ~ 75W rated output power Protection type : Hiccup mode, recovers automatically after fault condition is removed.			
	OVER VOLTAGE	5.75 ~ 6.75VDC on CH1 Protection type : Hiccup mode, recovers automatically after fault condition is removed.			
ENVIRONMENT	WORKING TEMP.	-10 ~ +60°C (Refer to output load derating curve)			
	WORKING HUMIDITY	20 ~ 90% RH non-condensing			
	STORAGE TEMP., HUMIDITY	-20 ~ +85°C, 10 ~ 95% RH			
	TEMP. COEFFICIENT	±0.04%/°C (0 ~ 50°C) on +5V output			
	VIBRATION	10 ~ 500Hz, 2G 10min./1cycle, Period for 60min.each along X, Y, Z axes			
SAFETY & EMC (Note 4)	SAFETY STANDARDS	UL60950, TUV EN60950-1 Approved			
	WITHSTAND VOLTAGE	I/P-O/P:3KVAC I/P-FG:1.5KVAC O/P-FG:0.5KVAC			
	ISOLATION RESISTANCE	I/P-O/P, I/P-FG, O/P-FG:100M Ohms/500VDC			
	EMI CONDUCTION & RADIATION	Compliance to EN55022 (CISPR22) Class B			
	HARMONIC CURRENT	Compliance to EN61000-3-2,-3			
	EMS IMMUNITY	Compliance to EN61000-4-2,3,4,5,6,8,11; ENV50204, EN55024, Light industry level, criteria A			
OTHERS	MTBF	288.1K hrs min. MIL-HDBK-217F (25°C)			
	DIMENSION	127*76.2*28mm (L*W*H)			
	PACKING	0.2Kg; 72pcs/16Kg/1.35CUFT			
NOTE	<ol style="list-style-type: none"> <li>1. All parameters NOT specially mentioned are measured at 230VAC input, rated load and 25°C of ambient temperature.</li> <li>2. Ripple &amp; noise are measured at 20MHz of bandwidth by using a 12" twisted pair-wire terminated with a 0.1uf &amp; 47uf parallel capacitor.</li> <li>3. Tolerance : includes set up tolerance, line regulation and load regulation.</li> <li>4. The power supply is considered a component which will be installed into a final equipment. The final equipment must be re-confirmed that it still meets EMC directives.</li> <li>5. Mounting holes M1 and M2 should be grounded for EMI purposes.</li> </ol>				

### Mechanical Specification

Unit:mm

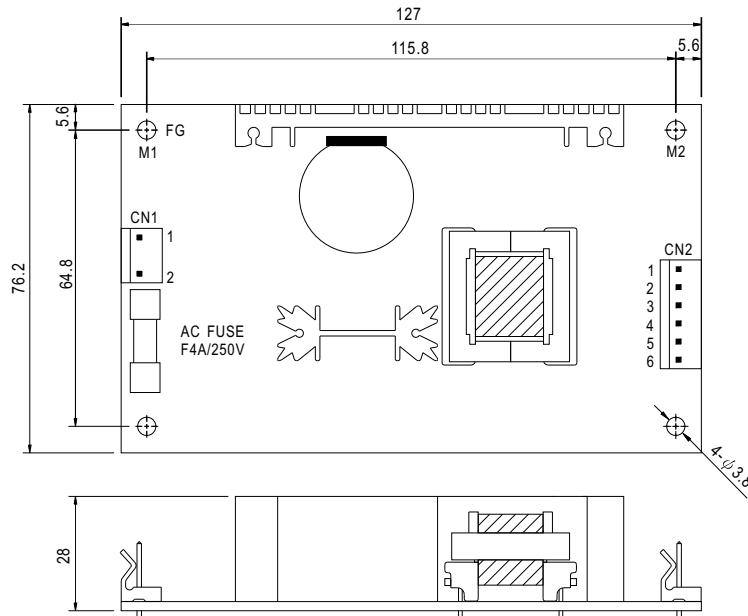

AC Input Connector (CN1) : Molex 5277-02 or equivalent

Pin No.	Assignment	Mating Housing	Terminal
1	AC/N	Molex 5195 or equivalent	Molex 5194 or equivalent
2	AC/L		

DC Output Connector (CN2) : Molex 5273-06 or equivalent

Pin No.	Assignment	Mating Housing	Terminal
1	+V	Molex 5195 or equivalent	Molex 5194 or equivalent
2,3	+5V		
4,5	COM		
6	NC		

### Block Diagram

fosc : 65KHz

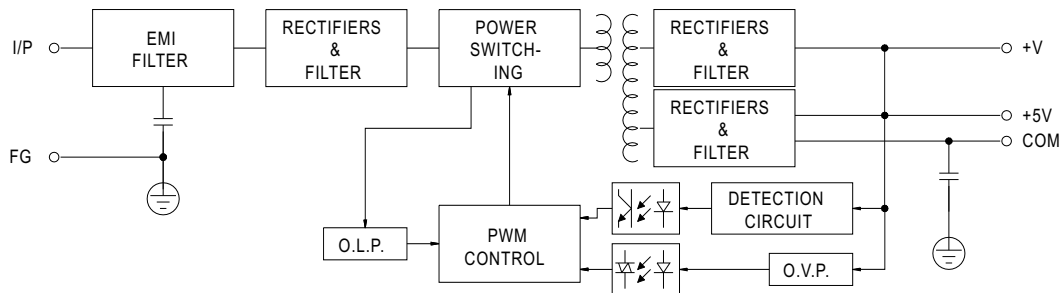

### Output Derating

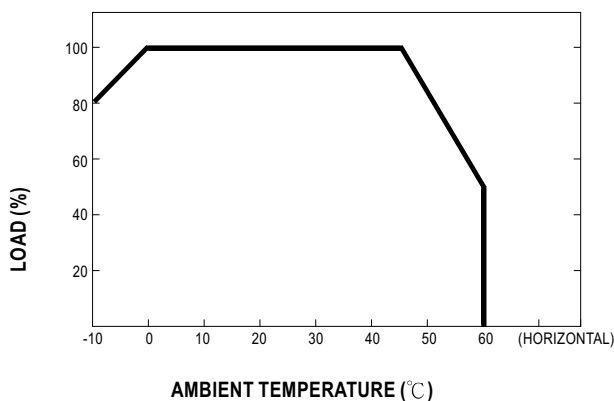

### Static Characteristics (A)

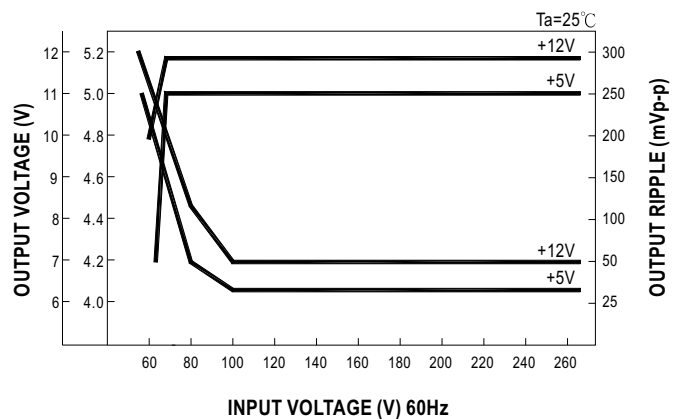

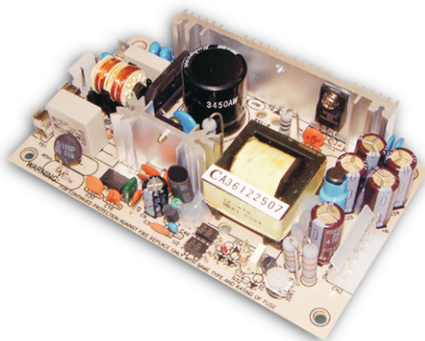

### ■ Features :

- Universal AC input/Full range
- Low leakage current<0.5mA
- Protections:Short circuit/Over load/Over voltage
- Cooling by free air convection
- 100% full load burn-in test
- Fixed switching frequency at 65KHz
- 2 years warranty

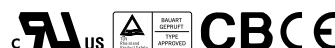

### SPECIFICATION

MODEL		PT-45A			PT-45B			PT-45C		
OUTPUT	OUTPUT NUMBER	CH1	CH2	CH3	CH1	CH2	CH3	CH1	CH2	CH3
	DC VOLTAGE	5V	12V	-5V	5V	12V	-12V	5V	15V	-15V
	RATED CURRENT	3A	2A	0.3A	3A	2A	0.3A	3A	1.6A	0.3A
	CURRENT RANGE	0.4 ~ 5A	0.2 ~ 2.5A	0 ~ 0.5A	0.4 ~ 5A	0.2 ~ 2.5A	0 ~ 0.5A	0.4 ~ 5A	0.2 ~ 2.3A	0 ~ 0.5A
	RATED POWER	40.5W			42.6W			43.5W		
	OUTPUT POWER (max.)	Rated output power for convection; 52W with 18CFM min. Forced air								
	RIPPLE & NOISE (max.) Note.2	50mVp-p	120mVp-p	50mVp-p	50mVp-p	120mVp-p	100mVp-p	50mVp-p	120mVp-p	100mVp-p
	VOLTAGE ADJ. RANGE	CH1:4.75 ~ 5.5V								
	VOLTAGE TOLERANCE Note.3	±4.0%	±7.0%	±5.0%	±4.0%	±7.0%	±5.0%	±4.0%	±7.0%	±5.0%
	LINE REGULATION	±1.0%	±2.0%	±1.0%	±1.0%	±2.0%	±1.0%	±1.0%	±2.0%	±1.0%
	LOAD REGULATION	±3.0%	±4.0%	±1.0%	±3.0%	±4.0%	±1.0%	±3.0%	±4.0%	±1.0%
	SETUP, RISE TIME	800ms, 20ms at full load								
HOLD TIME (Typ.)	60ms at full load									
INPUT	VOLTAGE RANGE	90 ~ 264VAC		127 ~370VDC						
	FREQUENCY RANGE	47 ~ 440Hz								
	EFFICIENCY (Typ.)	75%			75%			75%		
	AC CURRENT (Typ.)	1A/115VAC		0.7A/230VAC						
	INRUSH CURRENT (Typ.)	COLD START 15A/115VAC			30A/230VAC					
	LEAKAGE CURRENT	<0.5mA								
PROTECTION	OVER LOAD	53 ~ 75W rated output power Protection type : Hiccup mode, recovers automatically after fault condition is removed.								
	OVER VOLTAGE	CH1: 5.75 ~ 6.75VDC Protection type : Hiccup mode, recovers automatically after fault condition is removed.								
ENVIRONMENT	WORKING TEMP.	-10 ~ +60°C (Refer to output load derating curve)								
	WORKING HUMIDITY	20 ~ 90% RH non-condensing								
	STORAGE TEMP., HUMIDITY	-20 ~ +85°C, 10 ~ 95% RH								
	TEMP. COEFFICIENT	±0.04%/°C (0 ~ 50°C) on +5V output								
	VIBRATION	10 ~ 500Hz, 2G 10min./1cycle, Period for 60min.each along X, Y, Z axes								
SAFETY & EMC (Note 4)	SAFETY STANDARDS	UL60950, TUV EN60950-1 Approved								
	WITHSTAND VOLTAGE	I/P-O/P:3KVAC I/P-FG:1.5KVAC O/P-FG:0.5KVAC 1min.								
	ISOLATION RESISTANCE	I/P-O/P, I/P-FG, O/P-FG:100M Ohms/500VDC								
	EMI CONDUCTION & RADIATION	Compliance to EN55022 (CISPR22) Class B								
	HARMONIC CURRENT	Compliance to EN61000-3-2,-3								
	EMS IMMUNITY	Compliance to EN61000-4-2,3,4,5,6,8,11; ENV50204, EN55024, Light industry level, criteria A								
OTHERS	MTBF	288.1K hrs min. MIL-HDBK-217F (25°C)								
	DIMENSION	127*76.2*28mm (L*W*H)								
	PACKING	0.21Kg; 72pcs/17Kg/1.35CUFT								
NOTE	<ol style="list-style-type: none"> <li>1. All parameters NOT specially mentioned are measured at 230VAC input, rated load and 25°C of ambient temperature.</li> <li>2. Ripple &amp; noise are measured at 20MHz of bandwidth by using a 12" twisted pair-wire terminated with a 0.1uf &amp; 47uf parallel capacitor.</li> <li>3. Tolerance : includes set up tolerance, line regulation and load regulation.</li> <li>4. The power supply is considered a component which will be installed into a final equipment. The final equipment must be re-confirmed that it still meets EMC directives.</li> <li>5. Mounting holes M1 and M2 should be grounded for EMI purposes.</li> </ol>									

### Mechanical Specification

Unit:mm

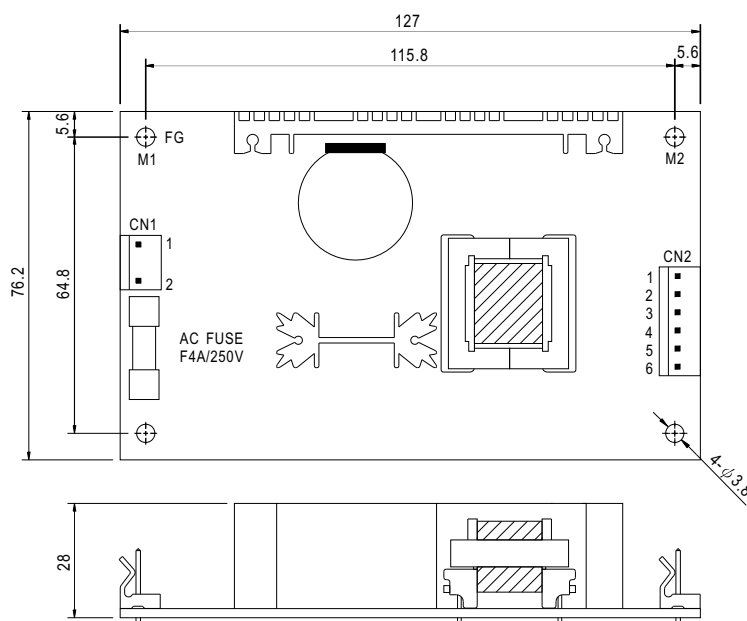

AC Input Connector (CN1) : Molex 5277-02 or equivalent

Pin No.	Assignment	Mating Housing	Terminal
1	AC/N	Molex 5195 or equivalent	Molex 5194 or equivalent
2	AC/L		

DC Output Connector (CN2) : Molex 5273-06 or equivalent

Pin No.	Assignment	Mating Housing	Terminal
1	+V	Molex 5195 or equivalent	Molex 5194 or equivalent
2,3	+5V		
4,5	COM		
6	-V		

### Block Diagram

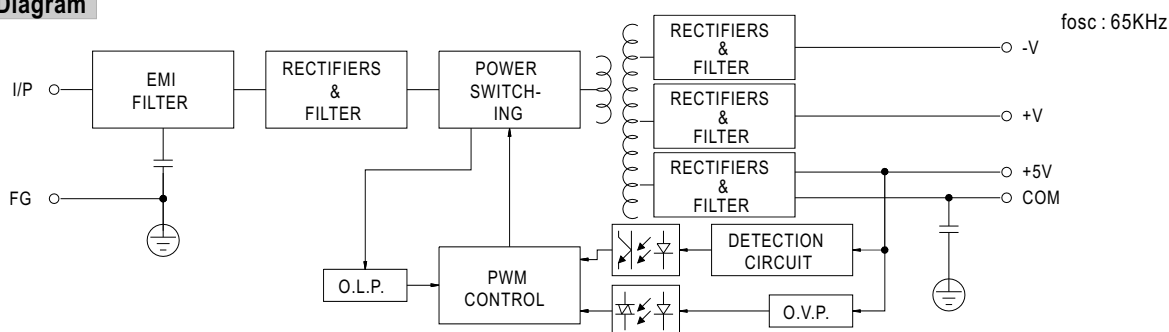

### Output Derating

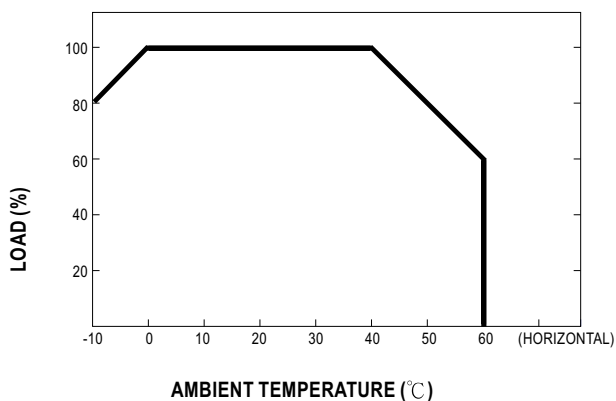

### Static Characteristics (B)

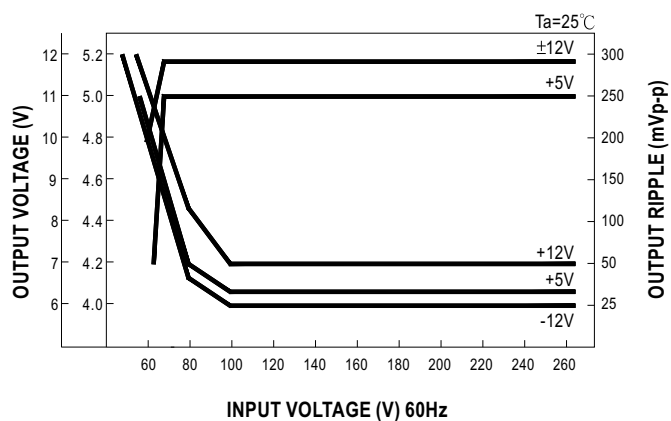

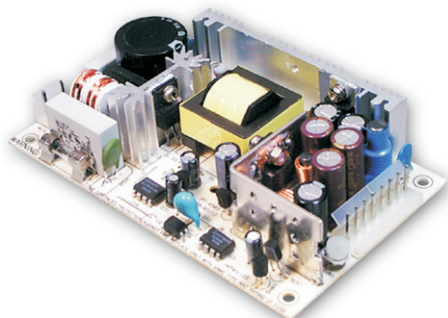

### ■ Features :

- Universal AC input / Full range
- Protections: Short circuit/Over load/Over voltage
- Cooling by free air convection
- 100% full load burn-in test
- Fixed switching frequency at 65KHz
- 2 years warranty

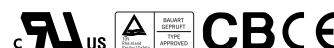

### SPECIFICATION

MODEL		PT-4503		
OUTPUT	OUTPUT NUMBER	CH1	CH2	CH3
	DC VOLTAGE	3.3V	5V	12V
	RATED CURRENT	4A	4A	1A
	CURRENT RANGE	0 ~ 5A	0.2 ~ 7A	0 ~ 1.2A
	RATED POWER	Total power max. 45.2W(CH1+CH2 max. 35W)		
	RIPPLE & NOISE (max.) Note.2	50mVp-p	50mVp-p	100mVp-p
	VOLTAGE ADJ. RANGE	CH1: 3 ~ 3.6V		
	VOLTAGE TOLERANCE Note.3	±2.0%	+4,-2%	±8.0%
	LINE REGULATION	±1.0%		±2.0%
	LOAD REGULATION	±2.0%	±2.0%	±8.0%
SETUP, RISE TIME	800ms, 50ms at full load			
HOLD TIME (Typ.)	60ms at full load			
INPUT	VOLTAGE RANGE	90 ~ 264VAC	127 ~ 370VDC	
	FREQUENCY RANGE	47 ~ 63Hz		
	EFFICIENCY (Typ.)	72%		
	AC CURRENT (Typ.)	1.2A/115VAC	0.7A/230VAC	
	INRUSH CURRENT (Typ.)	COLD START 20A/115V	40A/230V	
LEAKAGE CURRENT	<1mA / 240VAC			
PROTECTION	OVER LOAD	120 ~ 160% rated output power Protection type : Hiccup mode, recovers automatically after fault condition is removed		
	OVER VOLTAGE	5.75 ~ 6.75V on +5V Protection type : Hiccup mode, recovers automatically after fault condition is removed		
ENVIRONMENT	WORKING TEMP.	-10 ~ +60°C (Refer to output load derating curve)		
	WORKING HUMIDITY	20 ~ 90% RH non-condensing		
	STORAGE TEMP., HUMIDITY	-20 ~ +85°C, 10 ~ 95% RH		
	TEMP. COEFFICIENT	±0.03%/°C (0 ~ 50°C)		
VIBRATION	10 ~ 500Hz, 2G 10min./1cycle, Period for 60min.each along X, Y, Z axes			
SAFETY & EMC (Note 4)	SAFETY STANDARDS	UL60950-1, TUV EN60950-1 Approved		
	WITHSTAND VOLTAGE	I/P-O/P:3KVAC I/P-FG:1.5KVAC O/P-FG:0.5KVAC 1min.		
	ISOLATION RESISTANCE	I/P-O/P, I/P-FG, O/P-FG:100M Ohms/500VDC		
	EMI CONDUCTION & RADIATION	Compliance to EN55022 (CISPR22) Class B		
	HARMONIC CURRENT	Compliance to EN61000-3-2,-3		
EMS IMMUNITY	Compliance to EN61000-4-2,3,4,5,6,11 Light industry level, criteria A			
OTHERS	MTBF	220.9Khrs min. MIL-HDBK-217F (25°C)		
	DIMENSION	127*76.2*28mm (L*W*H)		
	PACKING	0.23Kg; 72pcs/17.6Kg/1.35CUFT		
NOTE	<ol style="list-style-type: none"> <li>1. All parameters NOT specially mentioned are measured at 230VAC input, rated load and 25°C of ambient temperature.</li> <li>2. Ripple &amp; noise are measured at 20MHz of bandwidth by using a 12" twisted pair-wire terminated with a 0.1uf &amp; 47uf parallel capacitor.</li> <li>3. Tolerance : includes set up tolerance, line regulation and load regulation.</li> <li>4. The power supply is considered a component which will be installed into a final equipment. The final equipment must be re-confirmed that it still meets EMC directives.</li> <li>5. Mounting holes M1 and M2 should be grounded for EMI purposes.</li> </ol>			



### Mechanical Specification

Unit:mm

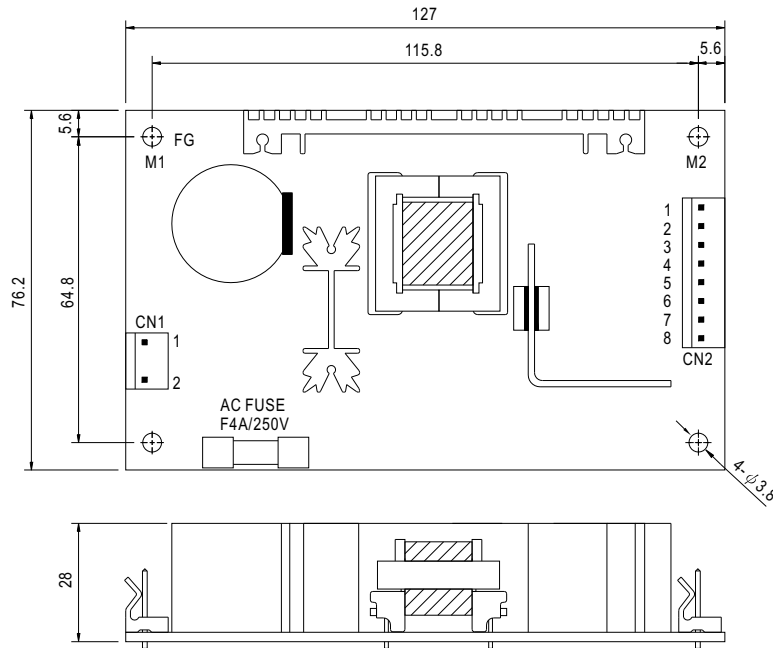

AC Input Connector (CN1) : Molex 5277-02 or equivalent

Pin No.	Assignment	Mating Housing	Terminal
1	AC/N	Molex 5195 or equivalent	Molex 5194 or equivalent
2	AC/L	Molex 5195 or equivalent	Molex 5194 or equivalent

DC Output Connector (CN2) : Molex 5273-08 or equivalent

Pin No.	Assignment	Mating Housing	Terminal
1,2	+5V	Molex 5195 or equivalent	Molex 5194 or equivalent
3,4,5	COM		
6	+V		
7,8	+3.3V		

### Block Diagram

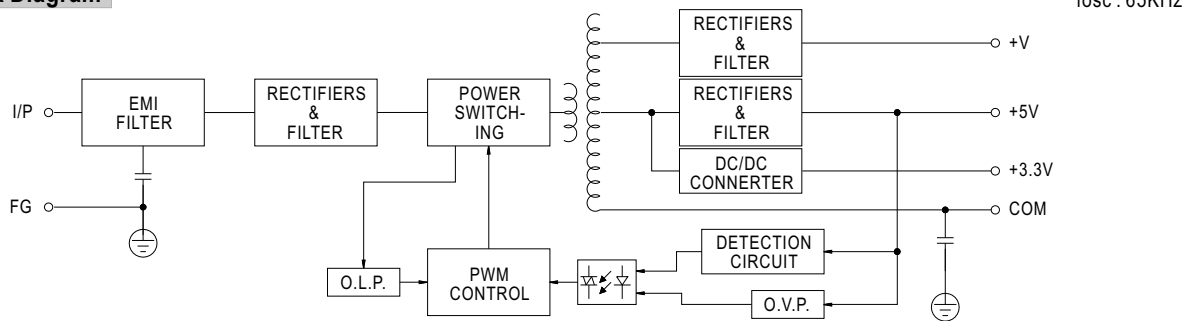

### Output Derating

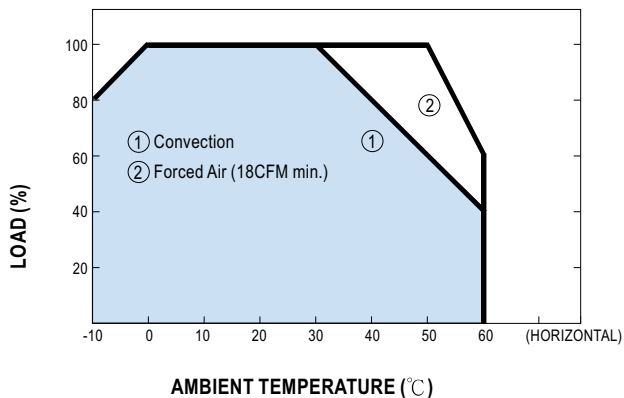

### Static Characteristics

