

48Vin
Input

53Vout
Output

7.6Amp
Current

2250Vdc
Isolation

Half-brick
DC/DC Converter

The PQ55530HEB08 PowerQor® Exa converter is an isolated, fixed switching frequency DC/DC converter that uses synchronous rectification to achieve extremely high efficiency and power density. This module is ideally suited to support the IEEE 802.3af standard for Power Over LAN and VoIP applications. The 53Vout modules feature 2,250Vdc isolation and low common mode noise. The Exa series converters offer industry leading useable output power for any standard "half-brick" module. RoHS compliant (see page 13).

PowerQor® Exa

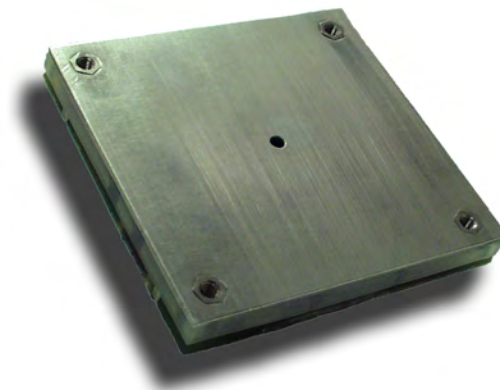

PQ55530HEB08 Module

Operational Features

- Ultra-high efficiency, 95% at full rated load current
- Delivers up to 400 Watts of output power with minimal derating - optional open frame unit available
- Input voltage range: 38V – 55V, with 80V for 100ms input transient capability
- Fixed frequency switching provides predictable EMI performance
- On-board input and output filtering

Mechanical Features

- Industry standard half-brick pin-out configuration
- Industry standard size: 2.3" x 2.4" (58.4 x 61.0mm)
- Total height only 0.50" (12.7mm) for baseplated unit, open-frame only 0.420" (10.67mm)
- Total weight: 4.3 oz. (123 grams) for baseplated unit, open-frame 2.6oz. (75 grams)

Control Features

- On/Off control referenced to input side (positive and negative logic options are available)
- Remote sense for the output voltage compensates for output distribution drops
- Output voltage trim permits custom voltages and voltage margining

Protection Features

- Input under-voltage lockout disables converter at low input voltage conditions
- Output current limit and short circuit protection protects converter and load from permanent damage
- Active back bias limit prevents damage to converter from external load induced pre-bias
- Latching output over-voltage protection
- Thermal shutdown

Safety Features

- 2250V, 30 MΩ input-to-output isolation
- UL/cUL 60950-1 recognized (US & Canada), basic insulation rating
- TUV certified to EN60950-1
- Meets 72/23/EEC and 93/68/EEC directives
- Meets UL94V-0 flammability requirements

Input: 38-55 V
Output: 53 V
Current: 7.6 A
Package: Half-brick

MECHANICAL DIAGRAM (base-plated)

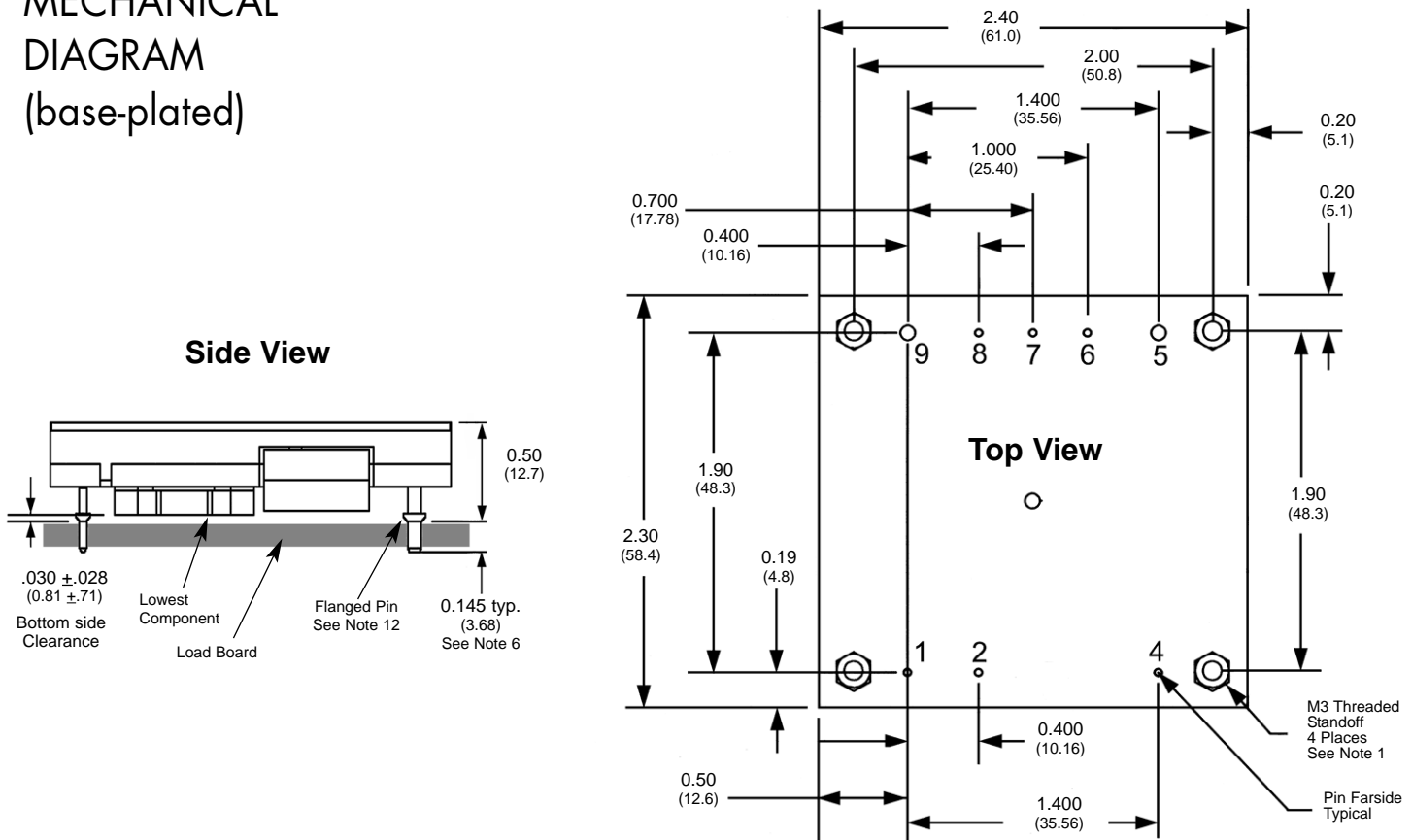

NOTES

- 1) M3 screws used to bolt unit's baseplate to other surfaces (such as heatsink) must not exceed 0.100" (2.54 mm) depth below the surface of the baseplate.
- 2) Applied torque per screw should not exceed 6in-lb. (0.7 Nm)
- 3) Baseplate flatness tolerance is 0.004" (.10mm) TIR for surface
- 4) Pins 1, 2, 4, 6-8, are 0.040" (1.02mm) diameter with 0.080" (2.03mm) diameter standoff shoulders
- 5) Pins 5, 9 are 0.080" (2.03mm) diameter shoulderless pins.
- 6) Other pin extension lengths available
- 7) All Pins: Material - Copper Alloy
 Finish (RoHS 5/6) - Tin/Lead over Nickel plate
 Finish (RoHS 6/6) - Matte Tin over Nickel plate
- 8) Undimensioned components are shown for visual reference only.
- 9) Weight: 4.3 oz. (123 g) typical
- 10) All dimensions in inches (mm)
 Tolerances: x.xx +/-0.02 in. (x.x +/-0.5mm)
 x.xxx +/-0.010 in. (x.xx +/-0.25mm)
- 11) Workmanship: Meets or exceeds IPC-A-610C Class II
- 12) For information regarding soldering and cleaning of base-plated units please refer to the "[Base-Plate Soldering & Cleaning product advisory](#)" on our website's [Technical Documents](#) page.

PIN DESIGNATIONS

Pin No.	Name	Function
1	Vin(+)	Positive input voltage
2	ON/OFF	TTL input to turn converter on and off, referenced to Vin(-), with internal pull up.
4	Vin(-)	Negative input voltage
5	Vout(-)	Negative output voltage
6	SENSE(-)	Return remote sense
7	TRIM	Output voltage trim
8	SENSE(+)	Positive remote sense
9	Vout(+)	Positive output voltage

Notes:

1. SENSE(-) should be connected to Vout(-) either remotely or at the converter.
2. Leave TRIM pin open for nominal output voltage.
3. SENSE(+) should be connected to Vout(+) either remotely or at the converter.

MECHANICAL DIAGRAM (open frame)

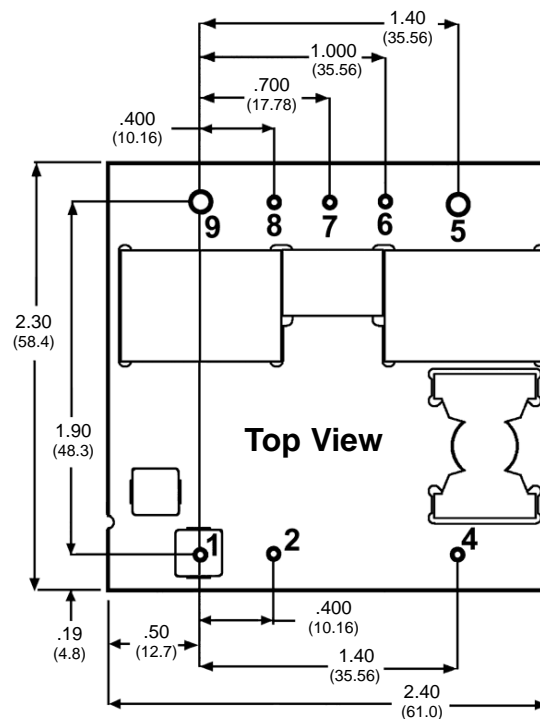
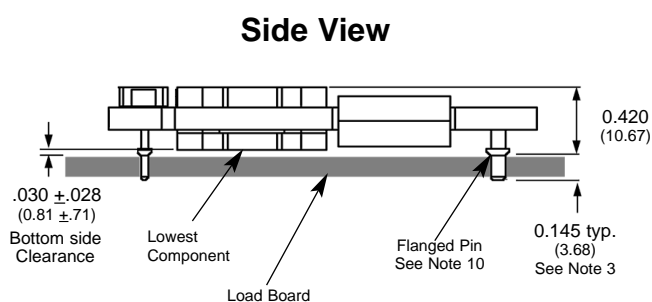

NOTES

- 1) Pins 1-4, 6-8 are 0.040" (1.02mm) diameter. with 0.080" (2.03mm) diameter standoff shoulders.
- 2) Pins 5 and 9 are 0.080" (2.03 mm) diameter with 0.125" (3.18mm) diameter standoff shoulders.
- 3) Other pin extension lengths available. Recommended pin length is 0.03" (0.76mm) greater than the PCB thickness.
- 4) All Pins: Material - Copper Alloy
 Finish (RoHS 5/6) - Tin/Lead over Nickel plate
 Finish (RoHS 6/6) - Matte Tin over Nickel plate
- 5) Undimensioned components are shown for visual reference only.
- 6) All dimensions in inches (mm)
 Tolerances: x.xx +/-0.02 in. (x.x +/-0.5mm)
 x.xxx +/-0.010 in. (x.xx +/-0.25mm)
- 7) Weight: 2.6 oz. (75 g) typical
- 8) Workmanship: Meets or exceeds IPC-A-610C Class II
- 9) UL/TUV standards require a clearance greater than 0.04" (1.02mm) between input and output for Basic insulation. This issue should be considered if any copper traces are on the top side of the user's board. Note that the ferrite cores are considered part of the input/primary circuit.
- 10) The flanged pins are designed to permit surface mount soldering (avoiding the wave soldering process) through the use of the flanged pin-in-paste technique.

PIN DESIGNATIONS

Pin connections are identical to baseplated version shown on page 2. Use "A" as 10th letter in part number for open frame version (see [ordering page](#)).

PQ55530HEX08 ELECTRICAL CHARACTERISTICS

T_A=25°C, airflow rate=300 LFM, V_{in}=48Vdc unless otherwise noted; full operating temperature range is -40°C to +100°C ambient temperature with appropriate power derating. Specifications subject to change without notice.

Parameter	Min.	Typ.	Max.	Units	Notes & Conditions
ABSOLUTE MAXIMUM RATINGS					
Input Voltage					
Non-Operating			80	V	Continuous
Operating			60	V	Continuous
Operating Transient Protection			80	V	100ms transient
Isolation Voltage (input to output)			2250	V	Basic insulation level, Pollution degree 2
Operating Temperature	-40		100	°C	
Storage Temperature	-55		125	°C	
Voltage at ON/OFF input pin	-2		18	V	
INPUT CHARACTERISTICS					
Operating Input Voltage Range	38	48	55	V	
Input Under-Voltage Lockout					
Turn-On Voltage Threshold	34.0	35.2	36.4	V	
Turn-Off Voltage Threshold	32.0	33.0	34.3	V	
Lockout Voltage Hysteresis		2.1		V	
Maximum Input Current			11.8	A	100% Load, 38 Vin, trim up 5%
No-Load Input Current		140		mA	
Disabled Input Current		42	68	mA	V _{in} = 38V
Inrush Current Transient Rating			0.01	A ² s	
Input Reflected Ripple Current		20	40	mA	RMS thru 4.7µH inductor; Figures 16 & 18
Input Terminal Ripple Current		130		mA	RMS; Figures 12 & 17
Recommended Input Fuse			20	A	Fast blow external fuse recommended
Input Filter Component Values (L\C)		1.0\5.0		µH\µF	Internal values; see Figure D
Recommended External Input Capacitance		100		µF	Typical ESR 0.04 -1.0Ω; see Figure 16
OUTPUT CHARACTERISTICS					
Output Voltage Set Point (standard option)	52.50	53.00	53.50	V	
Output Voltage Set Point ("A" option ³)	52.75	53.00	53.25	V	
Output Voltage Regulation					
Over Line		±0.05 \ 20	±0.1 \ 50	%\mV	
Over Load		±0.15 \ 80	±0.2 \ 105	%\mV	
Over Temperature (standard option)		±100	±158	mV	
Over Temperature ("A" option ³)		±50	±79	mV	
Total Output Voltage Range	51.95		53.95	V	Over sample, line, load, temperature & life
Output Voltage Ripple and Noise ¹					20MHz bandwidth; Figures 15 & 16
Peak-to-Peak		150		mV	Full Load; see Figures 16 & 19
RMS		20	50	mV	Full Load; see Figures 16 & 19
Operating Output Current Range	0		7.6	A	Subject to thermal derating; Figures 5, 7 - 10
Output DC Current Limit Inception	9.5	10.5	11.5	A	Output Voltage 10% Low; Figure 20
Back-Drive Current Limit while Enabled	0.5	1.38	2.0	A	54V pre-bias voltage on output
Back-Drive Current Limit while Disabled	50	90	120	mA	"
Maximum Output Capacitance			1,000	µF	53Vout at 7.6A Resistive Load
DYNAMIC CHARACTERISTICS					
Input Voltage Ripple Rejection		60		dB	120 Hz; Figure 20
Output Voltage during Load Current Transient					
For a Step Change in Output Current (0.1A/µs)		600		mV	50-75-50% Iout max; 200µF cap; Figure 13
For a Step Change in Output Current (1A/µs)		600		mV	50-75-50% Iout max; 200µF cap; Figure 14
Settling Time		600		µs	To within 0.2% Vout nom
Turn-On Transient					
Turn-On Time	15	20	28	ms	Full load, Vout=90% nom.; Figures 11 & 12
Start-Up Delay Time	4	6	8	ms	-40°C to +125°C; Figure E
Output Voltage Overshoot		0		%	1,000 µF load capacitance, Iout = 0A
EFFICIENCY					
100% Load		95		%	Figures 1 - 4
50% Load		95		%	Figures 1 - 4
TEMPERATURE LIMITS FOR POWER DERATING CURVES					
Semiconductor Junction Temperature			125	°C	Package rated to 150°C
Board Temperature			125	°C	UL rated max operating temp 130°C
Transformer Temperature			125	°C	See Figures 5, 7 - 10 for derating curves
Maximum Baseplate Temperature			100	°C	Applies to PQ55525HEB08xxx unit only
ISOLATION CHARACTERISTICS					
Isolation Voltage (dielectric strength)		2250		V	
Isolation Resistance		30		MΩ	
Isolation Capacitance ²		220		pF	

Note 1: For applications requiring reduced output voltage ripple and noise, consult SynQor applications support (e-mail: support@synqor.com)

Note 2: Higher values of isolation capacitance can be added external to the module.

Note 3: See the last page for ordering information options.

ELECTRICAL CHARACTERISTICS (Continued)

Parameter	Min.	Typ.	Max.	Units	Notes & Conditions
FEATURE CHARACTERISTICS					
Switching Frequency	275	300	325	kHz	Regulation and Isolation stages
ON/OFF Control (Option P)					
Off-State Voltage	-2		0.8	V	
On-State Voltage	2.7		18	V	
ON/OFF Control (Option N)					
Off-State Voltage	2.7		18	V	
On-State Voltage	-2		0.8	V	
ON/OFF Control (Either Option)					Figure A
Pull-Up Voltage		5	5.5	V	
Pull-Up Resistance		10		kΩ	
Output Voltage Trim Range	-50		+5	%	Measured across Pins 9 & 5; Figure B
Output Voltage Remote Sense Range			+5	%	Measured across Pins 9 & 5
Output Over-Voltage Protection	57	58.5	60	V	Over full temp range; % of nominal Vout, Latching
Over-Temperature Shutdown		125		°C	Average PCB Temperature
Over-Temperature Shutdown Restart Hysteresis		10		°C	
Load Current Scale Factor		180			See App Note: Output Load Current Calc.
RELIABILITY CHARACTERISTICS					
Calculated MTBF (Telcordia)		1.9		10 ⁶ Hrs.	TR-NWT-000332; 80% load, 300LFM, 40°C T _a
Calculated MTBF (MIL-217)		1.4		10 ⁶ Hrs.	MIL-HDBK-217F; 80% load, 300LFM, 40°C T _a
Field Demonstrated MTBF				10 ⁶ Hrs.	See our website for details

STANDARDS COMPLIANCE

Parameter	Notes
STANDARDS COMPLIANCE	
UL/cUL 60950-1	File # E194341, Basic insulation & pollution degree 2
EN60950-1	Certified by TÜV
72/23/EEC	
93/68/EEC	
Needle Flame Test (IEC 695-2-2)	Test on entire assembly; board & plastic components UL94V-0 compliant
IEC 61000-4-2	ESD test, 8kV - NP, 15kV air - NP (Normal Performance)
GR-1089-CORE	Section 7 - electrical safety, Section 9 - bonding/grounding
Telcordia (Bellcore) GR-513	

- An external input fuse must always be used to meet these safety requirements. Contact SynQor for official safety certificates on new releases or download from the [SynQor website](#).

QUALIFICATION TESTING

Parameter	# Units	Test Conditions
QUALIFICATION TESTING		
Life Test	32	95% rated V _{in} and load, units at derating point, 1000 hours
Vibration	5	10-55Hz sweep, 0.060" total excursion, 1 min./sweep, 120 sweeps for 3 axis
Mechanical Shock	5	100g minimum, 2 drops in x and y axis, 1 drop in z axis
Temperature Cycling	10	-40°C to 100°C, unit temp. ramp 15°C/min., 500 cycles
Power/Thermal Cycling	5	Toperating = min to max, V _{in} = min to max, full load, 100 cycles
Design Marginality	5	T _{min} -10°C to T _{max} +10°C, 5°C steps, V _{in} = min to max, 0-105% load
Humidity	5	85°C, 85% RH, 1000 hours, 2 minutes on and 6 hours off
Solderability	15 pins	MIL-STD-883, method 2003

- Extensive characterization testing of all SynQor products and manufacturing processes is performed to ensure that we supply robust, reliable product. Contact the factory for official product family qualification documents.

OPTIONS

SynQor provides various options for Logic Sense, Pin Length and Feature Set for this family of DC/DC converters. Please consult the [last page](#) of this specification sheet for information on available options.

PATENTS

SynQor is protected under various patents, including but not limited to U.S. Patent #s 5,999,417; 6,222,742 B1; 6,594,159 B2; 6,545,890 B2.

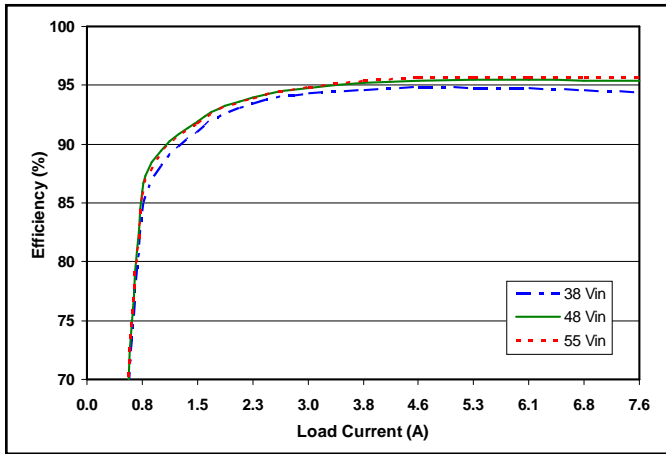

Figure 1: Efficiency at nominal output voltage vs. load current for minimum, nominal, and maximum input voltage at 25°C.

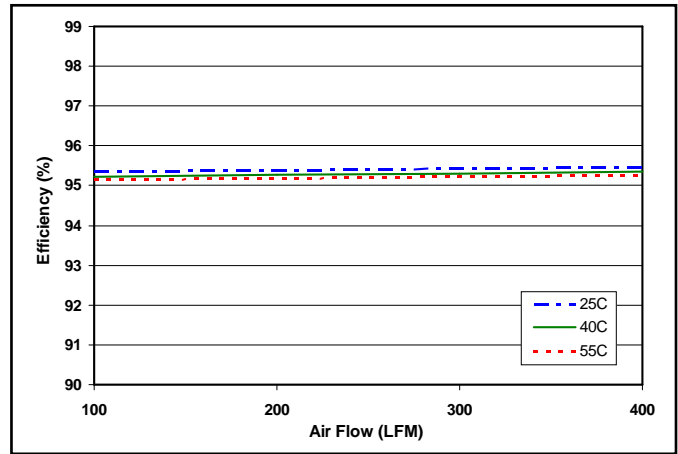

Figure 2: Efficiency at nominal output voltage and 60% rated power vs. airflow rate for ambient air temperatures of 25°C, 40°C, and 55°C (nominal input voltage).

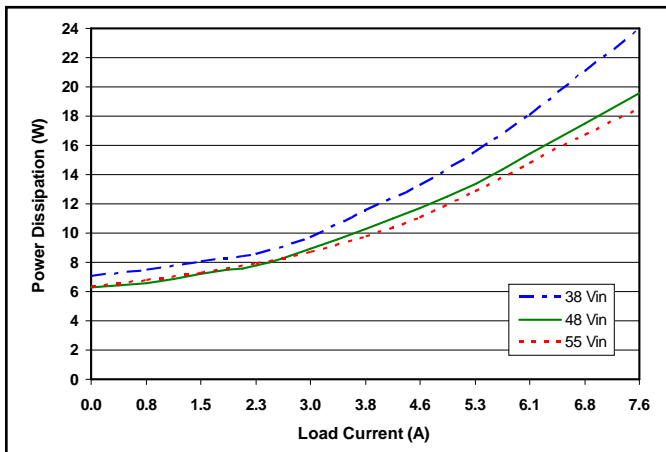

Figure 3: Power dissipation at nominal output voltage vs. load current for minimum, nominal, and maximum input voltage at 25°C.

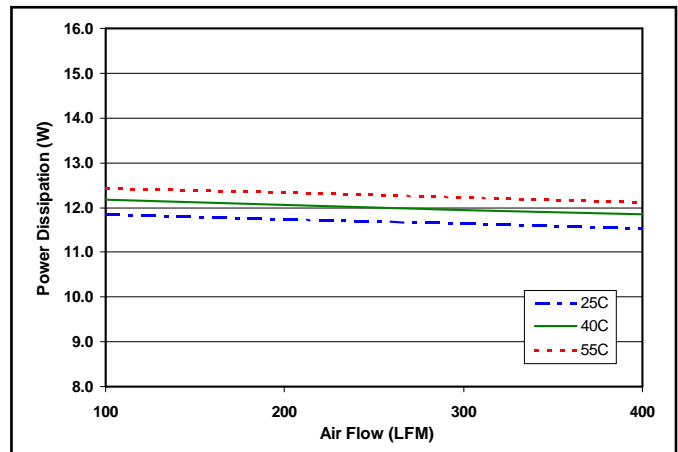

Figure 4: Power dissipation at nominal output voltage and 60% rated power vs. airflow rate for ambient air temperatures of 25°C, 40°C, and 55°C (nominal input voltage).

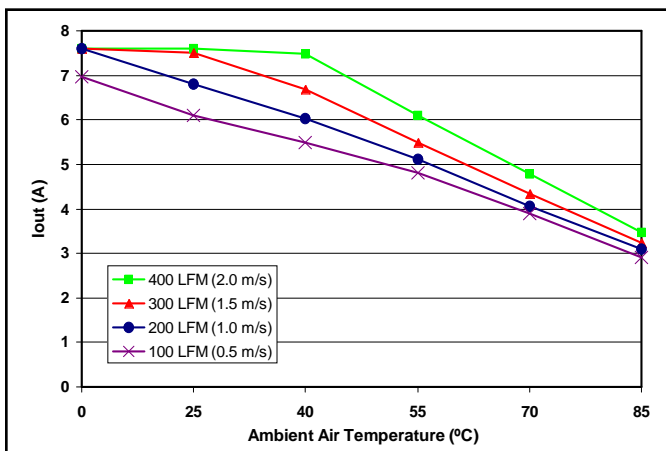

Figure 5: Maximum output power derating curves vs. ambient air temperature for a baseplated unit (full power at 100°C baseplate). Airflow rates of 100 LFM through 400 LFM with air flowing from input to output (nominal input voltage).

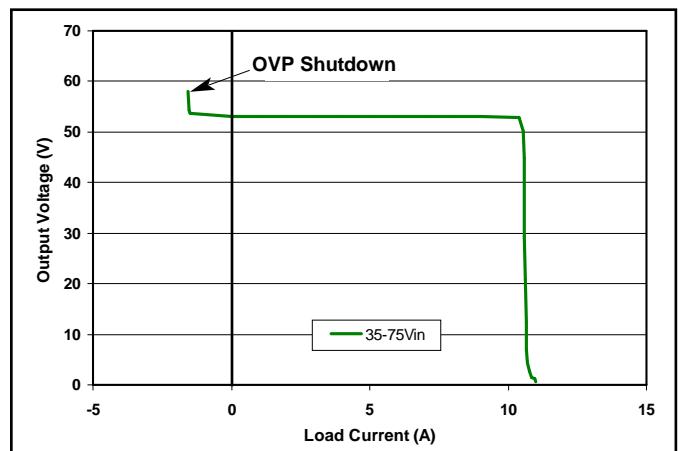

Figure 6: Output voltage vs. load current showing typical current limit curves and converter shutdown points.

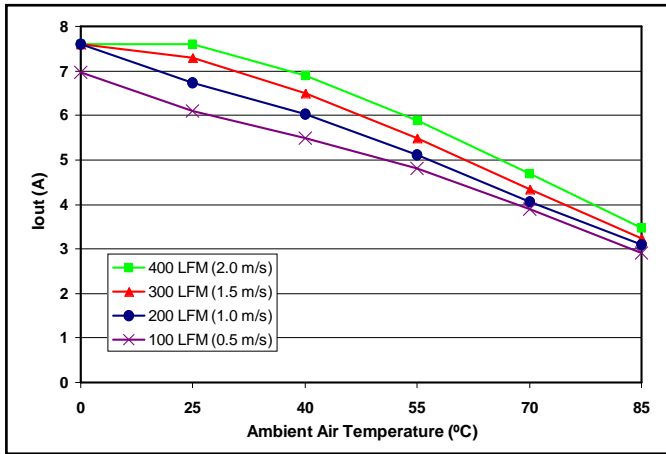

Figure 7: Maximum output power derating curves vs. ambient air temperature for an open frame unit. Airflow rates of 100 LFM through 400 LFM with air flowing from input to output (nominal input voltage).

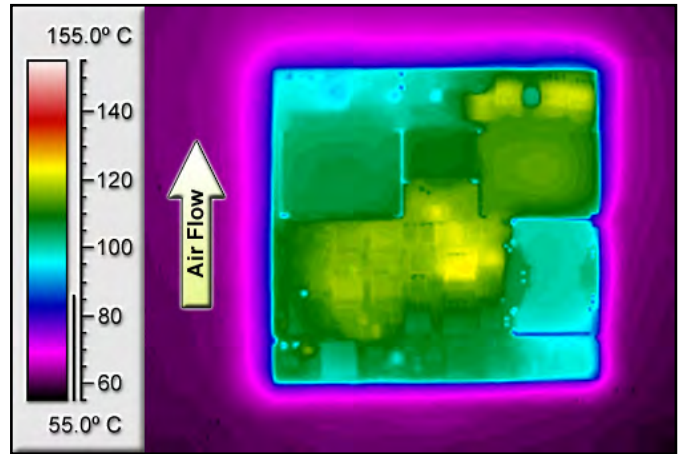

Figure 8: Thermal plot of converter at 5.1 amp load current (271W) with 55°C air flowing at the rate of 200 LFM. Air is flowing across the converter from input to output (nominal input voltage).

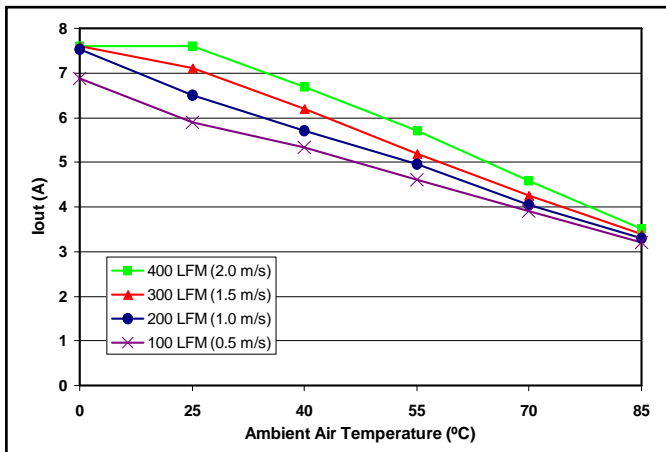

Figure 9: Maximum output power derating curves vs. ambient air temperature for an open frame unit. Airflow rates of 100 LFM through 400 LFM with air flowing from pin 1 to pin 4 (nominal input voltage).

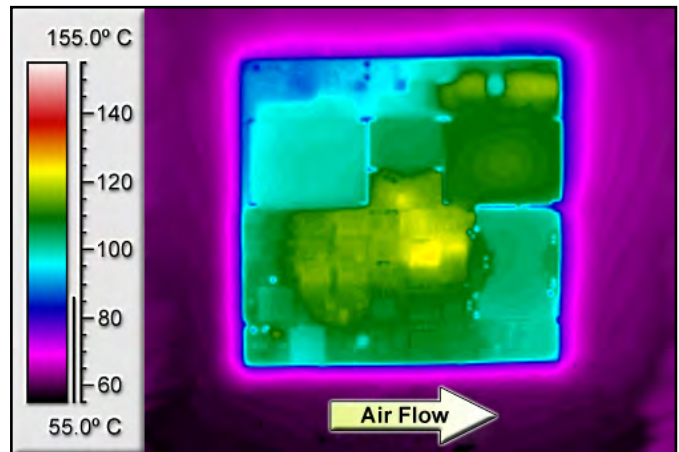

Figure 10: Thermal plot of converter at 4.95 amp load current (262W) with 55°C air flowing at the rate of 200 LFM. Air is flowing across the converter from pin 1 to pin 4 (nominal input voltage).

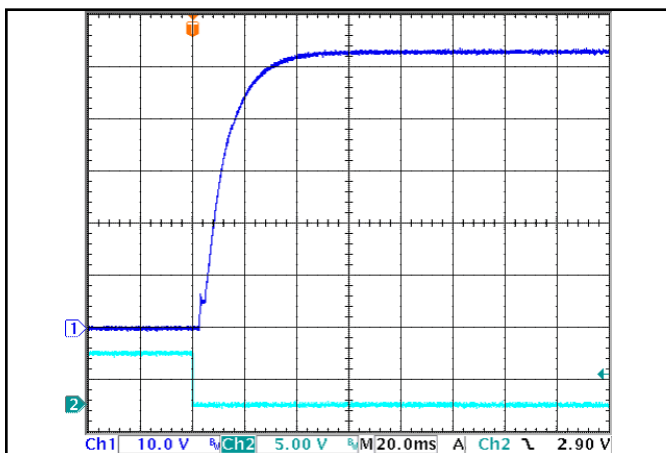

Figure 11: Turn-on transient at full load (resistive load) (20 ms/div). Input voltage pre-applied. Top Trace: Vout (10V/div). Bottom Trace: ON/OFF input (5V/div)

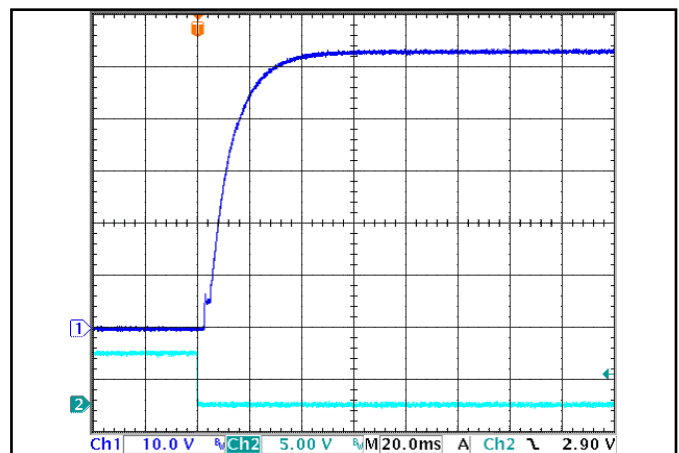

Figure 12: Turn-on transient at zero load (20 ms/div). Top Trace: Vout (10V/div) Bottom Trace: ON/OFF input (5V/div)

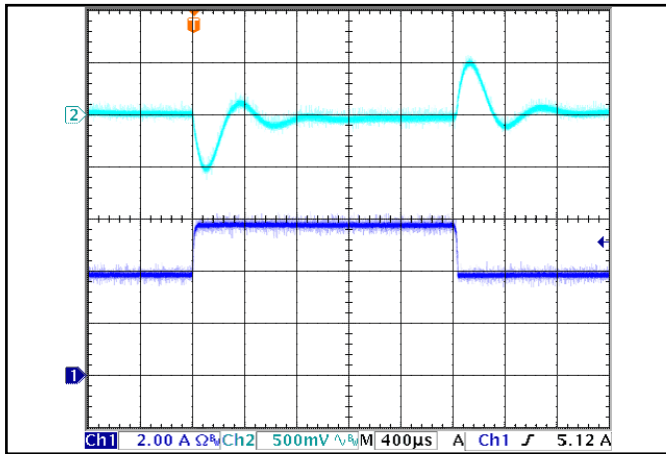

Figure 13: Output voltage response to step-change in load current (50%-75%-50% of $I_{out(max)}$; $dI/dt = 0.1A/\mu s$). Load cap: 200 μF , electrolytic output capacitance. Top trace: V_{out} (500mV/div), Bottom trace: I_{out} (2A/div).

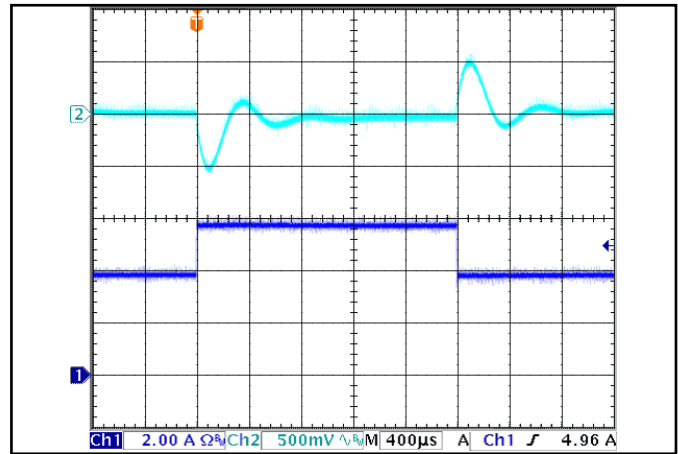

Figure 14: Output voltage response to step-change in load current (50%-75%-50% of $I_{out(max)}$; $dI/dt = 1A/\mu s$). Load cap: 330 μF , electrolytic output capacitance. Top trace: V_{out} (500mV/div), Bottom trace: I_{out} (2A/div).

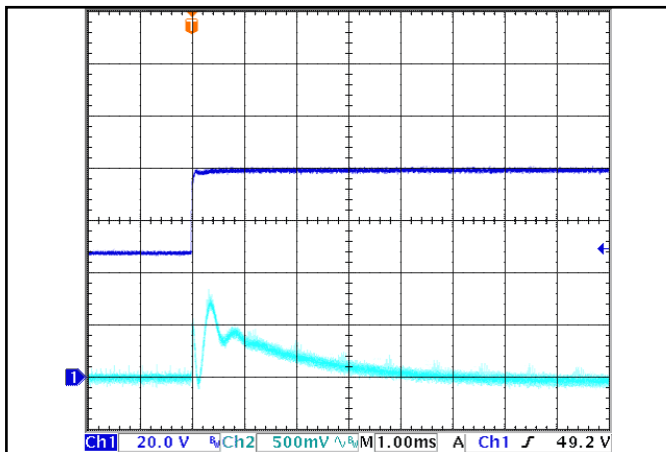

Figure 15: Output voltage response to step-change in input voltage (1000V/ms). Load cap: 200 μF , electrolytic output capacitance. Ch 1: V_{in} (20V/div), Ch 2: V_{out} (500mV/div).

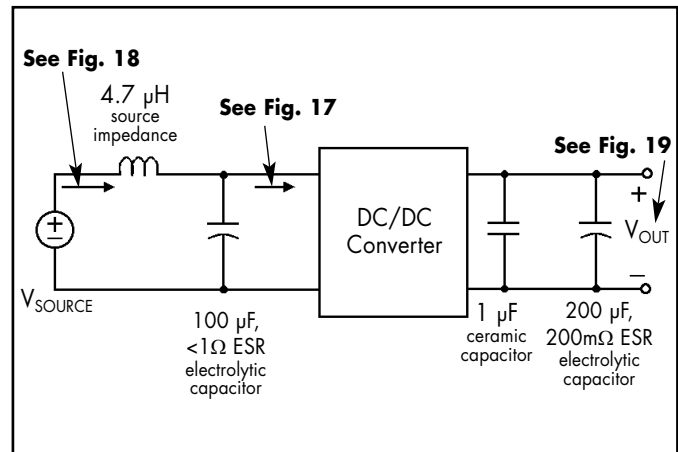

Figure 16: Test set-up diagram showing measurement points for Input Terminal Ripple Current (Figure 17), Input Reflected Ripple Current (Figure 18) and Output Voltage Ripple (Figure 19).

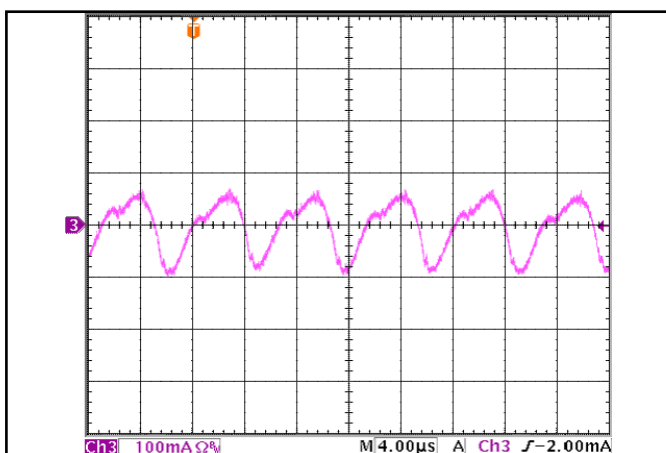

Figure 17: Input Terminal Ripple Current, i_c , at full rated output current and nominal input voltage with 4.7 μH source inductor and 100 μF electrolytic capacitor (100 mA/div). See Figure 16

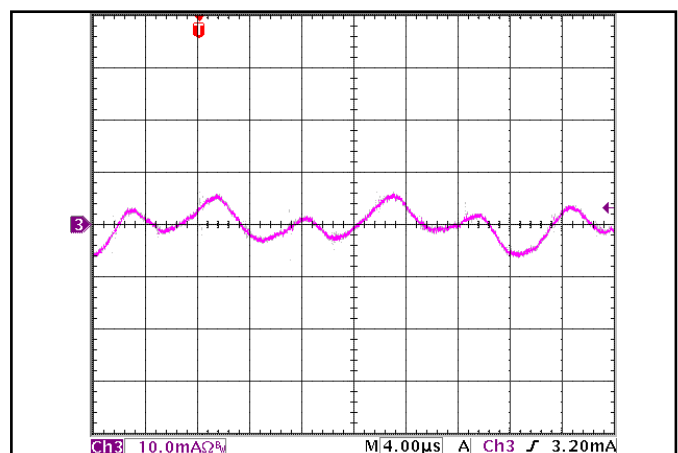

Figure 18: Input reflected ripple current, i_r , through a 4.7 μH source inductor at nominal input voltage and rated load current (10 mA/div). (See Figure 16)

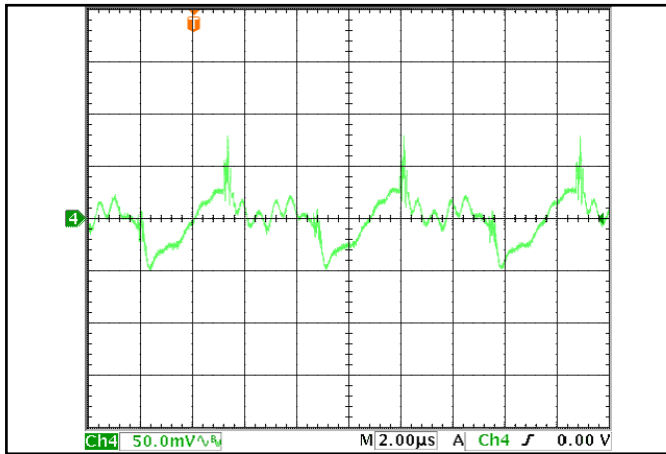

Figure 19: Output voltage ripple at nominal input voltage and rated load current (50 mV/div). Load capacitance: 1µF ceramic capacitor and 200µF tantalum capacitor. Bandwidth: 20 MHz. (See Figure 12)

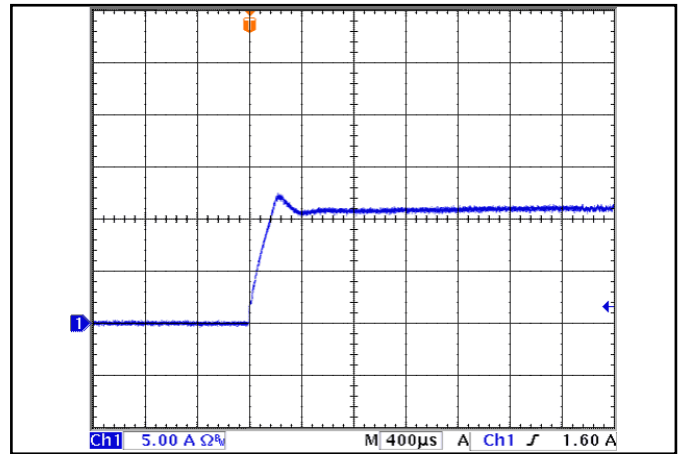

Figure 20: Load current (5A/div) as a function of time when the converter attempts to turn on into a 1 mΩ short circuit.

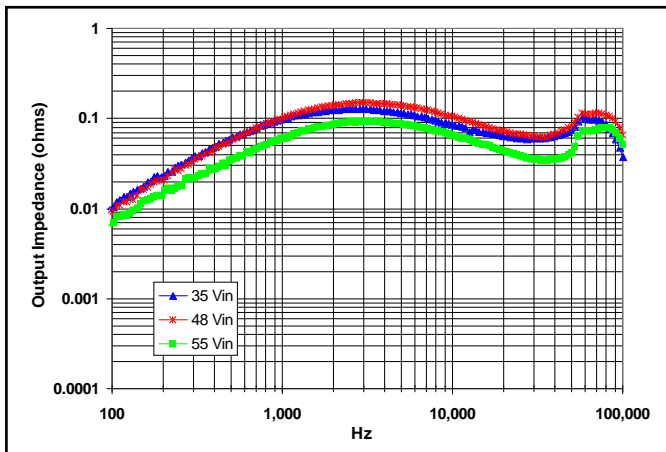

Figure 21: Magnitude of incremental output impedance ($Z_{out} = v_{out}/i_{out}$) for minimum, nominal, and maximum input voltage at full rated power.

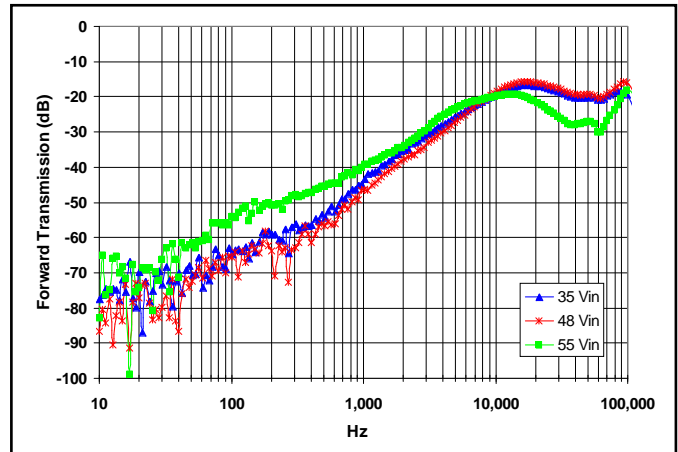

Figure 22: Magnitude of incremental forward transmission ($FT = v_{out}/v_{in}$) for minimum, nominal, and maximum input voltage at full rated power.

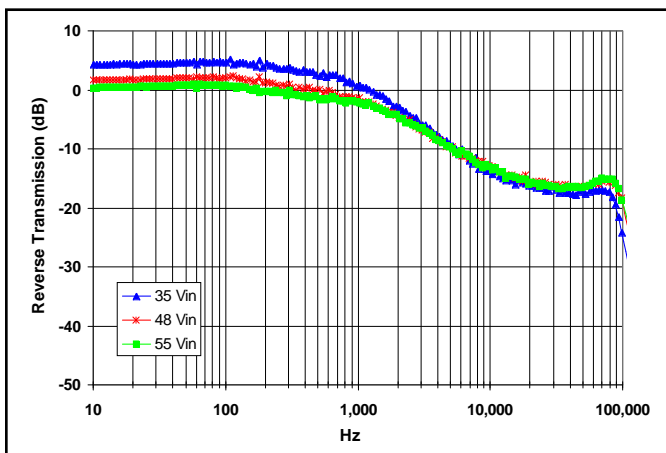

Figure 23: Magnitude of incremental reverse transmission ($RT = i_{in}/i_{out}$) for minimum, nominal, and maximum input voltage at full rated power.

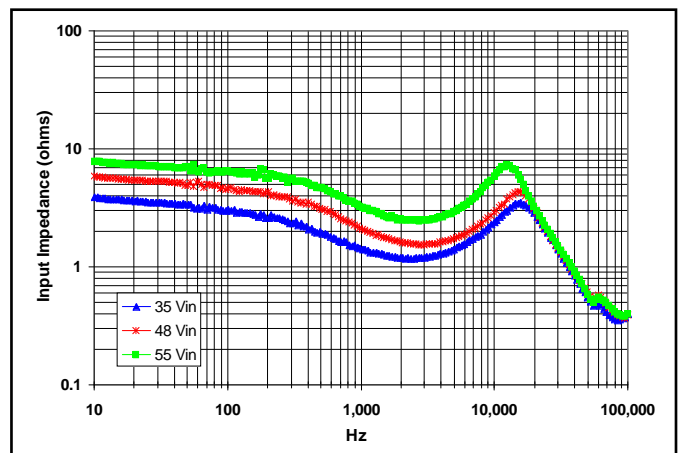

Figure 24: Magnitude of incremental input impedance ($Z_{in} = v_{in}/i_{in}$) for minimum, nominal, and maximum input voltage at full rated power.

BASIC OPERATION AND FEATURES

The PowerQor series converter uses a two-stage power conversion topology. The first stage is a buck-converter that keeps the output voltage constant over variations in line, load, and temperature. The second stage uses a transformer to provide the functions of input/output isolation and voltage step-down to achieve the low output voltage required.

Both the first stage and the second stage switch at a fixed frequency for predictable EMI performance. Rectification of the transformer's output is accomplished with synchronous rectifiers. These devices, which are MOSFETs with a very low on-state resistance, dissipate far less energy than Schottky diodes. This is the primary reason that the PowerQor converter has such high efficiency, even at very low output voltages and very high output currents.

The PowerQor series of half-brick and quarter-brick converters uses the industry standard footprint and pin-out configuration.

CONTROL FEATURES

REMOTE ON/OFF (Pin 2): The ON/OFF input, Pin 2, permits the user to control when the converter is on or off. This input is referenced to the return terminal of the input bus, Vin(-). There are two versions of the converter that differ by the sense of the logic used for the ON/OFF input.

In the positive logic version, the ON/OFF input is active high (meaning that a high turns the converter on). In the negative logic version, the ON/OFF signal is active low (meaning that a low turns the converter on). Figure A details five possible circuits for driving the ON/OFF pin.

REMOTE SENSE(+) (Pins 8 and 6): The SENSE(±) inputs correct for voltage drops along the conductors that connect the converter's output pins to the load.

Pin 8 should be connected to Vout(+) and Pin 6 should be connected to Vout(-) at the point on the board where regulation is desired. A remote connection at the load can adjust for a voltage drop only as large as that specified in this datasheet, that is

$$[V_{out(+)} - V_{out(-)}] - [V_{sense(+)} - V_{sense(-)}] \leq \text{Sense Range \%} \times V_{out}$$

Pins 8 and 6 must be connected for proper regulation of the output voltage. If these connections are not made, the converter will deliver an output voltage that is slightly higher than its specified value.

Note: the output over-voltage protection circuit senses the voltage across the output (pins 9 and 5) to determine when it should trigger, not the voltage across the converter's sense leads (pins 8 and 6). Therefore, the resistive drop on the board should be small enough so that output OVP does not trigger, even during load transients.

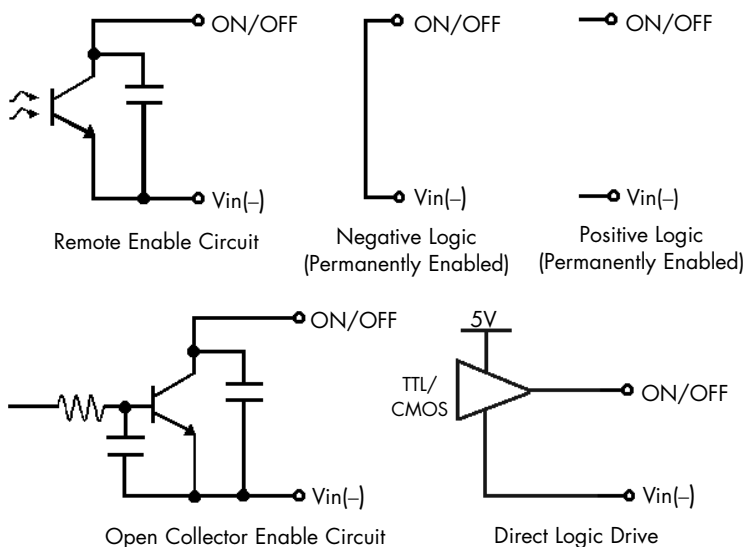

Figure A: Various circuits for driving the ON/OFF pin.

OUTPUT VOLTAGE TRIM (Pin 7): The TRIM input permits the user to adjust the output voltage across the sense leads up or down according to the trim range specifications.

To decrease the output voltage, the user should connect a resistor between Pin 7 and Pin 6 (SENSE(-) input). For a desired decrease of the nominal output voltage, the value of the resistor should be

$$R_{\text{trim-down}} = \left(\frac{100\%}{\Delta} \right) - 2 \text{ (k}\Omega\text{)}$$

where

$$\Delta\% = \left| \frac{V_{\text{nominal}} - V_{\text{desired}}}{V_{\text{nominal}}} \right| \times 100\%$$

To increase the output voltage, the user should connect a resistor between Pin 7 and Pin 8 (SENSE(+) input). For a desired increase of the nominal output voltage, the value of the resistor should be

$$R_{\text{trim-up}} = \frac{\left(\frac{V_{\text{nominal}}}{1.225} - 2 \right) \times V_{\text{DES}} + V_{\text{NOM}}}{V_{\text{DES}} - V_{\text{NOM}}} \text{ (k}\Omega\text{)}$$

Figure B graphs the relationship between the trim resistor value and R_{trim-up} and R_{trim-down}, showing the total range the output voltage can be trimmed up or down.

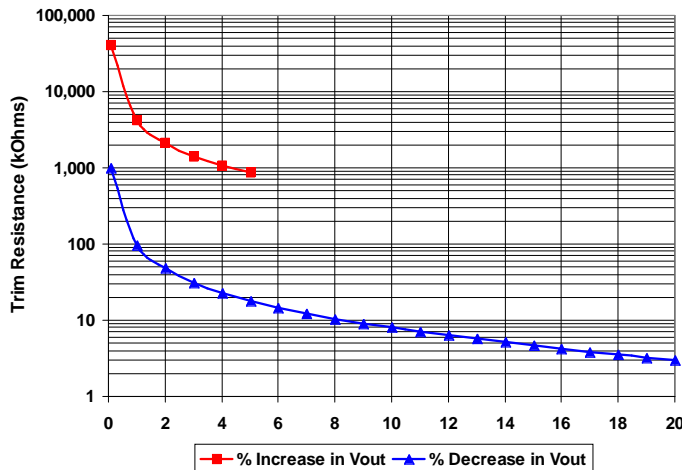

Figure B: Trim Graph for 53Vout module

Note: the TRIM feature does not affect the voltage at which the output over-voltage protection circuit is triggered. Trimming the output voltage too high may cause the over-voltage protection circuit to engage, particularly during transients.

It is not necessary for the user to add capacitance at the Trim pin. The node is internally bypassed to eliminate noise.

Total DC Variation of Vout: For the converter to meet its full specifications, the maximum variation of the DC value of Vout, due to both trimming and remote load voltage drops, should not be greater than that specified for the output voltage trim range.

PROTECTION FEATURES

Input Under-Voltage Lockout: The converter is designed to turn off when the input voltage is too low, helping avoid an input system instability problem, described in more detail in the application note titled "Input System Instability". The lockout circuitry is a comparator with DC hysteresis. When the input voltage is rising, it must exceed the typical Turn-On Voltage Threshold value (listed on the specification page) before the converter will turn on. Once the converter is on, the input voltage must fall below the typical Turn-Off Voltage Threshold value before the converter will turn off.

Output Current Limit: If the load current is increased to the current limit threshold, the current will be limited at that value, and the output voltage will decrease as the load resistance is lowered. When the load current is decreased below the current limit point, the voltage will recover to the normal, regulated level.

Note: If the unit is held in overcurrent and the load is suddenly reduced to zero, an output voltage overshoot can occur and possibly trip the overvoltage protection.

Output Over-Voltage Protection: If the voltage across the output pins exceeds the Output Over-Voltage Protection threshold, the converter will immediately shut down and latch off. To reset this latched fault condition, either the ON/OFF pin must be toggled from on to off and back on again or the input power must be removed and re-applied.

Over-Temperature Shutdown: A temperature sensor on the converter senses the average temperature of the module. The thermal shutdown circuit is designed to turn the converter off when the temperature at the sensed location reaches the Over-Temperature Shutdown value. It will allow the converter to turn on again when the temperature of the sensed location falls by the amount of the Over-Temperature Shutdown Restart Hysteresis value.

APPLICATION CONSIDERATIONS

Input System Instability: This condition can occur because any DC/DC converter appears incrementally as a negative resistance load. A detailed application note titled "Input System Instability" is available on the SynQor website which provides an understanding of why this instability arises, and shows the preferred solution for correcting it.

Application Circuits: Figure C provides a typical circuit diagram which details the input filtering and voltage trimming.

Input Filtering and External Capacitance: Figure D provides a diagram showing the internal input filter components. This filter dramatically reduces input terminal ripple current, which otherwise could exceed the rating of an external electrolytic input capacitor. The recommended external input capacitance is specified in the "Input Characteristics" section. More detailed information is available in the application note titled "EMI Characteristics" on the SynQor website.

Startup Inhibit Period: The Startup Inhibit Period ensures that the converter will remain off for approximately 6ms when it is shut down for any reason. In all, there are three ways that the converter can be shut down, initiating a Startup Inhibit Period:

- Input Under-Voltage Lockout
- Over Temperature Shutdown
- Turned off by the ON/OFF input

Figure E shows three turn-on scenarios, where a Startup Inhibit Period is initiated at t_0 , t_1 , and t_2 :

Before time t_0 , when the input voltage is below the UVL threshold, the unit is disabled by the Input Under-Voltage Lockout feature. When the input voltage rises above the UVL threshold, the Input Under-Voltage Lockout is released, and a Startup Inhibit Period is initiated. At the end of this delay, the ON/OFF pin is evaluated, and since it is active, the unit turns on.

At time t_1 , the unit is disabled by the ON/OFF pin, and it cannot be enabled again until the Startup Inhibit Period has elapsed.

If the input voltage quickly rises over UVLO at t_3 , the output start-up time is 12ms.

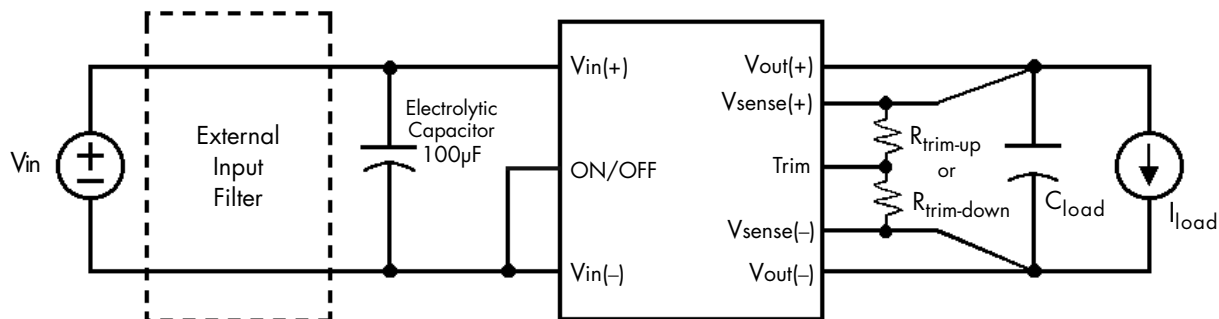

Figure C: Typical application circuit (negative logic unit, permanently enabled).

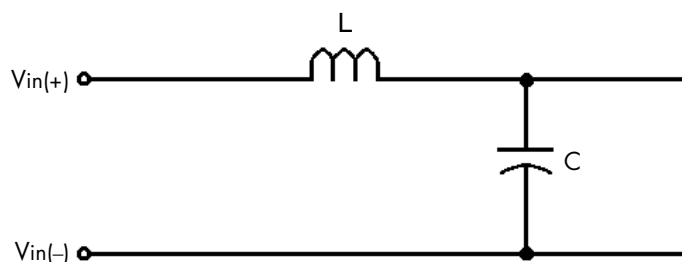

Figure D: Internal Input Filter Diagram (component values listed on page 4).

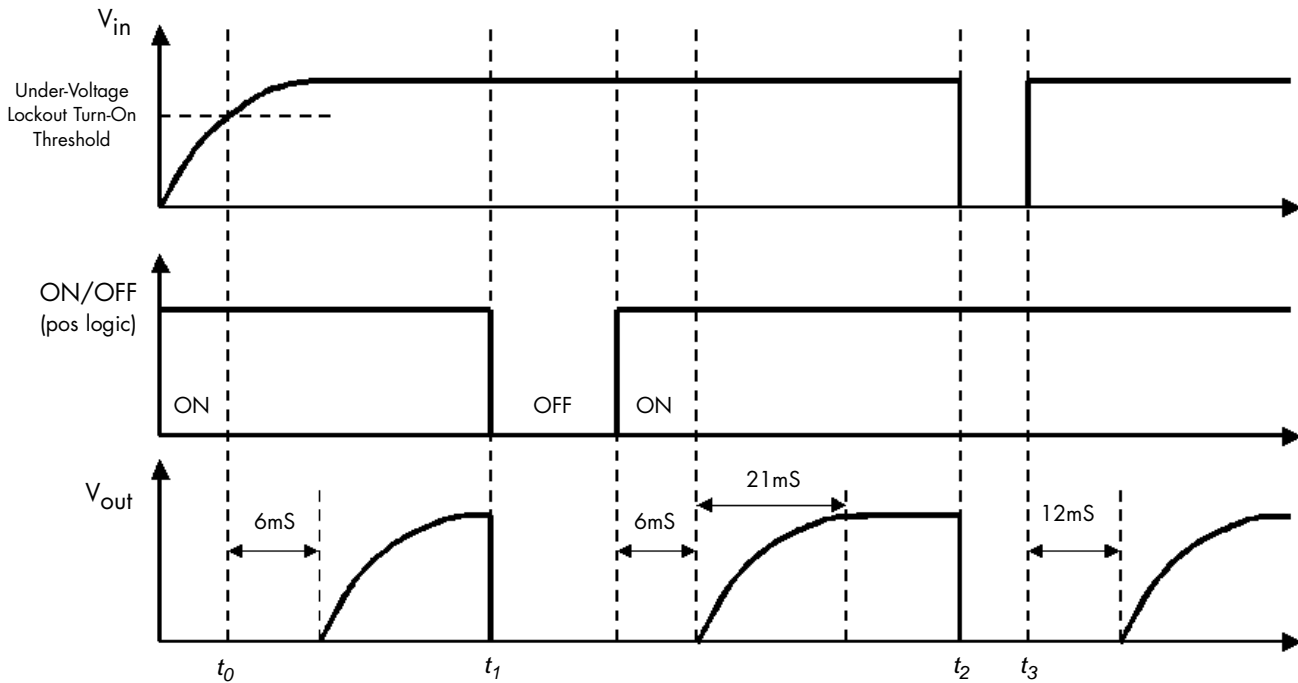

Figure E: Startup Inhibit Period (turn-on time not to scale)

RoHS Compliance: The EU led RoHS (Restriction of Hazardous Substances) Directive bans the use of Lead, Cadmium, Hexavalent Chromium, Mercury, Polybrominated Biphenyls (PBB), and Polybrominated Diphenyl Ether (PBDE) in Electrical and Electronic Equipment. This SynQor product is available as 5/6 RoHS compliant (product with lead) or 6/6 RoHS compliant. For more information please refer to SynQor's RoHS addendum available at our [RoHS Compliance / Lead Free Initiative](#) web page or e-mail us at rohs@synqor.com.



Technical Specification

Input: 38-55 V
Output: 53 V
Current: 7.6 A
Package: Half-brick

PART NUMBERING SYSTEM

The part numbering system for SynQor's PowerQor DC/DC converters follows the format shown in the example below.

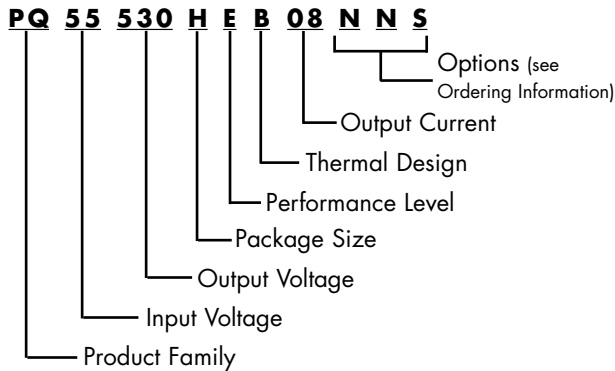

The first 12 characters comprise the base part number and the last 3 characters indicate available options. Although there are no default values for enable logic and pin length, the most common options are negative logic and 0.145" pins. These part numbers are more likely to be readily available in stock for evaluation and prototype quantities. A "-G" suffix indicates 6/6 RoHS compliance.

Application Notes

A variety of application notes and technical white papers can be downloaded in pdf format from our [website](#).

ORDERING INFORMATION

The tables below show the valid model numbers and ordering options for converters in this product family. When ordering SynQor converters, please ensure that you use the complete 15 character part number consisting of the 12 character base part number and the additional 3 characters for options. To order 6/6 RoHS compliant product please add a "-G" suffix.

Model Number	Input Voltage	Output Voltage	Max Output Current
PQ55530HEA08 xyz	38 - 55 V	53.0 V	7.6 A
PQ55530HEB08 xyz	38 - 55 V	53.0 V	7.6 A

The following option choices must be included in place of the x y z spaces in the model numbers listed above.

Options Description: x y z		
Enable Logic	Pin Length	Feature Set
P - Positive N - Negative	K - 0.110" N - 0.145" R - 0.180" Y - 0.250"	S - Standard A - Tight Accuracy

Contact SynQor for further information:

Phone: 978-849-0600
Toll Free: 888-567-9596
Fax: 978-849-0602
E-mail: power@synqor.com
Web: www.synqor.com
Address: 155 Swanson Road
 Boxborough, MA 01719
 USA

Warranty

SynQor offers a three (3) year limited warranty. Complete warranty information is listed on our [website](#) or is available upon request from SynQor.

Information furnished by SynQor is believed to be accurate and reliable. However, no responsibility is assumed by SynQor for its use, nor for any infringements of patents or other rights of third parties which may result from its use. No license is granted by implication or otherwise under any patent or patent rights of SynQor.