



**NON BASE LEAD
OPTICALLY COUPLED ISOLATOR
PHOTODARLINGTON OUTPUT**

APPROVALS

- UL recognised, File No. E91231

'X' SPECIFICATION APPROVALS

- VDE 0884 in 3 available lead form :-
- STD
- G form
- SMD approved to CECC 00802

DESCRIPTION

The MOC8020, MOC8021 series of optically coupled isolators consist of an infrared light emitting diode and NPN silicon photodarlington in a standard 6pin dual in line plastic package with the base pin unconnected.

FEATURES

- Options :-
10mm lead spread - add G after part no.
Surface mount - add SM after part no.
Tape&reel - add SMT&R after part no.
- High Current Transfer Ratio (500% min)
- $BV_{ceo} 35V$
- High Isolation Voltage ($5.3kV_{RMS}, 7.5kV_{PK}$)
- Base pin unconnected for improved noise immunity in high EMI environment
- High sensitivity to low input drive current
- Custom electrical selections available

APPLICATIONS

- Computer terminals
- Industrial systems controllers
- Measuring instruments
- Signal transmission between systems of different potentials and impedances

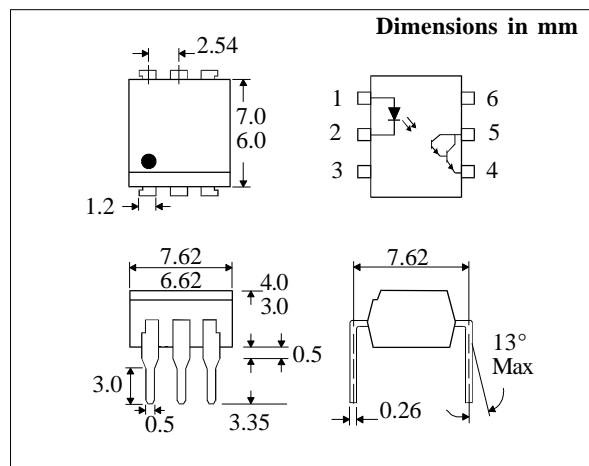
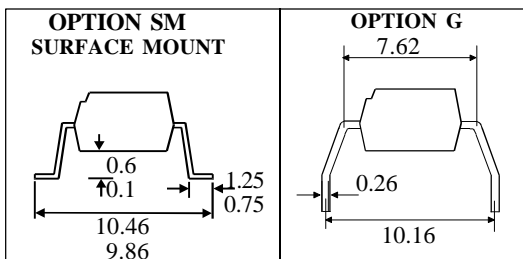

**ABSOLUTE MAXIMUM RATINGS
(25°C unless otherwise specified)**

Storage Temperature _____ -40°C to +125°C
Operating Temperature _____ -25°C to +100°C
Lead Soldering Temperature
(1/16 inch (1.6mm) from case for 10 secs) 260°C

INPUT DIODE

Forward Current _____ 50mA
Reverse Voltage _____ 6V
Power Dissipation _____ 70mW

OUTPUT TRANSISTOR

Collector-emitter Voltage BV_{CEO} _____ 35V
Emitter-collector Voltage BV_{ECO} _____ 6V
Power Dissipation _____ 150mW

POWER DISSIPATION

Total Power Dissipation _____ 170mW
(derate linearly 3.3mW/°C above 25°C)

ISOCOM COMPONENTS LTD
Unit 25B, Park View Road West,
Park View Industrial Estate, Brenda Road
Hartlepool, Cleveland, TS25 1YD
Tel: (01429) 863609 Fax :(01429) 863581

ELECTRICAL CHARACTERISTICS ($T_A = 25^\circ\text{C}$ Unless otherwise noted)

PARAMETER		MIN	TYP	MAX	UNITS	TEST CONDITION
Input	Forward Voltage (V_F)		1.2	1.4	V	$I_F = 10\text{mA}$
	Reverse Current (I_R)			10	μA	$V_R = 4\text{V}$
Output	Collector-emitter Breakdown (BV_{CEO})	35			V	$I_C = 0.1\text{mA}$
	Emitter-collector Breakdown (BV_{ECO})	6			V	$I_E = 10\mu\text{A}$
	Collector-emitter Dark Current (I_{CEO})			10^{-6}	A	$V_{CE} = 10\text{V}$
Coupled	Output Collector Current (I_C)(Note 2) MOC8020 MOC8021	50 100			mA mA	$10\text{mA } I_F, 5\text{V } V_{CE}$ $10\text{mA } I_F, 5\text{V } V_{CE}$
	Input to Output Isolation Voltage V_{ISO}	5300 7500			V_{RMS} V_{PK}	(note 1) (note 1)
	Input-output Isolation Resistance R_{ISO}		10^{11}		Ω	$V_{IO} = 500\text{V}$ (note 1)
	Response Time (Rise), t_r Response Time (Fall), t_f		60 53		μs μs	$V_{CE} = 2\text{V}, I_C = 10\text{mA},$ $R_L = 100\Omega$, fig.1

Note 1 Measured with input leads shorted together and output leads shorted together.
 Note 2 Special Selections are available on request. Please consult the factory.

FIGURE 1

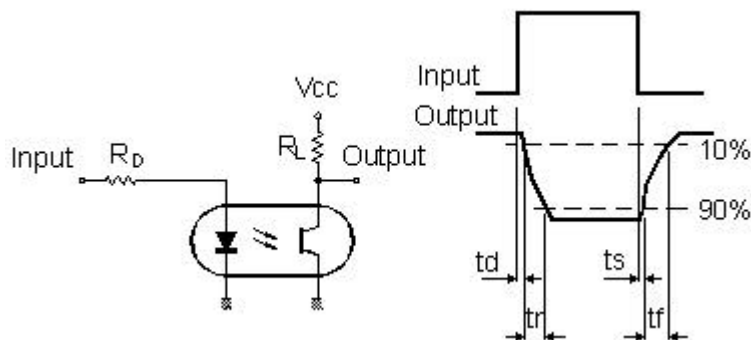

Fig.1 Forward Current vs. Ambient Temperature

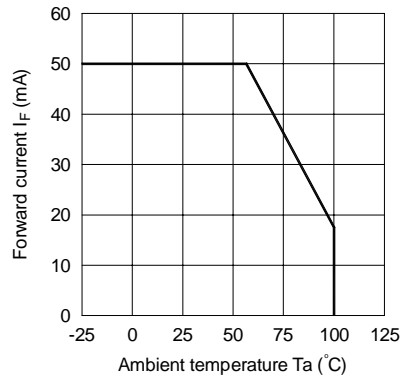

Fig.2 Collector Power Dissipation vs. Ambient Temperature

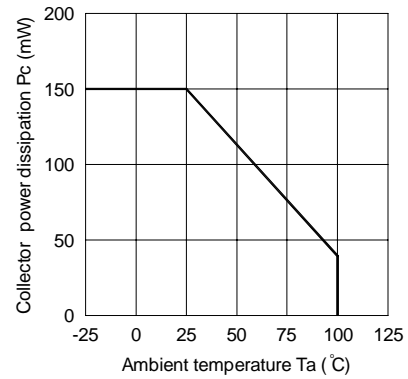

Fig.3 Current Transfer Ratio vs. Forward Current

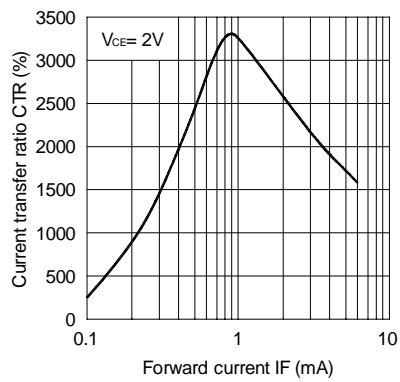

Fig.4 Forward Current vs. Forward Voltage

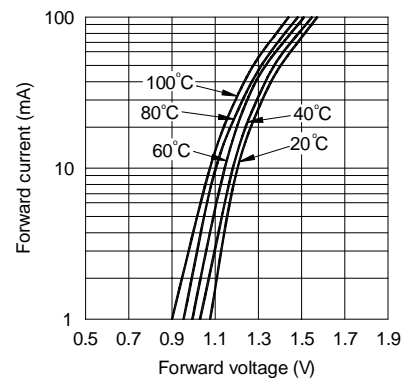

Fig.5 Collector Current vs. Collector-emitter Voltage

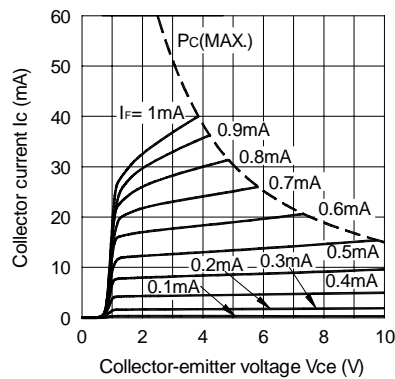

Fig.6 Collector Current vs. Collector-emitter Voltage

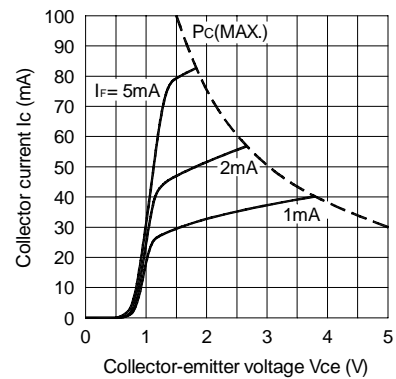

Fig.7 Relative Current Transfer Ratio vs. Ambient Temperature

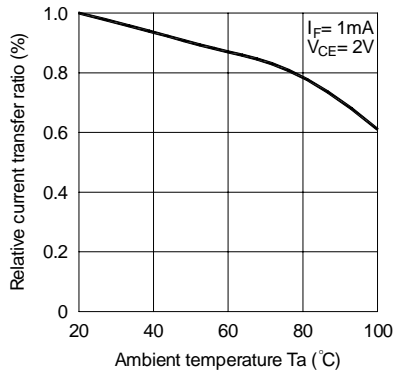

Fig.8 Collector-emitter Saturation Voltage vs. Ambient Temperature

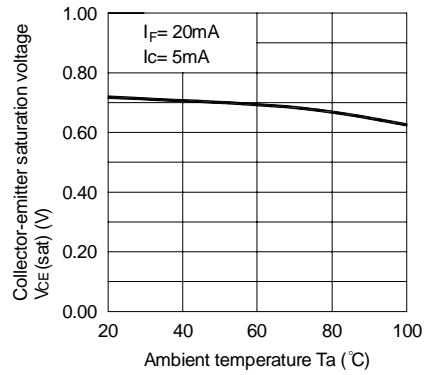

Fig.9 Collector Dark Current vs. Ambient Temperature

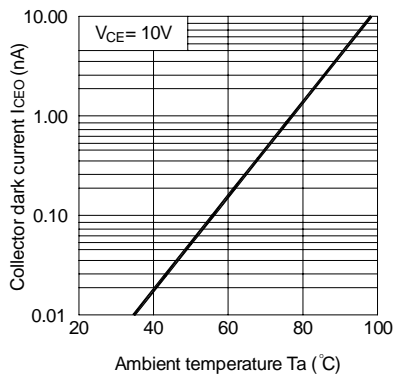

Fig.10 Response Time vs. Load Resistance

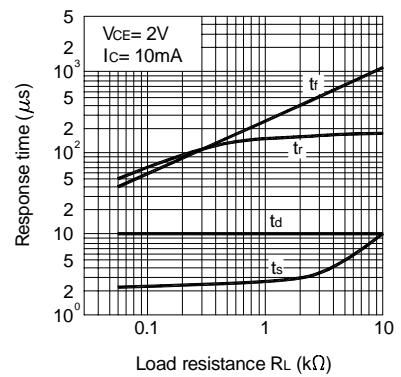
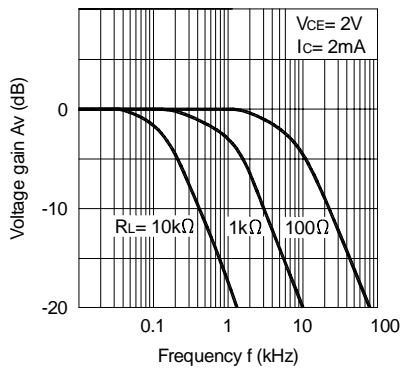
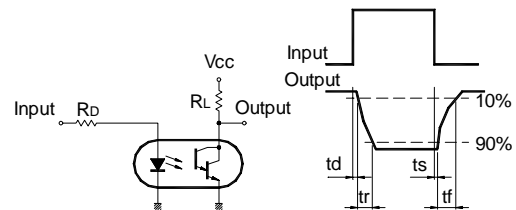

Fig.11 Frequency Response



Test Circuit for Response Time



Test Circuit for Frequency Response

