

Silicon NPN Power Transistors

2SC3688

DESCRIPTION

- With TO-3PN package
- High breakdown voltage
- High speed

APPLICATIONS

- Ultrahigh-definition color display horizontal deflection output applications

PINNING

PIN	DESCRIPTION
1	Base
2	Collector;connected to mounting base
3	Emitter

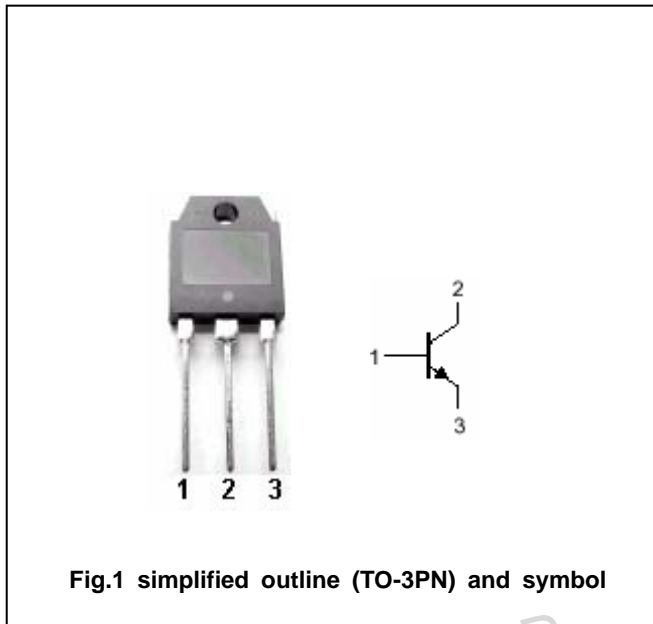

Fig.1 simplified outline (TO-3PN) and symbol

Absolute maximum ratings(Ta=25)

SYMBOL	PARAMETER	CONDITIONS	VALUE	UNIT
V_{CBO}	Collector-base voltage	Open emitter	1500	V
V_{CEO}	Collector-emitter voltage	Open base	800	V
V_{EBO}	Emitter-base voltage	Open collector	6	V
I_C	Collector current (DC)		10	A
I_{CM}	Collector current-peak		25	A
P_C	Collector power dissipation	$T_C=25$	150	W
T_j	Junction temperature		150	
T_{stg}	Storage temperature		-55~150	

Silicon NPN Power Transistors

2SC3688

CHARACTERISTICS

T_j=25 unless otherwise specified

SYMBOL	PARAMETER	CONDITIONS	MIN	TYP.	MAX	UNIT
V _{CEQ(SUS)}	Collector-emitter sustaining voltage	I _C =0.1A ; I _B =0A	800			V
V _{CEsat}	Collector-emitter saturation voltage	I _C =8A ; I _B =2.0A			5.0	V
V _{BEsat}	Base-emitter saturation voltage	I _C =8A ; I _B =2.0A			1.5	V
I _{CES}	Collector cut-off current	V _{CE} =1500V; R _{BE} =0V			1.0	mA
I _{EBO}	Emitter cut-off current	V _{EB} =4V; I _C =0A			1.0	mA
h _{FE}	DC current gain	I _C =1A ; V _{CE} =5V	8			

Switching times

t _s	Storage time	I _C =6.0A I _{B1} =1.2A; I _{B2} =-2.4A V _{CC} =200V			3.0	μs
t _f	Fall time				0.2	μs

Silicon NPN Power Transistors

2SC3688

PACKAGE OUTLINE

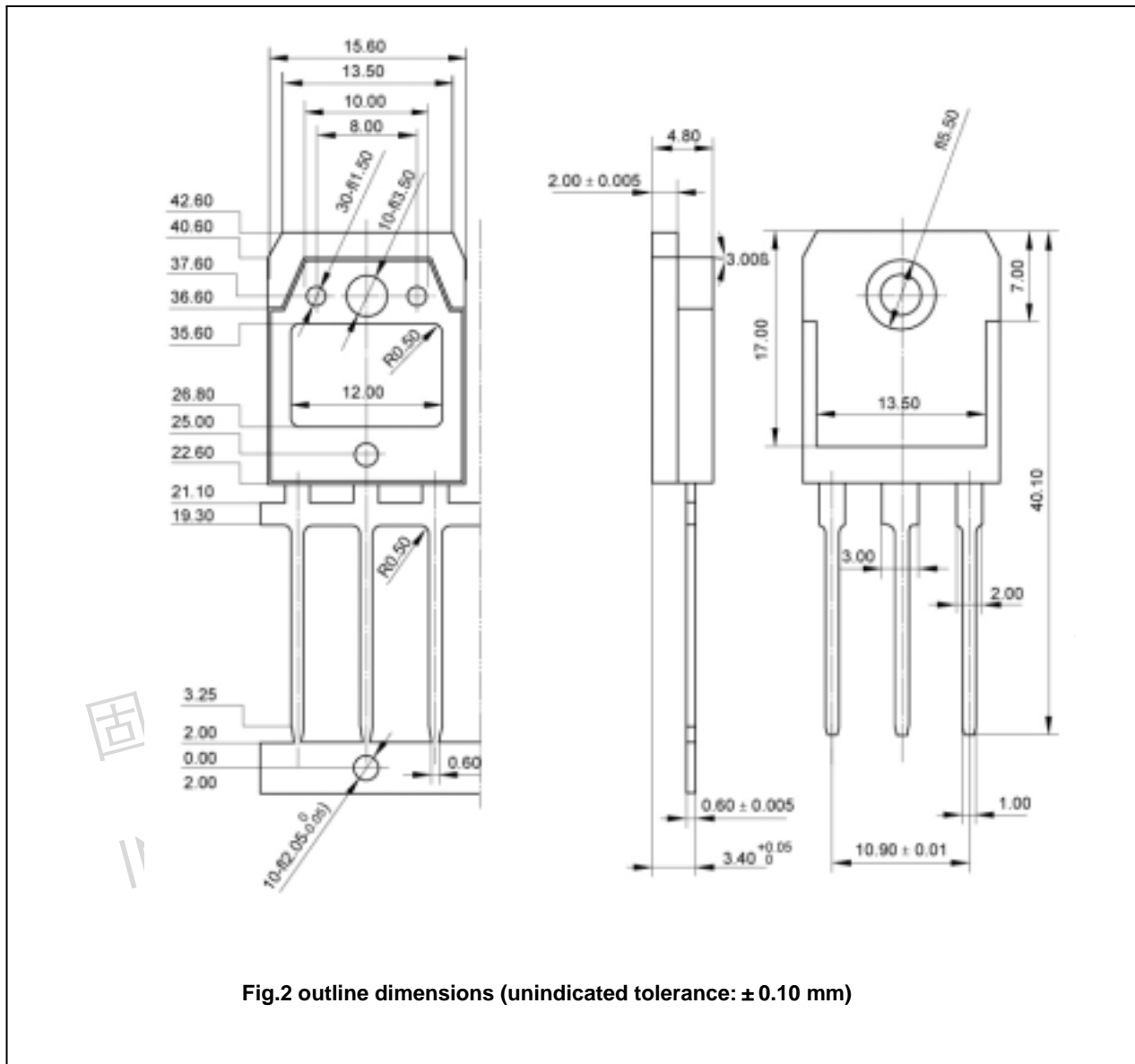

Fig.2 outline dimensions (unindicated tolerance: ± 0.10 mm)

Silicon NPN Power Transistors

2SC3688

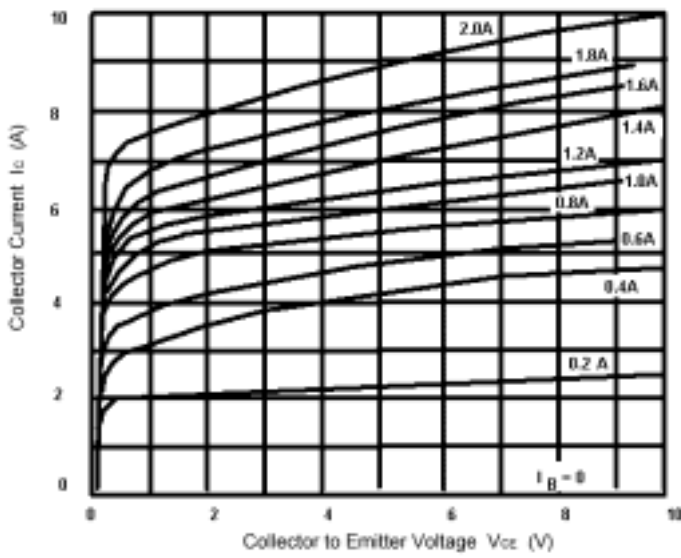

Fig.3 Static Characteristic

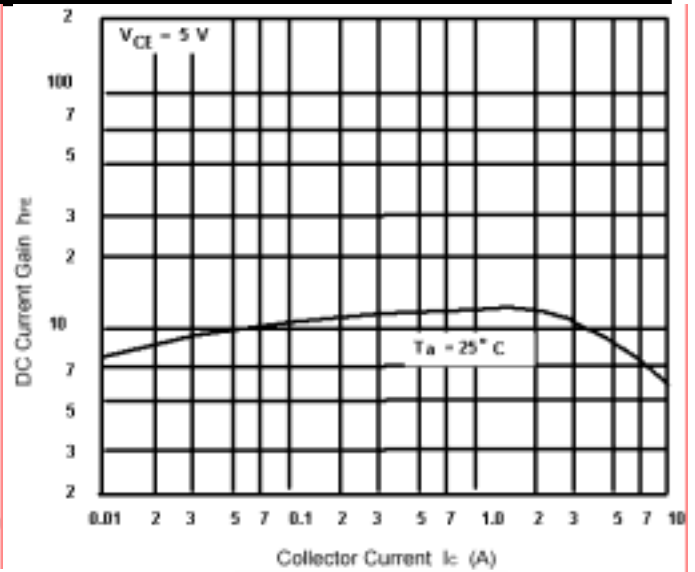

Fig.4 DC current Gain

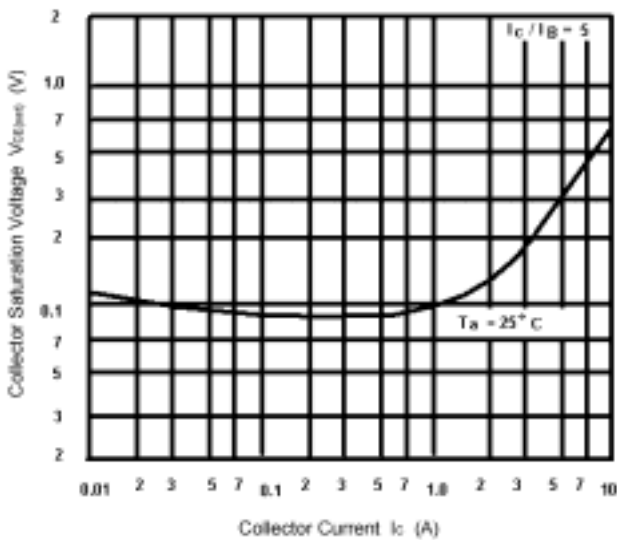

Fig.5 Collector-Emitter Saturation Voltage

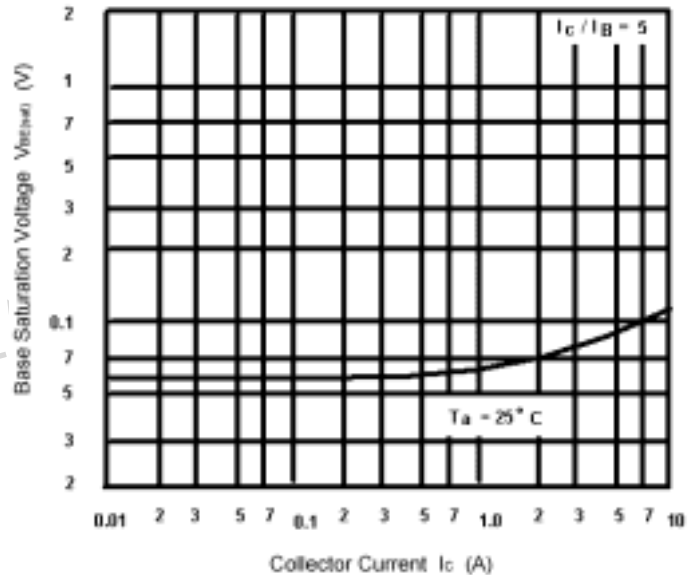

Fig.6 Base-Emitter Saturation Voltage

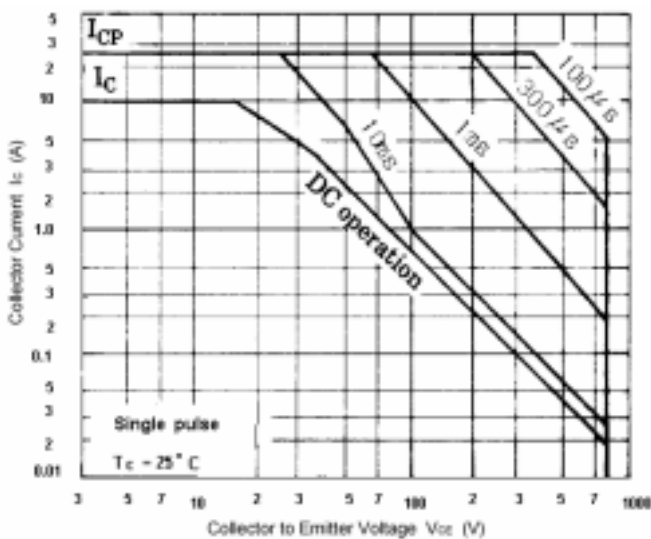

Fig.7 Safe Operating Area