

RoHS Compliant Product

## Description

The SSD40N03 provide the designer with the best combination of fast switching, ruggedized device design, low on-resistance and cost-effectiveness.

The TO-252 is universally preferred for all commercial-industrial surface mount applications and suited for low voltage applications such as DC/DC converters.

## Features

- \* Repetitive Avalanche Rated
- \* Dynamic dv/dt Rating
- \* Simple Drive Requirement
- \* Fast Switching

TO-252

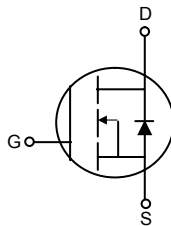
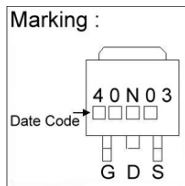
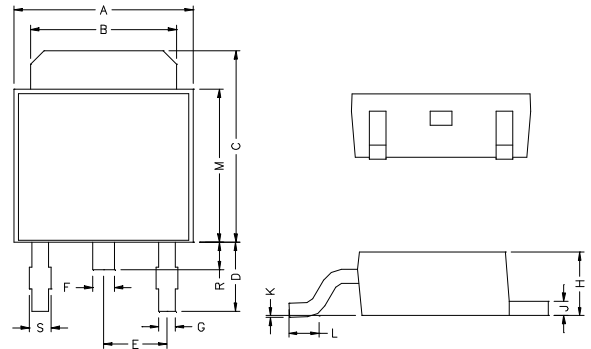

REF.	Millimeter		REF.	Millimeter	
	Min.	Max.		Min.	Max.
A	6.40	6.80	G	0.50	0.70
B	5.20	5.50	H	2.20	2.40
C	6.80	7.20	J	0.45	0.55
D	2.20	2.80	K	0	0.15
E	2.30 REF.		L	0.90	1.50
F	0.70	0.90	M	5.40	5.80
S	0.60	0.90	R	0.80	1.20

## Absolute Maximum Ratings

Parameter	Symbol	Ratings	Unit
Drain-Source Voltage	V <sub>DS</sub>	30	V
Gate-Source Voltage	V <sub>GS</sub>	±20	V
Continuous Drain Current, V <sub>GS</sub> @10V	I <sub>D</sub> @T <sub>C</sub> =25°C	36	A
Continuous Drain Current, V <sub>GS</sub> @10V	I <sub>D</sub> @T <sub>C</sub> =100°C	25	A
Pulsed Drain Current <sup>1</sup>	I <sub>DM</sub>	150	A
Total Power Dissipation	P <sub>D</sub> @T <sub>C</sub> =25°C	50	W
Linear Derating Factor		0.4	W/°C
Operating Junction and Storage Temperature Range	T <sub>j</sub> , T <sub>stg</sub>	-55~+150	°C

## Thermal Data

Parameter	Symbol	Ratings	Unit
Thermal Resistance Junction-case	R <sub>thj-c</sub>	2.5	°C/W
Thermal Resistance Junction-ambient	R <sub>thj-a</sub>	110	°C/W

## Electrical Characteristics( T<sub>j</sub>=25°C Unless otherwise specified)

Parameter	Symbol	Min.	Typ.	Max.	Unit	Test Condition
Drain-Source Breakdown Voltage	BV <sub>DSS</sub>	30	-	-	V	V <sub>GS</sub> =0V, I <sub>D</sub> =250uA
Breakdown Voltage Temp. Coefficient	ΔBV <sub>DSS</sub> /ΔT <sub>j</sub>	-	0.037	-	V/°C	Reference to 25°C, I <sub>D</sub> =1mA
Gate Threshold Voltage	V <sub>GS(th)</sub>	1.0	-	3.0	V	V <sub>DS</sub> =V <sub>GS</sub> , I <sub>D</sub> =250uA
Gate-Source Leakage Current	I <sub>GSS</sub>	-	-	±100	nA	V <sub>GS</sub> =±20V
Drain-Source Leakage Current (T <sub>j</sub> =25°C)	I <sub>DSS</sub>	-	-	25	uA	V <sub>DS</sub> =30V, V <sub>GS</sub> =0
Drain-Source Leakage Current(T <sub>j</sub> =150°C)		-	-	250	uA	V <sub>DS</sub> =24V, V <sub>GS</sub> =0
Static Drain-Source On-Resistance	R <sub>DS(ON)</sub>	-	18	21	mΩ	V <sub>GS</sub> =10V, I <sub>D</sub> =18A
		-	24	30		V <sub>GS</sub> =4.5V, I <sub>D</sub> =14A
Total Gate Charge <sup>2</sup>	Q <sub>g</sub>	-	17	-	nC	I <sub>D</sub> =18A V <sub>DS</sub> =24V V <sub>GS</sub> =5V
Gate-Source Charge	Q <sub>gs</sub>	-	3	-		
Gate-Drain ("Miller") Charge	Q <sub>gd</sub>	-	10	-		
Turn-on Delay Time <sup>2</sup>	T <sub>d(ON)</sub>	-	7.2	-	nS	V <sub>DD</sub> =15V I <sub>D</sub> =18A V <sub>GS</sub> =10V R <sub>G</sub> =3.3Ω R <sub>D</sub> =0.83Ω
Rise Time	T <sub>r</sub>	-	60	-		
Turn-off Delay Time	T <sub>d(off)</sub>	-	22.5	-		
Fall Time	T <sub>f</sub>	-	10	-		
Input Capacitance	C <sub>iss</sub>	-	800	-	pF	V <sub>GS</sub> =0V V <sub>DS</sub> =25V f=1.0MHz
Output Capacitance	C <sub>oss</sub>	-	380	-		
Reverse Transfer Capacitance	C <sub>rss</sub>	-	133	-		
Forward Transconductance	G <sub>fs</sub>	-	26	-	S	V <sub>DS</sub> =10V, I <sub>D</sub> =18A

## Source-Drain Diode

Parameter	Symbol	Min.	Typ.	Max.	Unit	Test Condition
Forward On Voltage <sup>2</sup>	V <sub>SD</sub>	-	-	1.3	V	I <sub>S</sub> =36 A, V <sub>GS</sub> =0V, T <sub>j</sub> =25°C
Continuous Source Current(Body Diode)	I <sub>S</sub>	-	-	36	A	V <sub>D</sub> =V <sub>G</sub> =0V, V <sub>S</sub> =1.3 V
Pulsed Source Current(Body Diode) <sup>1</sup>	I <sub>SM</sub>	-	-	150	A	

Notes: 1.Pulse width limited by safe operating area.

2.Pulse width ≤300us, dutycycle≤2%.

### Characteristics Curve

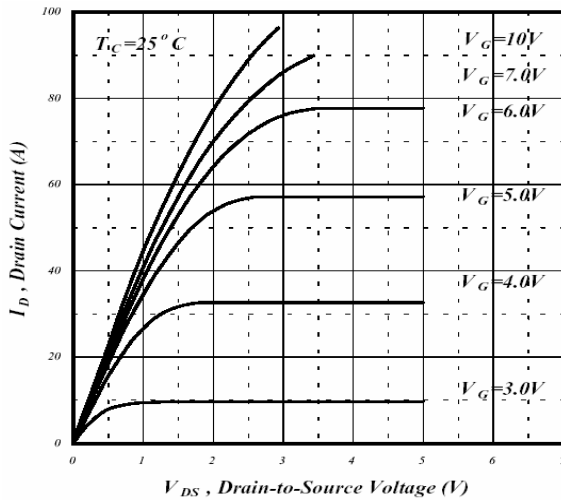

Fig 1. Typical Output Characteristics

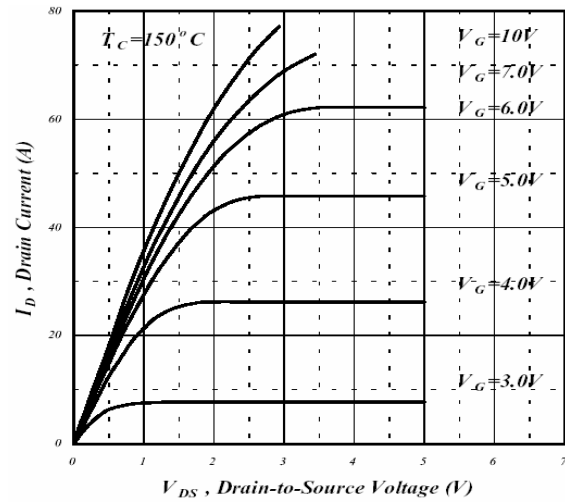

Fig 2. Typical Output Characteristics

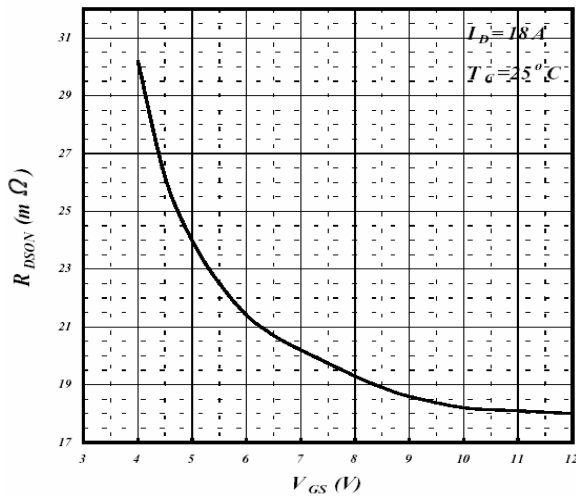

Fig 3. On-Resistance v.s. Gate Voltage

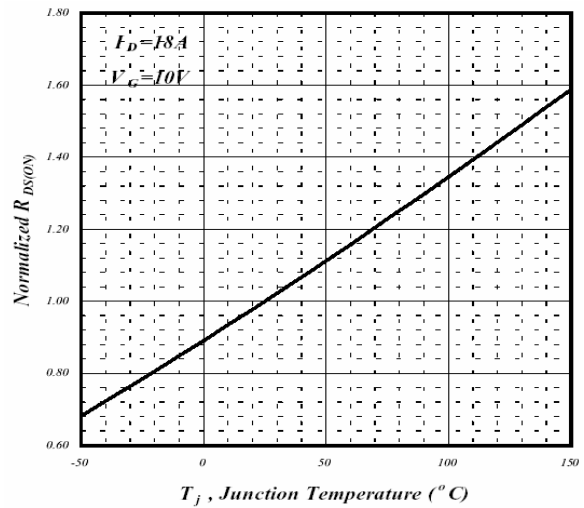

Fig 4. Normalized On-Resistance v.s. Junction Temperature

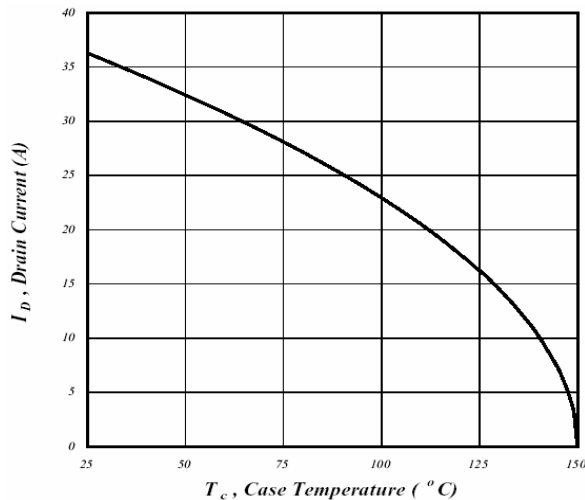

Fig 5. Maximum Drain Current v.s. Case Temperature

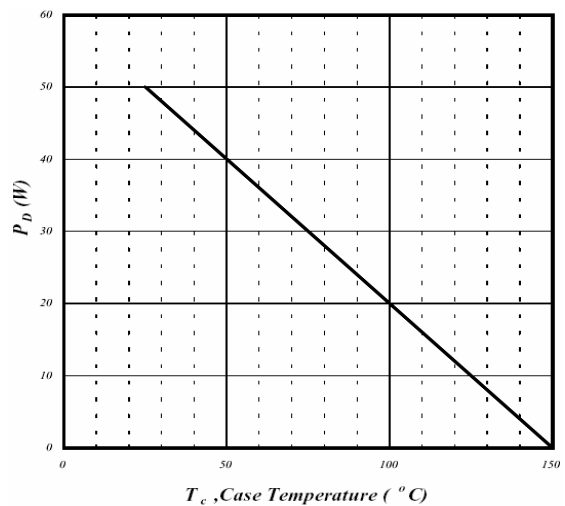

Fig 6. Type Power Dissipation

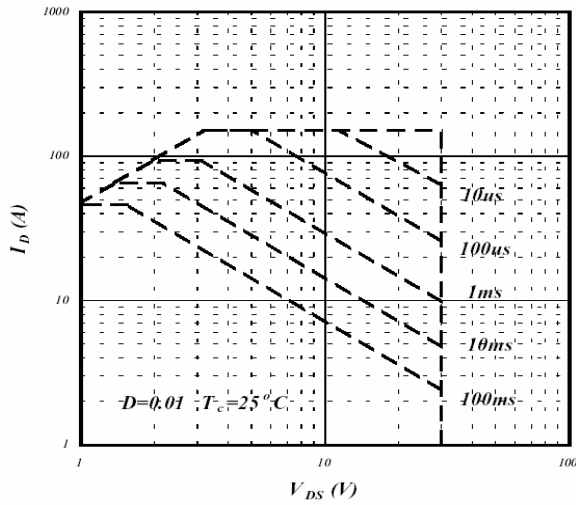

Fig 7. Maximum Safe Operating Area

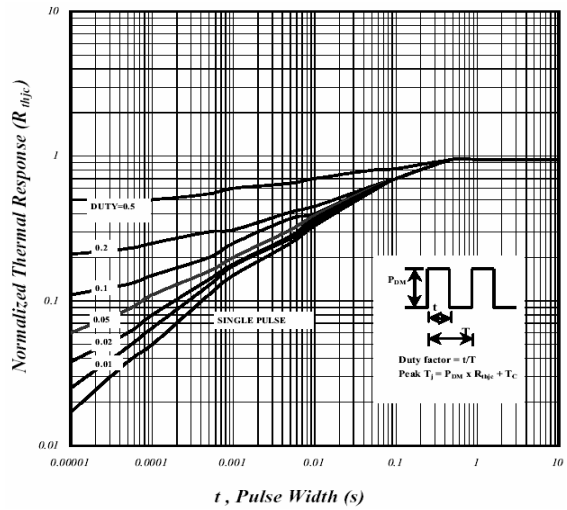

Fig 8. Effective Transient Thermal Impedance

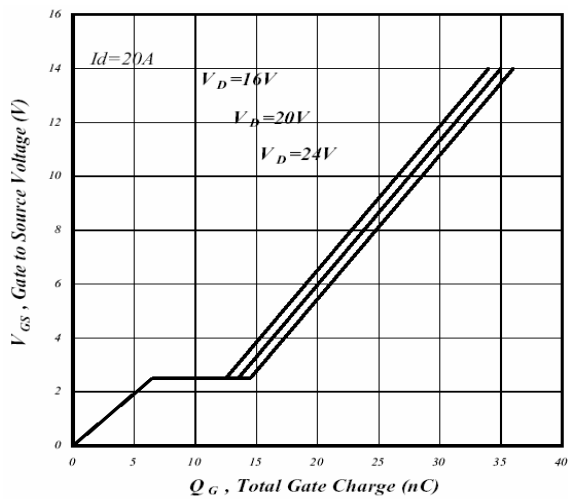

Fig 9. Gate Charge Characteristics

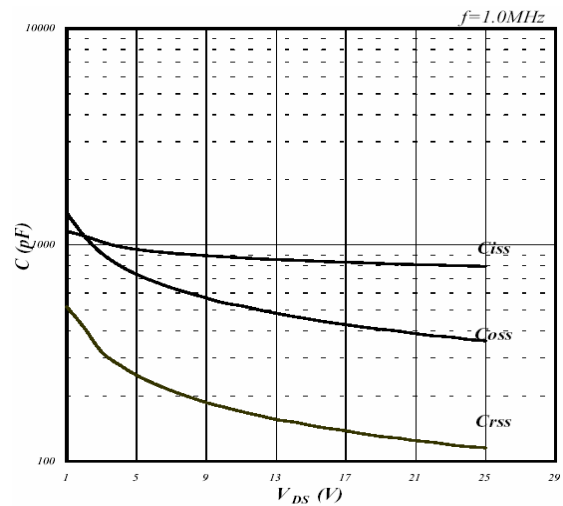

Fig 10. Typical Capacitance Characteristics

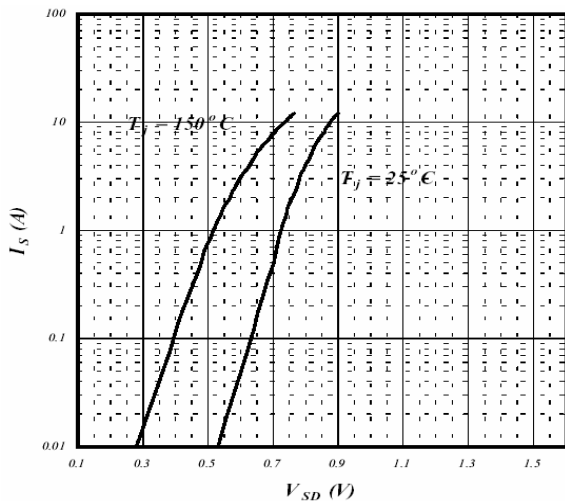

Fig 11. Forward Characteristics of Reverse Diode

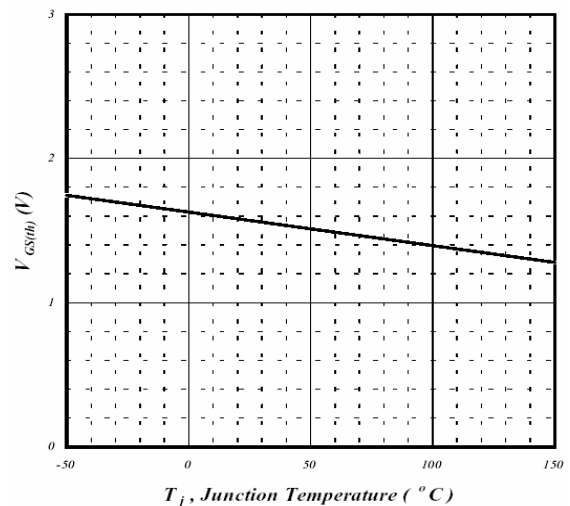
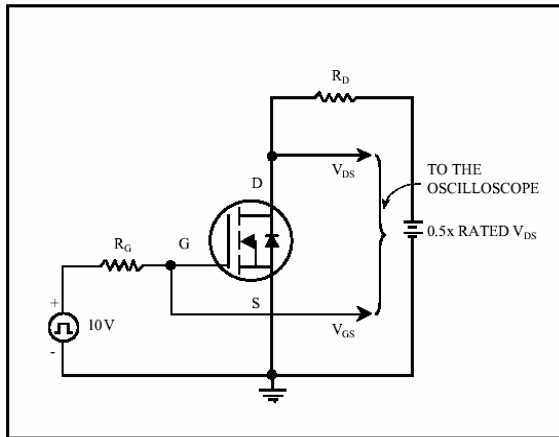
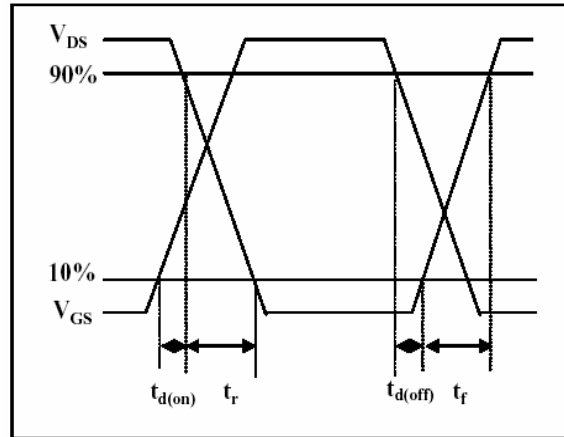

Fig 12. Gate Threshold Voltage v.s. Junction Temperature



**Fig 13. Switching Time Circuit**



**Fig 14. Switching Time Waveform**

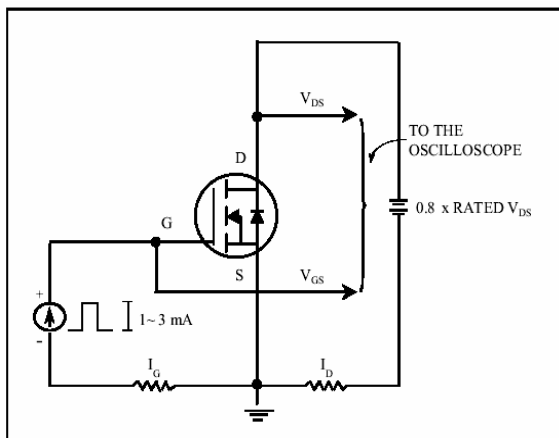

**Fig 15. Gate Charge Circuit**

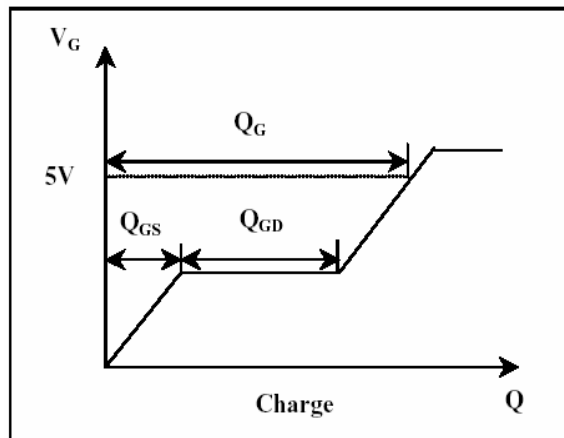

**Fig 16. Gate Charge Waveform**