

No. STSE-CR6083A

<Cat.No.060710>

SPECIFICATIONS FOR NICHIA **RED** LED

MODEL : **NSPRR70ASS**

NICHIA CORPORATION

## 1.SPECIFICATIONS

### (1) Absolute Maximum Ratings (Ta=25°C)

Item	Symbol	Absolute Maximum Rating	Unit
Forward Current	I <sub>F</sub>	70	mA
Pulse Forward Current	I <sub>FP</sub>	200	mA
Reverse Voltage	V <sub>R</sub>	5	V
Power Dissipation	P <sub>D</sub>	203	mW
Operating Temperature	T <sub>opr</sub>	-30 ~ + 85	°C
Storage Temperature	T <sub>stg</sub>	-40 ~ +100	°C
Soldering Temperature	T <sub>sld</sub>	265°C for 5sec.	

I<sub>FP</sub> Conditions : Pulse Width ≤ 10msec. and Duty ≤ 1/10

### (2) Initial Electrical/Optical Characteristics (Ta=25°C)

Item	Symbol	Condition	Typ.	Max.	Unit	
Forward Voltage	V <sub>F</sub>	I <sub>F</sub> =50[mA]	(2.4)	2.9	V	
Reverse Current	I <sub>R</sub>	V <sub>R</sub> = 5[V]	-	50	μA	
Luminous Flux	φ <sub>v</sub>	I <sub>F</sub> =50[mA]	(5.0)	-	lm	
Chromaticity Coordinate*	x	-	I <sub>F</sub> =50[mA]	0.700	-	-
	y	-	I <sub>F</sub> =50[mA]	0.299	-	-

\* Please refer to CIE 1931 chromaticity diagram.

### (3) Ranking (Ta=25°C)

Item	Symbol	Condition	Min.	Max.	Unit	
Luminous Flux	Rank Rc	φ <sub>v</sub>	I <sub>F</sub> =50[mA]	4.8	6.8	lm
	Rank Rb	φ <sub>v</sub>	I <sub>F</sub> =50[mA]	3.4	4.8	lm
	Rank Ra	φ <sub>v</sub>	I <sub>F</sub> =50[mA]	2.4	3.4	lm

\* Luminous Flux Measurement allowance is ± 10%.

### Color Rank (I<sub>F</sub>=50mA, Ta=25°C)

	Rank R			
x	0.67	0.67	0.73	0.73
y	0.27	0.33	0.33	0.27

\* Color Coordinates Measurement allowance is ± 0.01.

\* One delivery will include up to one color rank and three luminous flux ranks of the products.

The quantity-ratio of the ranks is decided by Nichia.

## 2.INITIAL OPTICAL/ELECTRICAL CHARACTERISTICS

Please refer to figure's page.

## 3.OUTLINE DIMENSIONS AND MATERIALS

Please refer to figure's page.

Material as follows ;            Resin(Mold) :    Epoxy Resin (over Silicone Resin + Diffused)  
    Leadframe    :    Ag plating    Copper Alloy

## 4.PACKAGING

- The LEDs are packed in cardboard boxes after packaging in stick.

Please refer to figure's page.

The label on the packing unit shows ; Part Number, Lot Number, Ranking, Quantity

- In order to protect the LEDs from mechanical shock, we pack them in cardboard boxes for transportation.
- The LEDs may be damaged if the boxes are dropped or receive a strong impact against them, so precautions must be taken to prevent any damage.
- The boxes are not water resistant and therefore must be kept away from water and moisture.
- When the LEDs are transported, we recommend that you use the same packing method as Nichia.

## 5.LOT NUMBER

The first six digits number shows **lot number**.

The lot number is composed of the following characters;

○□×××× - △■

- - Year    ( 5 for 2005, 6 for 2006 )
- - Month    ( 1 for Jan., 9 for Sep., A for Oct., B for Nov. )
- ×××× - Nichia's Product Number
- △ - Ranking by Color Coordinates
- - Ranking by Luminous Flux

## 6.RELIABILITY

### (1) TEST ITEMS AND RESULTS

Test Item	Standard Test Method	Test Conditions	Note	Number of Damaged
Resistance to Soldering Heat	JEITA ED-4701 300 302	Tsld=260 ± 5°C, 5sec. 1.6mm from the base of the stopper (Pre treatment 30°C,70%,168hrs.)	1 time	0/50
Solderability	JEITA ED-4701 300 303	Tsld=235 ± 5°C, 5sec. (using flux)	1 time over 95%	0/50
Thermal Shock	JEITA ED-4701 300 307	0°C ~ 100°C 15sec. 15sec.	100 cycles	0/50
Temperature Cycle	JEITA ED-4701 100 105	-40°C ~ 25°C ~ 100°C ~ 25°C 30min. 5min. 30min. 5min.	100 cycles	0/50
Moisture Resistance Cyclic	JEITA ED-4701 200 203	25°C ~ 65°C ~ -10°C 90%RH 24hrs./1cycle	10 cycles	0/50
Terminal Strength (bending test)	JEITA ED-4701 400 401	Load 5N (0.5kgf) 0° ~ 90° ~ 0° bend 2 times	Nonnoticeable damage	0/50
Terminal Strength (pull test)	JEITA ED-4701 400 401	Load 10N (1kgf) 10 ± 1 sec.	Nonnoticeable damage	0/50
High Temperature Storage	JEITA ED-4701 200 201	Ta=100°C	1000hrs.	0/50
Temperature Humidity Storage	JEITA ED-4701 100 103	Ta=60°C, RH=90%	1000hrs.	0/50
Low Temperature Storage	JEITA ED-4701 200 202	Ta=-40°C	1000hrs.	0/50
Steady State Operating Life Condition 1		Ta=25°C, IF=70mA	1000hrs.	0/50
Steady State Operating Life Condition 2		Ta=35°C, IF=50mA	1000hrs.	0/50
Steady State Operating Life of High Humidity Heat		60°C, RH=90%, IF=50mA	500hrs.	0/50
Steady State Operating Life of Low Temperature		Ta=-30°C, IF=50mA	1000hrs.	0/50

### (2) CRITERIA FOR JUDGING DAMAGE

Item	Symbol	Test Conditions	Criteria for Judgement	
			Min.	Max.
Forward Voltage	V <sub>F</sub>	I <sub>F</sub> =50mA	-	U.S.L.*) × 1.1
Reverse Current	I <sub>R</sub>	V <sub>R</sub> =5V	-	U.S.L.*) × 2.0
Luminous Flux	φ <sub>V</sub>	I <sub>F</sub> =50mA	L.S.L.***) × 0.7	-

\*) U.S.L. : Upper Standard Level

\*\*) L.S.L. : Lower Standard Level

## 7.CAUTIONS

### (1) Storage

#### · Storage Conditions

Before opening the package :

The LEDs should be kept at 30°C or less and 90%RH or less. The LEDs should be used within a year. When storing the LEDs, moisture proof packaging with absorbent material (silica gel) is recommended.

After opening the package :

The LEDs should be kept at 30°C or less and 70%RH or less. The LEDs should be soldered within 168 hours (7days) after opening the package. If unused LEDs remain, they should be stored in moisture proof packages, such as sealed containers with packages of moisture absorbent material (silica gel). It is also recommended to return the LEDs to the original moisture proof bag and to reseal the moisture proof bag again.

- If the moisture absorbent material (silica gel) has faded away or the LEDs have exceeded the storage time, baking treatment should be performed using the following conditions.

Baking treatment : more than 24 hours at 85°C

- Nichia LED leadframes are silver plated copper alloy. The silver surface may be affected by environments which contain corrosive substances. Please avoid conditions which may cause the LED to corrode, tarnish or discolor. This corrosion or discoloration may cause difficulty during soldering operations. It is recommended that the LEDs be used as soon as possible.
- Please avoid rapid transitions in ambient temperature, especially, in high humidity environments where condensation can occur.

### (2) Static Electricity

- Static electricity or surge voltage damages the LEDs.

It is recommended that a wrist band or an anti-electrostatic glove be used when handling the LEDs.

- All devices, equipment and machinery must be properly grounded. It is recommended that precautions be taken against surge voltage to the equipment that mounts the LEDs.

(3) Soldering Conditions

- Nichia LEDs uses a copper alloy lead frame which provides a high thermal conductivity. Thermal stress such as soldering heat may reduce the reliability of the product; particular caution should be used to avoid damage prior to and during soldering. The recommended soldering conditions are listed in the following table.
- Solder the LED no closer than 1.6mm from the base of the stopper.
- The mechanical stress by clinching will cause degradation of the reliability on the LEDs. It is important to minimize the mechanical stress on the LEDs. It should be confirmed beforehand that it will not cause any problem when using it.
- Recommended soldering conditions

Dip Soldering		Hand Soldering	
Pre-Heat	120°C Max.	Temperature	350°C Max.
Pre-Heat Time	60 seconds Max.	Soldering Time	3 seconds Max.
Solder Bath Temperature	260°C Max.	Position	No closer than 1.6 mm from the base of the stopper.
Dipping Time	5 seconds Max.		
Dipping Position	No lower than 1.6 mm from the base of the stopper.		

- Although the recommended soldering conditions are specified in the above table, dip or hand soldering at the lowest possible temperature is desirable for the LEDs.
- A rapid-rate process is not recommended for cooling the LEDs down from the peak temperature.
- Dip soldering should not be done more than one time.
- Hand soldering should not be done more than one time.
- Do not apply any stress to the lead particularly when heated.
- The LEDs must not be repositioned after soldering.
- After soldering the LEDs, the epoxy bulb should be protected from mechanical shock or vibration until the LEDs return to room temperature.
- Direct soldering onto a PC board should be avoided. Mechanical stress to the resin may be caused from warping of the PC board or from the clinching and cutting of the leadframes. When it is absolutely necessary, the LEDs may be mounted in this fashion but the User will assume responsibility for any problems. Direct soldering should only be done after testing has confirmed that no damage, such as wire bond failure or resin deterioration, will occur. Nichia's LEDs should not be soldered directly to double sided PC boards because the heat will deteriorate the epoxy resin.
- When it is necessary to clamp the LEDs to prevent soldering failure, it is important to minimize the mechanical stress on the LEDs.
- Cut the LED leadframes at room temperature. Cutting the leadframes at high temperatures may cause failure of the LEDs.

(4) Heat Generation

- Thermal design of the end product is of paramount importance. Please consider the heat generation of the LED when making the system design. The coefficient of temperature increase per input electric power is affected by the thermal resistance of the circuit board and density of LED placement on the board, as well as other components. It is necessary to avoid intense heat generation and operate within the maximum ratings given in this specification.
- The operating current should be decided after considering the ambient maximum temperature of LEDs.

(5) Cleaning

- It is recommended that isopropyl alcohol be used as a solvent for cleaning the LEDs. When using other solvents, it should be confirmed beforehand whether the solvents will dissolve the resin or not. Freon solvents should not be used to clean the LEDs because of worldwide regulations.
- Do not clean the LEDs by the ultrasonic. When it is absolutely necessary, the influence of ultrasonic cleaning on the LEDs depends on factors such as ultrasonic power and the assembled condition. Before cleaning, a pre-test should be done to confirm whether any damage to the LEDs will occur.

(6) Safety Guideline for Human Eyes

- In 1993, the International Electric Committee (IEC) issued a standard concerning laser product safety (IEC 825-1). Since then, this standard has been applied for diffused light sources (LEDs) as well as lasers. In 1998 IEC 60825-1 Edition 1.1 evaluated the magnitude of the light source. In 2001 IEC 60825-1 Amendment 2 converted the laser class into 7 classes for end products. Components are excluded from this system. Products which contain visible LEDs are now classified as class 1. Products containing UV LEDs are class 1M. Products containing LEDs can be classified as class 2 in cases where viewing angles are narrow, optical manipulation intensifies the light, and/or the energy emitted is high. For these systems it is recommended to avoid long term exposure. It is also recommended to follow the IEC regulations regarding safety and labeling of products.

(7) Others

- NSPRR70AS complies with RoHS Directive.
- Care must be taken to ensure that the reverse voltage will not exceed the absolute maximum rating when using the LEDs with matrix drive.
- Flashing lights have been known to cause discomfort in people; you can prevent this by taking precautions during use. Also, people should be cautious when using equipment that has had LEDs incorporated into it.
- The LEDs described in this brochure are intended to be used for ordinary electronic equipment (such as office equipment, communications equipment, measurement instruments and household appliances). Consult Nichia's sales staff in advance for information on the applications in which exceptional quality and reliability are required, particularly when the failure or malfunction of the LEDs may directly jeopardize life or health (such as for airplanes, aerospace, submersible repeaters, nuclear reactor control systems, automobiles, traffic control equipment, life support systems and safety devices).
- User shall not reverse engineer by disassembling or analysis of the LEDs without having prior written consent from Nichia. When defective LEDs are found, the User shall inform Nichia directly before disassembling or analysis.
- The formal specifications must be exchanged and signed by both parties before large volume purchase begins.
- The appearance and specifications of the product may be modified for improvement without notice.

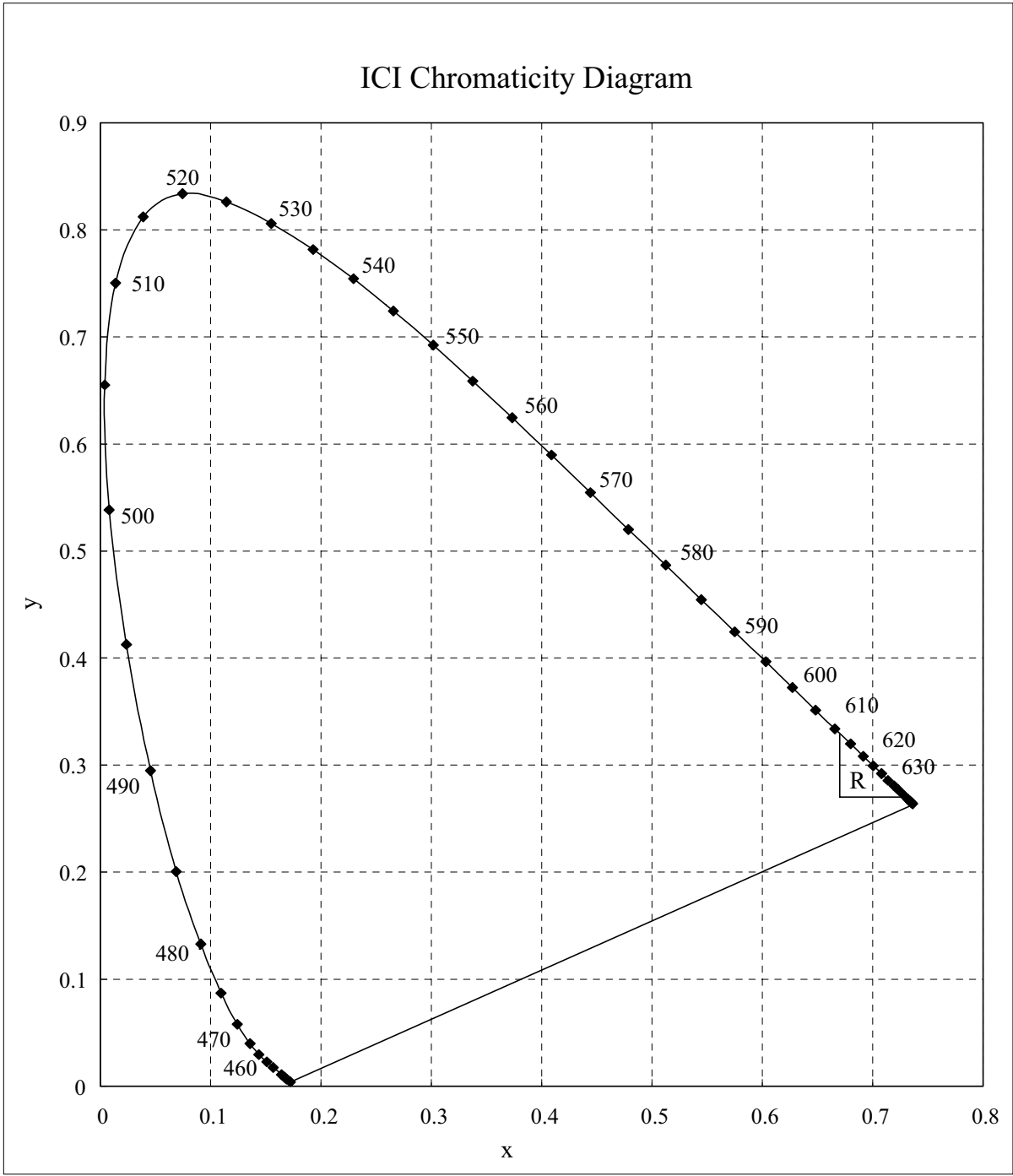

\* Color Coordinates Measurement allowance is  $\pm 0.01$ .



■ Forward Voltage vs. Forward Current

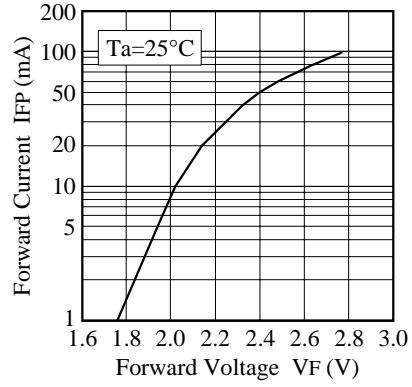

■ Forward Current vs. Relative Luminous Flux

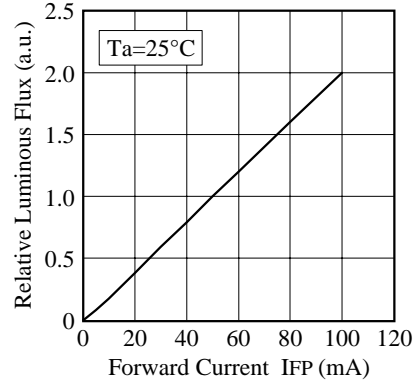

■ Duty Ratio vs. Allowable Forward Current

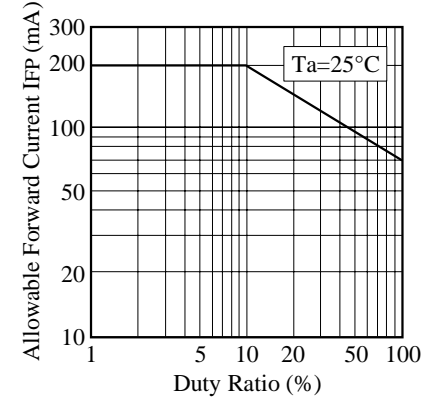

■ Ambient Temperature vs. Forward Voltage

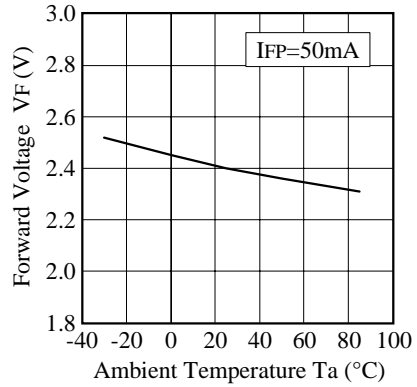

■ Ambient Temperature vs. Relative Luminous Flux

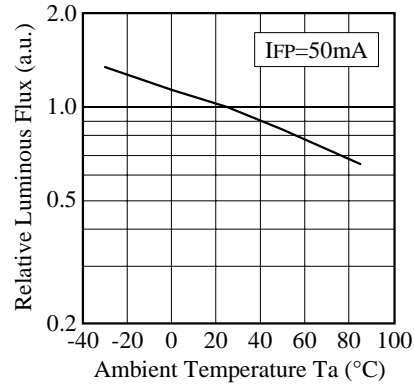

■ Ambient Temperature vs. Allowable Forward Current

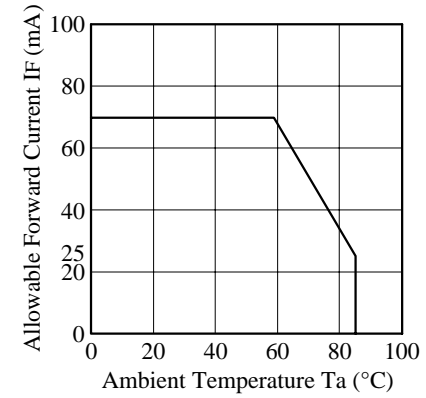

<b>NICHIA CORPORATION</b>	Model	NSPRR70AS
	Title	CHARACTERISTICS
	No.	060703653941

■ Ambient Temperature vs. Chromaticity Coordinate ( $\lambda_D$ )

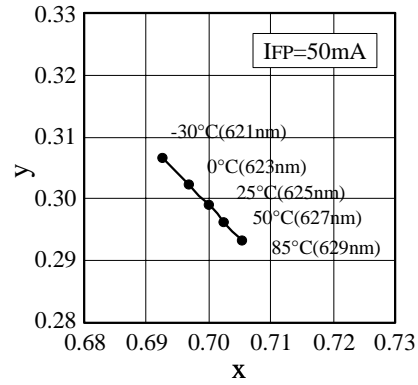

■ Spectrum

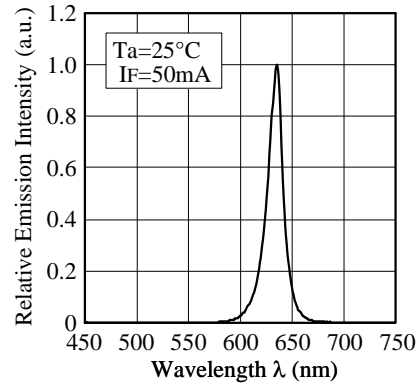

■ Ambient Temperature vs. Dominant Wavelength

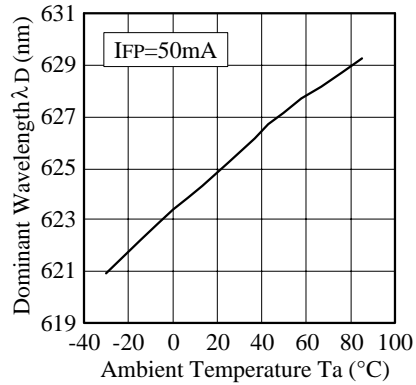

■ Forward Current vs. Dominant Wavelength

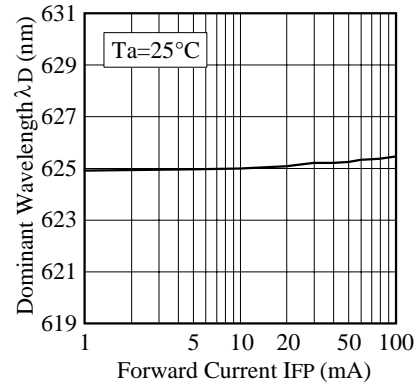

■ Directivity

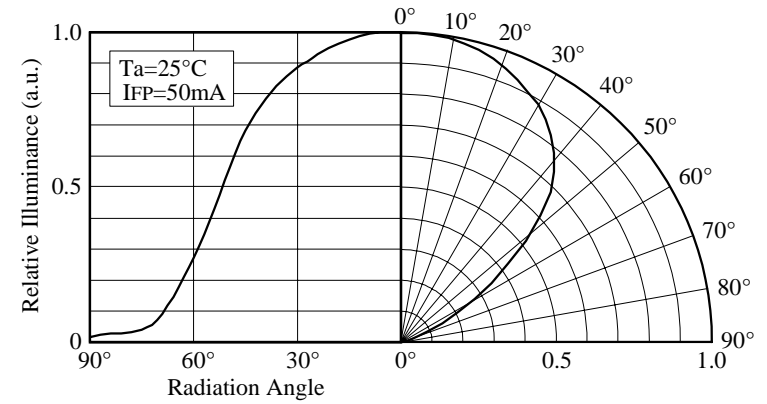

<b>NICHIA CORPORATION</b>	Model	NSPRR70AS
	Title	CHARACTERISTICS
	No.	060703653951

Internal Circuit

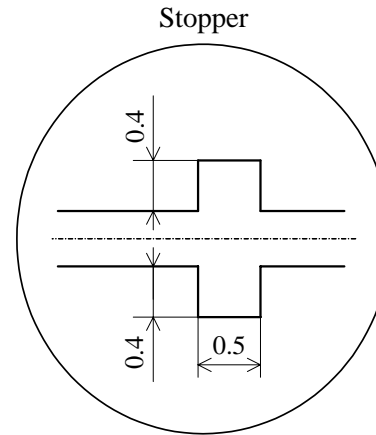
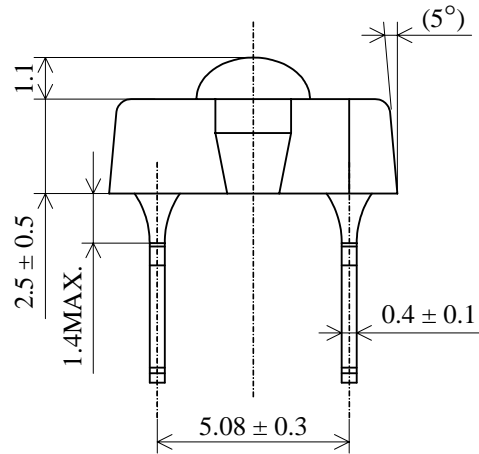
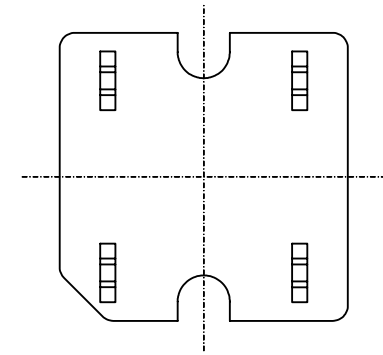
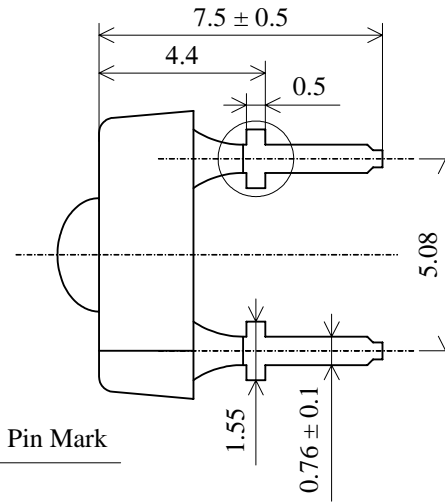
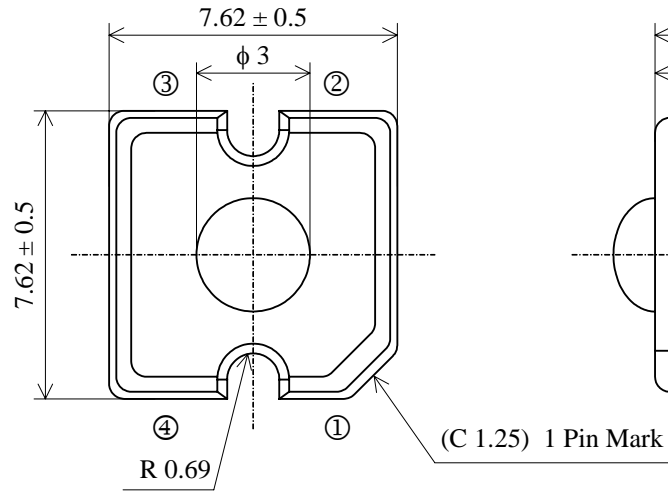
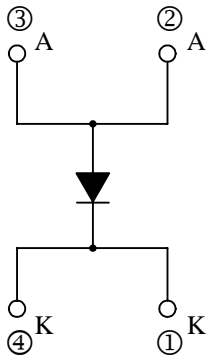

ITEM	MATERIALS
RESIN	Epoxy Resin (over Silicone Resin + Diffused)
LEAD FRAME	Ag Plating Copper Alloy

Remark:

Please note that the bare copper alloy showing at the cut end of the lead frame may be corroded under certain conditions. LEDs have some sharp edges and points, particularly lead frames. Please handle with care so as to avoid injuries.

<b>NICHIA CORPORATION</b>	Model	NSPRR70AS	Unit mm
	Title	OUTLINE DIMENSIONS	
	No.	060703653961	5/1 Scale
			Allow ±0.2

Cross Sectional image of stick

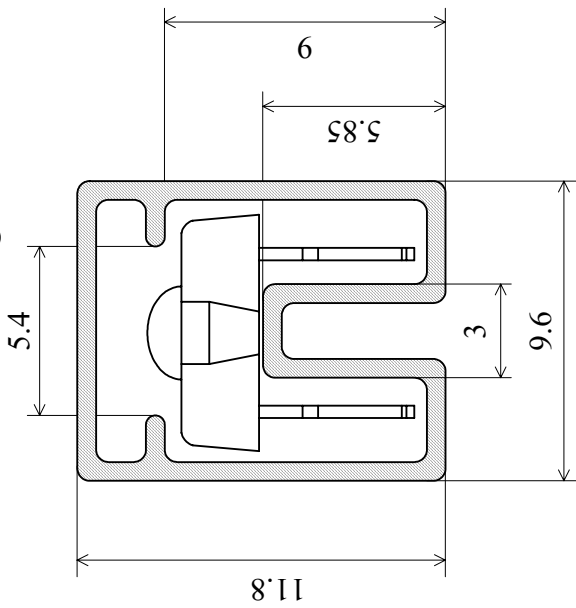

\*1  $t = 0.6 \pm 0.1$ mm  
 \*2 Warp : 1mm Max.

Whole image of stick

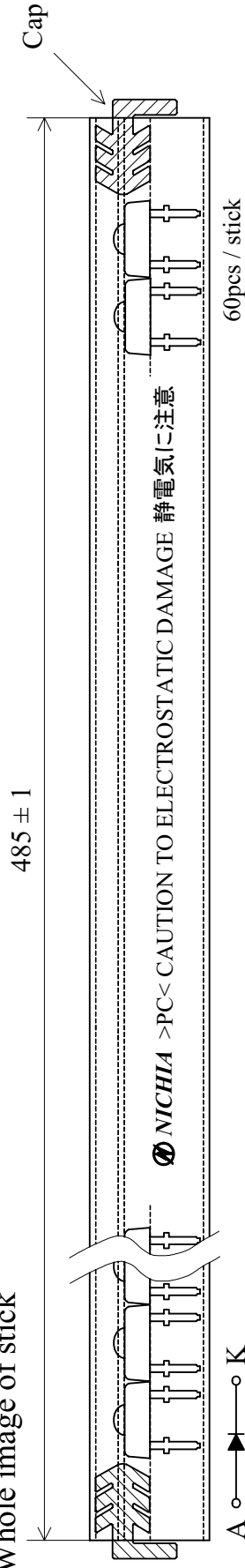

NICHIA CORPORATION	Model	NSPxR70xSS	Unit	mm
	Title	STICK DIMENSIONS	Scale	Allow ±0.2
	No.	050725436072		

The stick and moisture absorbent material are put in the moisture proof foil bag and then heat sealed.

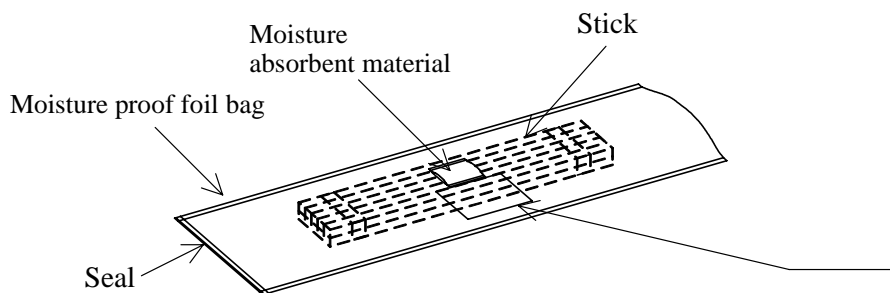

Label

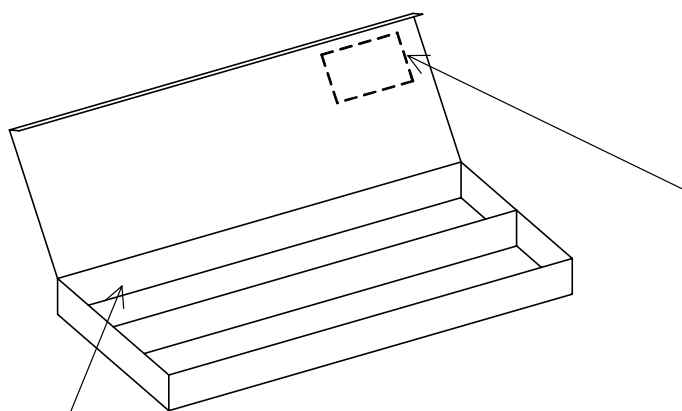
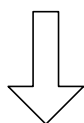

Label

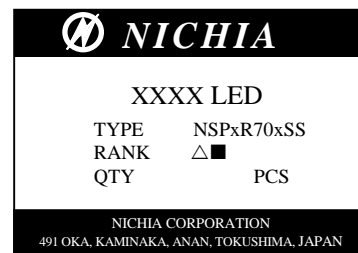

Empty space in the box is filled with cushion material.

Packing unit

	Stick/bag	Quantity/bag (pcs)
Moisture proof foil bag	10 stick Max.	600 MAX.

Cardboard box	Dimensions (mm)	Stick/box	Quantity/box (pcs)
Cardboard box M	590×277×120×4t	100 stick MAX.	6,000 MAX.
Cardboard box 1/2L	613×298×268×7t	200 stick MAX.	12,000 MAX.
Cardboard box L	613×298×518×7t	400 stick MAX.	24,000 MAX.

<b>NICHIA CORPORATION</b>	Model	NSPxR70xSS	/
	Title	PACKING	
	No.	060707436083	